

**Case IH Patriot 4430 and Tital XX30
Series Steering Ready - Model Year
2013 & Newer
SmarTrax™ Installation Manual**

P/N 016-5032-026 Rev B

06/15

E23433

Disclaimer

While every effort has been made to ensure the accuracy of this document, Raven Industries assumes no responsibility for omissions and errors. Nor is any liability assumed for damages resulting from the use of information contained herein.

Raven Industries shall not be responsible or liable for incidental or consequential damages or a loss of anticipated benefits or profits, work stoppage or loss, or impairment of data arising out of the use, or inability to use, this system or any of its components. Raven Industries shall not be held responsible for any modifications or repairs made outside our facilities, nor damages resulting from inadequate maintenance of this system.

As with all wireless and satellite signals, several factors may affect the availability and accuracy of wireless and satellite navigation and correction services (e.g. GPS, GNSS, SBAS, etc.). Therefore, Raven Industries cannot guarantee the accuracy, integrity, continuity, or availability of these services and cannot guarantee the ability to use Raven systems, or products used as components of systems, which rely upon the reception of these signals or availability of these services. Raven Industries accepts no responsibility for the use of any of these signals or services for other than the stated purpose.

Chapter 1	<i>Important Safety Information</i>	1
	Hydraulic Safety	2
	Electrical Safety	2
Chapter 2	<i>Introduction</i>	3
	Preparing for Installation	3
	Recommendations	4
	Point of Reference	4
	Updates	4
	Kit Contents	5
	Case IH Patriot 4430 or Titan XX30 Series without Phoenix 200 Antenna	5
	Case IH Patriot 4430 or Titan XX30 Series with Phoenix 200 Antenna	7
Chapter 3	<i>Cab Component Installation</i>	11
	Install the SmarTrax Node	11
	Node Mounting Locations	11
	Install the SmarTrax Node - Preferred Mounting Method	12
	Install the SmarTrax Node - Secondary Mounting Method	16
	Check the Machine's Flow Switch Configuration	21
	Install the Phoenix 200 Antenna (If Applicable)	22
	Enable Switch	22
	Calibrate the SmarTrax System	23

CHAPTER

1

*Important Safety
Information*

NOTICE

Read this manual and the operation and safety instructions included with your implement and/or controller carefully before installing the SmarTrax™ system.

- Follow all safety information presented within this manual.
- If you require assistance with any portion of the installation or service of your Raven equipment, contact your local Raven dealer for support.
- Follow all safety labels affixed to the SmarTrax system components. Be sure to keep safety labels in good condition and replace any missing or damaged labels. To obtain replacements for missing or damaged safety labels, contact your local Raven dealer.

When operating the machine after installing SmarTrax, observe the following safety measures:

- Be alert and aware of surroundings.
- Do not operate SmarTrax or any agricultural equipment while under the influence of alcohol or an illegal substance.
- Remain in the operator's position in the machine at all times when SmarTrax is engaged.
- Disable SmarTrax when exiting the operator's seat and machine.
- Do not drive the machine with SmarTrax enabled on any public road.
- Determine and remain a safe working distance from other individuals. The operator is responsible for disabling SmarTrax when the safe working distance has diminished.
- Ensure SmarTrax is disabled prior to starting any maintenance work on SmarTrax or the machine.

 **WARNING**

- When starting the machine for the first time after installing SmarTrax, be sure that all persons stand clear in case a hose has not been properly tightened.
- The machine must remain stationary and switched off during SmarTrax installation or maintenance.

 **CAUTION**

Hydraulic Safety

- Raven Industries recommends that appropriate protective equipment be worn at all times when working on the hydraulic system.
- Never attempt to open or work on a hydraulic system with the equipment running. Care should always be taken when opening a system that has been previously pressurized.
- When disconnecting the hydraulic hoses or purging is required, be aware that the hydraulic fluid may be extremely hot and under high pressure. Caution must be exercised.
- Any work performed on the hydraulic system must be done in accordance with the machine manufacturer's approved maintenance instructions.
- When installing SmarTrax hydraulics or performing diagnostics, maintenance, or routine service, ensure that precautions are taken to prevent any foreign material or contaminants from being introduced into the machine's hydraulic system. Objects or materials that are able to bypass the machine's hydraulic filtration system will reduce performance and possibly damage the SmarTrax valve.

Electrical Safety

- Always verify that the power leads are connected to the correct polarity as marked. Reversing the power leads could cause severe damage to the equipment.
- Ensure that the power cable is the last cable to be connected.

CHAPTER

2

Introduction

Congratulations on your purchase of the SmarTrax system! This system is designed to provide cutting-edge, hands-free steering of the machine via Global Positioning System (GPS) coordinates.

This manual applies to the following machines:

MAKE: Case IH

MODEL: Patriot 4430 and Titan XX30 Series - Steering Ready

YEAR: 2013 & Newer

FIGURE 1. Case IH Patriot 4430 and Titan 3530 & 4530



Preparing for Installation

Before installing the SmarTrax system, park the machine where the ground is level, clean, and dry. Turn off the machine and leave it turned off for the duration of the installation process. Bleed pressure from the hydraulic system by loosening the hydraulic fittings slowly, where applicable.

During the installation process, follow good safety practices. Be sure to carefully read the instructions in this manual as you complete the installation process.

Recommendations

Raven Industries recommends the following best practices when installing or operating the SmarTrax system for the first time, at the start of the season, or when moving the SmarTrax system to another machine:

- Install the GPS antenna in the recommended location. Refer to the following table for the machine-specific antenna mounting location.

Note: *If your machine is not listed, install the antenna on the front-center of the cab.*

Machine Preset	Antenna X Position (left to right)	Antenna Y Position (from the rear wheel axle to the antenna position on the cab)	Antenna Z Position (ground to top of antenna)
Case IH FLX 30x0/35x0	Centered	14.5 ft./4.42 m	12.25 ft./3.73 m
Case IH FLX 40x0/45x0	Centered	15 ft./4.57 m	11.83 ft./3.61 m
Case IH SPX 33/44X0 120' Booms	Centered	14.5 ft./4.42 m	12 ft./3.66 m
Case IH SPX4260 and 44x0	Centered	14.5 ft./4.42 m	12 ft./3.66 m

- Ensure the machine's hydraulic filters have been recently changed and there are no issues with the machine's hydraulic system (e.g., pump issues, faulty hydraulic motors, fine metal deposits in the hydraulic hoses, etc.).
- Ensure the machine's hydraulic system is using fresh oil and debris is flushed from the hydraulic hoses, valves, and filters.

Raven Industries recommends the following best practices when installing the SmarTrax system:

- Use part numbers to identify the parts.
- Do not remove the plastic wrap from a part until it is necessary for installation.
- Do not remove plastic caps from a part until it is necessary for installation.

Point of Reference

The instructions in this manual assume that you are standing behind the machine, looking toward the cab.

Updates

Software and manual updates are available on the Raven Applied Technology website:

<http://www.ravenhelp.com>

At Raven Industries, we strive to make your experience with our products as rewarding as possible. One way to improve this experience is to provide us with feedback on this manual.

Your feedback will help shape the future of our product documentation and the overall service we provide. We appreciate the opportunity to see ourselves as our customers see us and are eager to gather ideas on how we have been helping or how we can do better.

To serve you best, please send an email with the following information to

techwriting@ravenind.com

- Case IH Patriot 4430 and Titan XX30 Series - Steering Ready, Model Year 2013 & Newer SmarTrax™ Installation Manual
- Manual No. 016-5032-026 Rev. B
- Any comments or feedback (include chapter or page numbers if applicable).
- Let us know how long have you been using this or other Raven products.

We will not share your email or any information you provide with anyone else. Your feedback is valued and extremely important to us.

Thank you for your time.

2

Kit Contents

This section contains a list of the components that are included in the SmarTrax kit. Before beginning the SmarTrax installation, compare the items in the kit with the components on this list. If you have questions about the kit, contact your Raven dealer.

Case IH Patriot 4430 or Titan XX30 Series without Phoenix 200 Antenna

TABLE 1. SmarTrax Kit (P/N 117-5032-026 or 117-5032-028)

Picture	Item Description	Part Number	Qty.
Not Pictured	Manual - SmarTrax and SmartSteer Calibration & Operation	016-0171-277	1
Not Pictured	Manual - Case IH Patriot 4430 and Titan XX30 Series Steering Ready SmarTrax Installation	016-5032-026	1
	Node - SmarTrax RTK	063-0173-228	1

TABLE 1. SmarTrax Kit (P/N 117-5032-026 or 117-5032-028)















Picture	Item Description	Part Number	Qty.
	Bracket - Node Mounting	107-0171-954	1
	Bracket - Node Support	107-0171-960	1
	Bracket - Node Mounting	107-0172-084	1
	Cable - 6" Adapter Sense	115-0172-084	1
	Cable - Node Harness	115-4001-190 or 115-4001-195	1
	Screw - #10 x 3/4" Slotted Head Self-Tapping	311-0001-321	1
	Bolt - 1/4"-20 x 1-1/4" Hex	311-0050-106	2
	Bolt - 5/16"-18 x 7/8" Hex	311-0052-104	3
	Nut - 3/8" Zinc Flanged Lock	312-1001-164	3
	Nut - 5/16"-18 x 7/8" Hex	312-1001-169	3
	Nut - 1/4"-20 Nylon Insert Lock	312-4000-057	2

TABLE 1. SmarTrax Kit (P/N 117-5032-026 or 117-5032-028)

Picture	Item Description	Part Number	Qty.
	Nut - M6 Lock	312-4000-207	4
	Washer - 1/4" Split Lock	313-1000-016	4
	Washer - 0.250" ID x 0.562" OD x 0.065" Thick	313-2300-009	6

Case IH Patriot 4430 or Titan XX30 Series with Phoenix 200 Antenna

TABLE 2. SmarTrax Kit (P/N 117-5032-027 or 117-5032-029)







Picture	Item Description	Part Number	Qty.
Not Pictured	Manual - SmarTrax and SmartSteer Calibration & Operation	016-0171-277	1
Not Pictured	Manual - Case IH Patriot 4430 and Titan XX30 Series Steering Ready SmarTrax Installation	016-5032-026	1
	Node - SmarTrax RTK	063-0173-228	1
	Bracket - Node Mounting	107-0171-954	1
	Bracket - Node Support	107-0171-960	1
	Bracket - Node Mounting	107-0172-084	1

TABLE 2. SmarTrax Kit (P/N 117-5032-027 or 117-5032-029)

Picture	Item Description	Part Number	Qty.
	Antenna - Phoenix 200 Helix	063-0172-719	1
	Cable - Case IH Interface to SmarTrax RTK Node	115-0172-019	1
	Cable - Node Harness	115-4001-190 or 115-4001-195	1
	Screw - #10 x 3/4" Slotted Head Self-Tapping	311-0001-321	1
	Bolt - 1/4"-20 x 1-1/4" Hex	311-0050-106	2
	Bolt - 5/16"-18 x 7/8" Hex	311-0052-104	3
	Nut - 3/8" Zinc Flanged Lock	312-1001-164	3
	Nut - 5/16"-18 x 7/8" Hex	312-1001-169	3
	Nut - 1/4"-20 Nylon Insert Lock	312-4000-057	2
	Nut - M6 Lock	312-4000-207	4

TABLE 2. SmarTrax Kit (P/N 117-5032-027 or 117-5032-029)

Picture	Item Description	Part Number	Qty.
	Washer - 1/4" Split Lock	313-1000-016	4
	Washer - 0.250" ID x 0.562" OD x 0.065" Thick	313-2300-009	2

Install the SmarTrax Node

Node Mounting Locations

FIGURE 1. Node Mounting

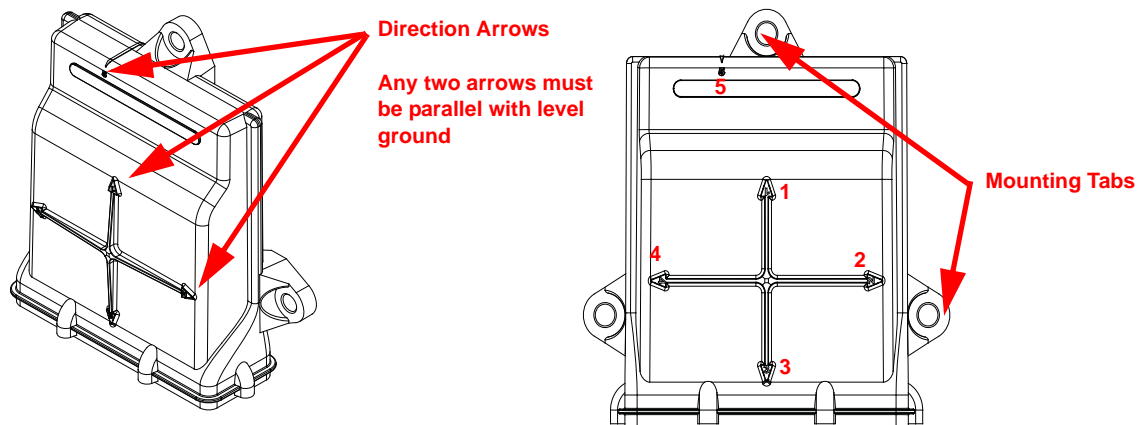

When choosing the location for the SmarTrax node, consider the following points:

- Mount the SmarTrax node inside the machine's cab on a flat, level surface for proper performance and cable connection.
- One of the six numbered direction arrows on the node must be oriented in the direction of forward vehicle travel, one arrow pointing straight up, and two of the arrows parallel to the ground.

Note: *Make a note of the number of the arrow that is oriented in the direction of forward vehicle travel. This number will be needed during the SmarTrax calibration process.*

- The node mounting location must not create tripping hazards.
- Mount the node in a location where it will not be kicked or jarred during normal equipment operation.
- The location must allow cable routing to avoid crimping or damaging the cables or the node connections.
- Securely fasten the node using bolts or screws through at least two of the three mounting holes. When mounted properly, the node should not become loose or rotate.

Install the SmarTrax Node - Preferred Mounting Method

FIGURE 2. Instructional Seat Mounting Screws



1. Uninstall the instructional seat cushion by removing the screws that secure it to the frame.
2. Remove any contents from under the instructional seat.

FIGURE 3. Floor Mat Removed from Cab



3. Lift the floor mat from the floor in front of the seat.

FIGURE 4. Removing Instructional Seat Molding

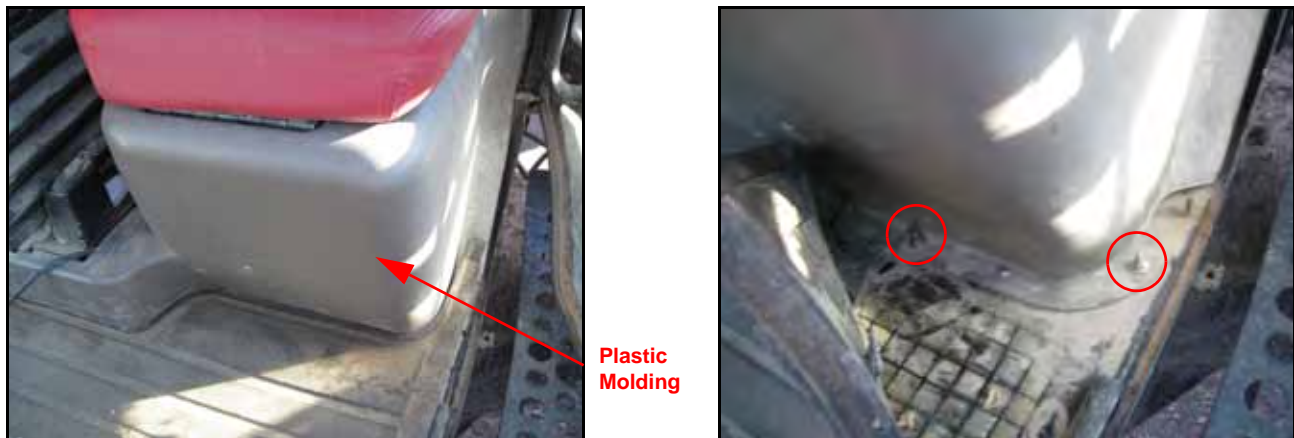

4. Remove the plastic molding under the instructional seat by removing the nuts and bolts securing it.

FIGURE 5. Node Mounted to Mounting Plate



5. Mount the SmarTrax node (P/N 063-0173-228) to the node mounting bracket (P/N 107-0172-084) using three 3/8"-16 zinc flanged lock nuts (P/N 312-1001-164).
6. Place the node in the instructional seat compartment so the connectors face away from the operator's seat.
7. Secure the node mounting bracket to the existing bolts in the floor of the cab using four 1/4" zinc split lock washers (P/N 313-1000-016), four washers (P/N 313-2300-009), and four M6 lock nuts (P/N 312-4000-207).

FIGURE 6. Node Harness Installed on Node



8. Install the two large, rectangular connectors of the node cable (P/N 115-4001-190 or 115-4001-195) into the correct ports of the node, tightening the bolts on the harness connectors to secure the connections.

Note: *The connectors should be facing the window.*

9. Locate the ENABLE connector on the node harness and connect it to the foot switch cable connector.
10. Route the node cable into the fuse box and behind the operator's seat.
11. Connect the DGPS connector to the GPS receiver.

FIGURE 7. DGPS OUT Connector Routed Under Operator's Seat



12. Route the DGPS OUT connector out the right corner of the operator's seat base and under the right arm rest.

FIGURE 8. Convenience Tray Removed



13. Remove the convenience tray from the right-rear corner of the cab.
14. Locate the connectors labeled POWER GND PORT, PRODUCT CAN, and RAVEN INTERFACE on the machine's harness in the convenience tray compartment and route them to the node harness.
15. Connect the machine's POWER GND PORT to the mating 6-pin POWER connector on the node harness.
16. Remove the dust cap from the 4-pin PRODUCT CAN connector on the machine's harness and connect it to the mating 4-pin CAN connector on the node harness.
17. Connect the machine's RAVEN INTERFACE connector to the mating 37-pin connector on the node harness.

FIGURE 9. DGPS OUT Connected to Console Receiver Connection



18. Connect the DGPS connector on the node harness to the GPS receiver.
19. Route the DGPS OUT connector on the node harness to the A-post at the front-right corner of the cab.
20. Connect the DGPS OUT connector to the Viper Pro or Envizio Pro receiver connection.

Install the SmarTrax Node - Secondary Mounting Method

FIGURE 10. Node Mounting Location



1. Identify the node mounting location on the bracket to the right of the operator's seat.
2. If equipped with a traction control foot pedal, remove the existing nut, bolt, and spacer from the bracket that holds the pedal in place.

FIGURE 11. Hole Drilled in Machine's Bracket



3. Align the hole in the node mounting bracket (P/N 107-0171-954) with the hole in the machine's bracket.
4. Using the node mounting bracket as a template, drill a second hole in the machine's bracket.

FIGURE 12. Node Mounting Bracket Installed

5. If equipped with a traction control foot pedal, reinstall the machine's spacer between the traction control pedal and the machine's bracket.
6. Secure the node mounting bracket to the machine's bracket using two 1/4"-20 x 1-1/4" hex bolts (P/N 311-0050-106), two 1/4" flat washers (P/N 313-2300-009), and two 1/4"-20 nylon insert lock nuts (P/N 312-4000-057).

FIGURE 13. Node Installed on Mounting Bracket

7. Align the holes in the node with the holes in the node mounting bracket.
8. Install two 5/16"-18 x 7/8" hex bolts (P/N 311-0052-104) and two 5/16" zinc flanged lock nuts (P/N 312-1001-169) in the top and right node mounting tabs.

FIGURE 14. Node Support Bracket Secured to Node Mounting Bracket



9. Position the node support bracket (P/N 107-0171-960) so that the hole aligns with the hole in the bottom node mounting tab.
10. Secure the node support bracket to the node mounting bracket by inserting a 5/16"-18 x 7/8" hex bolt (P/N 311-0052-104) through both brackets and installing one 5/16" zinc flanged lock nut (P/N 312-1001-169).

FIGURE 15. Node Support Bracket Secured to Cab Floor



11. Secure the node support bracket to the cab floor using one #10 x 3/4" self-tapping slotted hex head screw (P/N 311-0001-321).

FIGURE 16. Node Harness Installed on Node



1. Install the two large, rectangular connectors of the node harness (P/N 115-4001-190 or 115-4001-195) into the correct ports of the node, tightening the bolts on the harness connectors to secure the connections.

FIGURE 17. Node Harness Routing



2. Route the node harness into the blower fan compartment located in the right-rear corner of the cab.

FIGURE 18. Convenience Tray Removed



3. Remove the convenience tray from the right-rear corner of the cab.
4. Locate the connectors labeled POWER GND PORT, PRODUCT CAN, and RAVEN INTERFACE on the machine's harness in the convenience tray compartment and route them to the node harness.
5. Connect the machine's POWER GND PORT to the mating 6-pin POWER connector on the node harness.
6. Remove the dust cap from the 4-pin PRODUCT CAN connector on the machine's harness and connect it to the mating 4-pin CAN connector on the node harness.
7. Connect the machine's RAVEN INTERFACE connector to the mating 37-pin connector on the node harness.

FIGURE 19. DGPS OUT Connected to Console Receiver Connection



8. Connect the DGPS connector on the node harness to the GPS receiver.
9. Route the DGPS OUT connector on the node harness to the A-post at the front-right corner of the cab.
10. Connect the DGPS OUT connector to the Viper Pro or Envizio Pro receiver connection.

Check the Machine's Flow Switch Configuration

Note: A change to the flow switch in Case IH Patriot Steering-Ready machines causes the disengage signal to not change state. Complete the following steps to ensure the disengage signal is fully functional.

FIGURE 20. Flow Switch Configuration

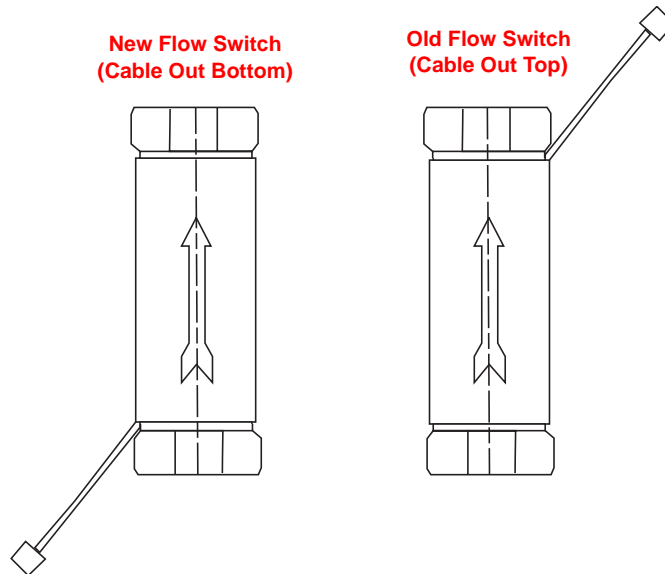

1. Identify the machine's flow switch configuration as shown in Figure 10 above.
 - a. If the cable is coming out of the top of the flow switch, proceed to *Install the Phoenix 200 Antenna (If Applicable)* below.
 - b. If the cable is coming out of the bottom of the flow switch, proceed to the next step.
2. Disconnect the flow switch cable from the machine's hydraulic valve.
3. Install the 6" sense adapter cable (P/N 115-0172-218) between the flow switch cable connection and the machine's hydraulic valve.
4. Go to www.ravenhelp.com > **Software Updates** > **Guidance and Steering** > **SmarTrax™** and **SmarTrax™ RTK** to download software version 6.0.41.
5. Follow the directions to update the SmarTrax software.
6. In the field computer, select the machine preset applicable to the machine model.
 - CIH SPX 2240 2014
 - CIH SPX 3320/3330 2014
 - CIH SPX 4430 2014

Install the Phoenix 200 Antenna (If Applicable)

FIGURE 21. Phoenix 200 Antenna Installed

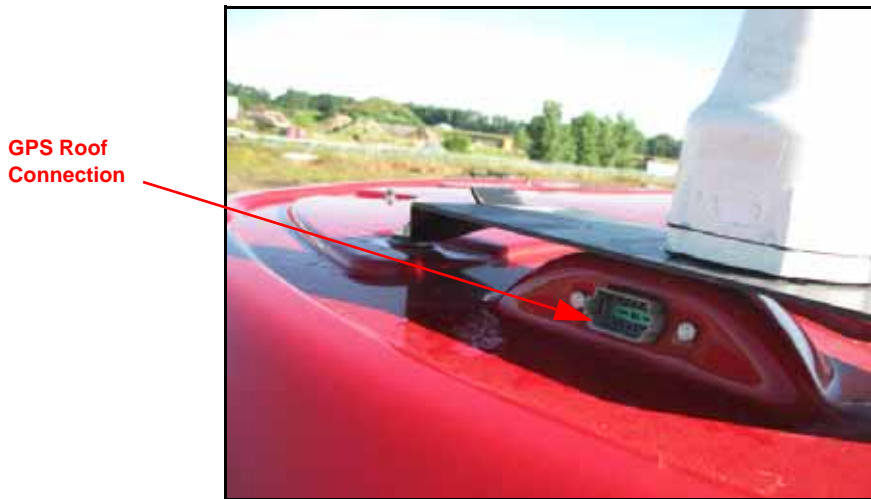

1. Install the Phoenix 200 antenna (P/N 063-0172-719) on the existing mounting plate on the cab roof.
2. Connect the Phoenix 200 to Case harness cable (P/N 115-0172-019) between the antenna and the GPS roof connection.
3. Connect the CASE GPS connection and the DGPS IN connection from the node harness (P/N 115-4001-190 or 115-4001-195) cable together.

Enable Switch

FIGURE 22. Enable Switch.



A factory-installed switch is installed on the floor of the machine's cab. Use this enable switch to engage and disengage the SmarTrax system after installation and calibration of the system is complete. Refer to the

SmarTrax and SmartSteer Calibration & Operation Manual (P/N 016-0171-277) for instructions on performing the system calibration.

Calibrate the SmarTrax System

Refer to the SmarTrax and SmartSteer Calibration & Operation Manual (P/N 016-0171-277) for instructions on calibrating the SmarTrax system, adjusting system settings, and system operation.

C

Cab Component Installation 11

- Check the Machine's Flow Switch Configuration 21
- Enable Switch 22
- Install the Phoenix 200 Antenna 22
- Installing the SmarTrax Node 11

I

Important Safety Information 1

Introduction

- Kit Contents 5
 - Case IH Patriot 4430 or Titan XX30 Series with Phoenix 200 Antenna 7
 - Case IH Patriot 4430 or Titan XX30 Series without Phoenix 200 Antenna 5
- Preparing for Installation 3
 - Point of Reference 4
 - Recommendations 4
- Updates 4

K

Kit Contents 5

- Case IH Patriot 4430 or Titan XX30 Series with Phoenix 200 Antenna 7
- Case IH Patriot 4430 or Titan XX30 Series without Phoenix 200 Antenna 5

S

Startup Procedures

- Calibrating the SmarTrax System 23

RAVEN

Limited Warranty

What Does this Warranty Cover?

This warranty covers all defects in workmanship or materials in your Raven Applied Technology Division product under normal use, maintenance, and service when used for intended purpose.

How Long is the Coverage Period?

Raven Applied Technology products are covered by this warranty for 12 months from the date of retail sale. In no case will the Limited Warranty period exceed 24 months from the date the product was issued by Raven Industries Applied Technology Division. This warranty coverage applies only to the original owner and is non-transferable.

How Can I Get Service?

Bring the defective part and proof of purchase to your Raven dealer. If the dealer approves the warranty claim, the dealer will process the claim and send it to Raven Industries for final approval. The freight cost to Raven Industries will be the customer's responsibility. The Return Materials Authorization (RMA) number must appear on the box and all documentation (including proof of purchase) must be included inside the box to be sent to Raven Industries.

What Will Raven Industries Do?

Upon confirmation of the warranty claim, Raven Industries will (at our discretion) repair or replace the defective product and pay for the standard return freight, regardless of the inbound shipping method. Expedited freight is available at the customer's expense.

What is not Covered by this Warranty?

Raven Industries will not assume any expense or liability for repairs made outside our facilities without written consent. Raven Industries is not responsible for damage to any associated equipment or products and will not be liable for loss of profit, labor, or other damages. The obligation of this warranty is in lieu of all other warranties, expressed or implied, and no person or organization is authorized to assume any liability for Raven Industries.

Damages caused by normal wear and tear, misuse, abuse, neglect, accident, or improper installation and maintenance are not covered by this warranty.



Extended Warranty

What Does this Warranty Cover?

This warranty covers all defects in workmanship or materials in your Raven Applied Technology Division product under normal use, maintenance, and service when used for intended purpose.

Do I Need to Register My Product to Qualify for the Extended Warranty?

Yes. Products/systems must be registered within 30 days of retail sale to receive coverage under the Extended Warranty. If the component does not have a serial tag, the kit it came in must be registered instead.

Where Can I Register My Product for the Extended Warranty?

To register, go online to www.ravenhelp.com and select Product Registration.

How Long is the Extended Warranty Coverage Period?

Raven Applied Technology products that have been registered online are covered for an additional 12 months beyond the Limited Warranty for a total coverage period of 24 months from the date of retail sale. In no case will the Extended Warranty period exceed 36 months from the date the product was issued by Raven Industries Applied Technology Division. This Extended Warranty coverage applies only to the original owner and is non-transferable.

How Can I Get Service?

Bring the defective part and proof of purchase to your Raven dealer. If the dealer approves the warranty claim, the dealer will process the claim and send it to Raven Industries for final approval. The freight cost to Raven Industries will be the customer's responsibility. The Return Materials Authorization (RMA) number must appear on the box and all documentation (including proof of purchase) must be included inside the box to be sent to Raven Industries. In addition, the words "Extended Warranty" must appear on the box and all documentation if the failure is between 12 and 24 months from the retail sale.

What Will Raven Industries Do?

Upon confirmation of the product's registration for the Extended Warranty and the claim itself, Raven Industries will (at our discretion) repair or replace the defective product and pay for the standard return freight, regardless of the inbound shipping method. Expedited freight is available at the customer's expense.

What is Not Covered by the Extended Warranty?

Raven Industries will not assume any expense or liability for repairs made outside our facilities without written consent. Raven Industries is not responsible for damage to any associated equipment or products and will not be liable for loss of profit, labor, or other damages. Cables, hoses, software enhancements, and remanufactured items are not covered by this Extended Warranty. The obligation of this warranty is in lieu of all other warranties, expressed or implied, and no person or organization is authorized to assume any liability for Raven Industries.

Damages caused by normal wear and tear, misuse, abuse, neglect, accident, or improper installation and maintenance are not covered by this warranty.