

**Case IH Titan 4030 and 4530
Model Year 2012
SmartTrax™ Installation Manual**

P/N 016-4001-117 Rev B 06/15 E20577

Disclaimer

While every effort has been made to ensure the accuracy of this document, Raven Industries assumes no responsibility for omissions and errors. Nor is any liability assumed for damages resulting from the use of information contained herein.

Raven Industries shall not be responsible or liable for incidental or consequential damages or a loss of anticipated benefits or profits, work stoppage or loss, or impairment of data arising out of the use, or inability to use, this system or any of its components. Raven Industries shall not be held responsible for any modifications or repairs made outside our facilities, nor damages resulting from inadequate maintenance of this system.

As with all wireless and satellite signals, several factors may affect the availability and accuracy of wireless and satellite navigation and correction services (e.g. GPS, GNSS, SBAS, etc.). Therefore, Raven Industries cannot guarantee the accuracy, integrity, continuity, or availability of these services and cannot guarantee the ability to use Raven systems, or products used as components of systems, which rely upon the reception of these signals or availability of these services. Raven Industries accepts no responsibility for the use of any of these signals or services for other than the stated purpose.

Chapter 1	<i>Important Safety Information</i>	1
	Hydraulic Safety	2
	Electrical Safety	2
Chapter 2	<i>Introduction</i>	3
	Preparing for Installation	3
	Recommendations	4
	Point of Reference	4
	Updates	4
	Kit Contents	5
Chapter 3	<i>Hydraulic System Installation</i>	9
	Install Fittings in the SmarTrax Valve	10
	Mount the SmarTrax Valve	11
	Install the Left and Right Steering Hoses	12
	Install the Pressure and Tank Hoses	13
	Install the Load Sense Hoses	15
	Hydraulic Diagram	16
Chapter 4	<i>Cab Component Installation</i>	17
	Disassemble the Instructional Seat	17
	Install the SmarTrax Node	18
	Mount the SmarTrax Node	19
	Node Mounting Locations	20
	Install the Foot Switch	21
	Install the Node Harness	21
	Install the Valve Harness	24
	System Diagrams	27
Chapter 5	<i>Startup Procedures</i>	29
	Verify the SmarTrax System Installation	29
	Calibrate the SmarTrax System	30

CHAPTER

1

Important Safety Information

NOTICE

Read this manual and the operation and safety instructions included with your implement and/or controller carefully before installing the SmarTrax™ system.

- Follow all safety information presented within this manual.
- If you require assistance with any portion of the installation or service of your Raven equipment, contact your local Raven dealer for support.
- Follow all safety labels affixed to the SmarTrax system components. Be sure to keep safety labels in good condition and replace any missing or damaged labels. To obtain replacements for missing or damaged safety labels, contact your local Raven dealer.

When operating the machine after installing SmarTrax, observe the following safety measures:

- Be alert and aware of surroundings.
- Do not operate SmarTrax or any agricultural equipment while under the influence of alcohol or an illegal substance.
- Remain in the operator's position in the machine at all times when SmarTrax is engaged.
- Disable SmarTrax when exiting the operator's seat and machine.
- Do not drive the machine with SmarTrax enabled on any public road.
- Determine and remain a safe working distance from other individuals. The operator is responsible for disabling SmarTrax when the safe working distance has diminished.
- Ensure SmarTrax is disabled prior to starting any maintenance work on SmarTrax or the machine.



WARNING

- When starting the machine for the first time after installing SmarTrax, be sure that all persons stand clear in case a hose has not been properly tightened.
- The machine must remain stationary and switched off during SmarTrax installation or maintenance.

 **CAUTION**

Hydraulic Safety

- Raven Industries recommends that appropriate protective equipment be worn at all times when working on the hydraulic system.
- Never attempt to open or work on a hydraulic system with the equipment running. Care should always be taken when opening a system that has been previously pressurized.
- When disconnecting the hydraulic hoses or purging is required, be aware that the hydraulic fluid may be extremely hot and under high pressure. Caution must be exercised.
- Any work performed on the hydraulic system must be done in accordance with the machine manufacturer's approved maintenance instructions.
- When installing SmarTrax hydraulics or performing diagnostics, maintenance, or routine service, ensure that precautions are taken to prevent any foreign material or contaminants from being introduced into the machine's hydraulic system. Objects or materials that are able to bypass the machine's hydraulic filtration system will reduce performance and possibly damage the SmarTrax valve.

Electrical Safety

- Always verify that the power leads are connected to the correct polarity as marked. Reversing the power leads could cause severe damage to the equipment.
- Ensure that the power cable is the last cable to be connected.

CHAPTER

2

Introduction

Congratulations on your purchase of the Steering Ready system! This system is designed to provide cutting-edge, hands-free steering of the machine via Global Positioning System (GPS) coordinates.

This manual applies to the following machines:

MAKE: Case IH
MODEL: Titan 4030 and 4530
YEAR: 2012

FIGURE 1. Case IH Titan 4530



Preparing for Installation

Before installing the SmarTrax system, park the machine where the ground is level, clean, and dry. Turn off the machine and leave it turned off for the duration of the installation process. Bleed pressure from the hydraulic system by loosening the hydraulic fittings slowly, where applicable.

During the installation process, follow good safety practices. Be sure to carefully read the instructions in this manual as you complete the installation process.

Recommendations

Raven Industries recommends the following best practices when installing or operating the SmarTrax system for the first time, at the start of the season, or when moving the SmarTrax system to another machine:

- Install the GPS antenna in the recommended location. Refer to the following table for the machine-specific antenna mounting location.

Note: *If your machine is not listed, install the antenna on the front-center of the cab.*

Machine Preset	Antenna X Position (left to right)	Antenna Y Position (from the rear wheel axle to the antenna position on the cab)	Antenna Z Position (ground to top of antenna)
Case IH FLX 40x0/45x0	Centered	15 ft./4.57 m	11.8 ft./3.61 m

- Ensure the machine's hydraulic filters have been recently changed and there are no issues with the machine's hydraulic system (e.g., pump issues, faulty hydraulic motors, fine metal deposits in the hydraulic hoses, etc.).
- Ensure the machine's hydraulic system is using fresh oil and debris is flushed from the hydraulic hoses, valves, and filters.

Raven Industries recommends the following best practices when installing the SmarTrax system:

- Use part numbers to identify the parts.
- Do not remove the plastic wrap from a part until it is necessary for installation.
- Do not remove plastic caps from a part until it is necessary for installation.

Point of Reference

The instructions in this manual assume that you are standing behind the machine, looking toward the cab.

Updates

Software and manual updates are available on the Raven Applied Technology website:

<http://www.ravenhelp.com>

At Raven Industries, we strive to make your experience with our products as rewarding as possible. One way to improve this experience is to provide us with feedback on this manual.

Your feedback will help shape the future of our product documentation and the overall service we provide. We appreciate the opportunity to see ourselves as our customers see us and are eager to gather ideas on how we have been helping or how we can do better.

To serve you best, please send an email with the following information to

techwriting@ravenind.com

- Case IH Titan 4030 and 4530, Model Year 2012 SmarTrax™ Installation Manual
- Manual No. 016-4001-117 Rev. B
- Any comments or feedback (include chapter or page numbers if applicable).
- Let us know how long have you been using this or other Raven products.

We will not share your email or any information you provide with anyone else. Your feedback is valued and extremely important to us.

Thank you for your time.

2

Kit Contents

This section contains a list of the components that are included in the SmarTrax kit. Before beginning the SmarTrax installation, compare the items in the kit with the components on this list. If you have questions about the kit, contact your Raven dealer.

TABLE 1. SmarTrax Installation Kit (P/N 117-4001-117)



Picture	Item Description	Part Number	Qty.
Not Pictured	Manual - SmarTrax and SmartSteer Calibration & Operation	016-0171-277	1
Not Pictured	Manual - Case IH Titan 4030 and 4530 Series, Model Year 2012 SmarTrax Installation	016-4001-117	1
	Valve - SmarTrax Hydraulic	063-0131-129	1
	Bracket - Hydraulic Valve Mounting	107-0171-907	1

TABLE 1. SmarTrax Installation Kit (P/N 117-4001-117)





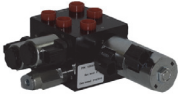





Picture	Item Description	Part Number	Qty.
	Bracket - Node Mounting	107-0172-084	1
	Assembly - SmarTrax Enable Switch	063-0172-470	1
	Cable - SmarTrax Valve Harness	115-4001-002	1
	Cable - SmarTrax Node Harness	115-4001-138	1
	Transducer - 0-3000 PSI Pressure	422-0000-086	1
	Bolt - 5/16"-18 x 7/8" Hex	311-0052-104	4
	Bolt - 3/8"-16 x 1" Hex	311-0054-105	2
	Nut - 3/8"-16	312-1001-037	2
	Nut - 3/5"-16 Flanged Lock	312-1001-164	3
	Nut - M6 Lock	312-4000-207	4
	Washer - 1/4" Split Lock	313-1000-016	4

TABLE 1. SmarTrax Installation Kit (P/N 117-4001-117)







Picture	Item Description	Part Number	Qty.
	Washer - 5/16" Split Lock	313-1000-019	4
	Washer - 3/8" Split Lock	313-1000-022	2
	Washer - 0.250" ID x 0.562" OD Flat	313-2300-009	4
	Washer - 3/8" Flat	313-2300-013	2

TABLE 2. Hydraulic Installation Kit (P/N 117-0199-023)

Picture	Item Description	Part Number	Qty.
	Fitting - 8 ORFS M/M/F Swivel Run Tee Adapter	333-0012-028	4
	Fitting - 6 ORFS M/F 90° Swivel Elbow	333-0012-065	2
	Fitting - 8 ORFS M/F 90° Swivel Elbow	333-0012-067	4
	Fitting - 6 ORFS (M) to -6 SAE O-Ring (M) Straight Adapter	333-0012-084	4
	Fitting - 4 ORFS (M) TO -6 SAE O-Ring (M) Straight Adapter	333-0012-195	2
	Hydraulic Hose - 4 ORFS (F) to -4 ORFS (F) 90° - 26"	214-1000-316	1

TABLE 2. Hydraulic Installation Kit (P/N 117-0199-023)

Picture	Item Description	Part Number	Qty.
	Hydraulic Hose - -8 ORFS (F) 90° to -6 ORFS (F) - 25"	214-1000-663	2
	Hydraulic Hose - -8 ORFS (F) 90° to -6 ORFS (F) - 15"	214-1000-664	2

CHAPTER

3

***Hydraulic System
Installation***



! WARNING

Hydraulics are under pressure. Care should always be taken with a system that has been pressurized.

Before beginning the SmarTrax hydraulic installation, turn off the machine and relieve pressure by turning the steering wheel left and right.

Never work on a hot machine. Always allow it to cool before performing diagnostics, maintenance, or routine service.

When disconnecting or purging hydraulic hoses, be aware that the hydraulic fluid within the machine's system may be extremely hot and under high pressure.

Tampering with hydraulic valves may cause serious injury or death, and will void the warranty.



! CAUTION

When installing SmarTrax hydraulics or performing diagnostics, maintenance, or routine service, ensure precautions are taken to prevent any foreign material from being introduced into the machine's hydraulic system.

Objects or materials that are able to bypass the machine's hydraulic filtration system will reduce performance and possibly damage the SmarTrax hydraulic valve.

	<h3 style="margin: 0;">NOTICE</h3>
<p>The appearance of the SmarTrax hydraulic valve may vary slightly from the images contained in this manual. However, the fittings, hose connections, and cable connections remain the same.</p>	

Install Fittings in the SmarTrax Valve

Before mounting the SmarTrax valve (P/N 063-0131-129) on the machine, install the proper fittings in the valve. This prepares the valve for installation and simplifies the hose connection process later in the procedure.

FIGURE 1. Fittings Installed in the SmarTrax Valve

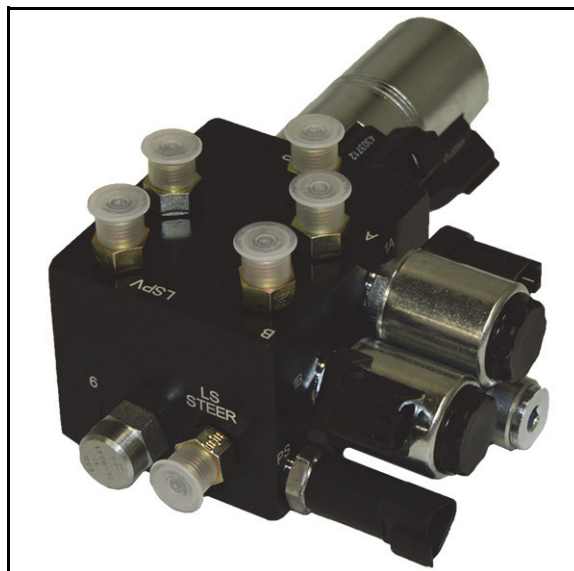

Fitting	Part Number	Port
Fitting - -6 ORFS (M) to -6 SAE O-Ring (M) Straight Adapter	333-0012-084	A, B P, T
Fitting - -4 ORFS (M) to -6 SAE O-Ring (M) Straight Adapter	333-0012-195	LSPV, LS STEER
Transducer - 0-3000 PSI Pressure	422-0000-086	PS

Mount the SmarTrax Valve

FIGURE 2. SmarTrax Valve Mounting Location



1. Identify the valve mounting location under the hood, just in front of the steering orbital.
2. Secure the SmarTrax valve (P/N 063-0131-129) to the hydraulic valve mounting bracket (P/N 107-0171-907) using four 5/16"-18 x 7/8" hex bolts (P/N 311-0052-104) and four 5/16"-18 lock washers (P/N 313-1000-019).

FIGURE 3. SmarTrax Valve Mounted to the Machine

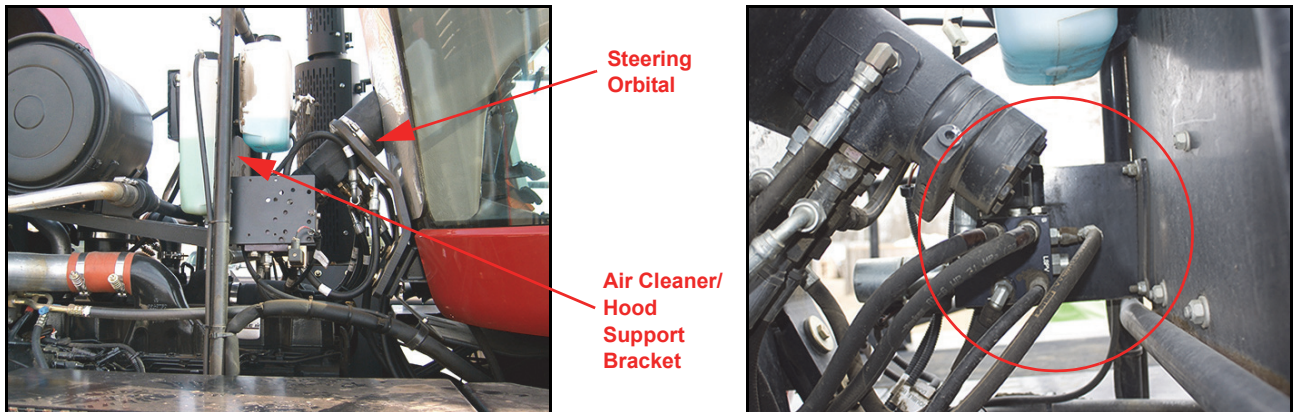

3. Mount the valve mounting bracket to the air cleaner/hood support bracket using two 3/8"-16 x 1" hex bolts (P/N 311-0054-105), two 3/8" flat washers (P/N 313-2300-013), two 3/8" lock washers (P/N 313-1000-022) and two 3/8"-16 nuts (P/N 312-1001-037).

Note: It may be necessary to drill additional holes to install the mounting bracket.

Install the Left and Right Steering Hoses

FIGURE 4. Left Steering Hose Installed

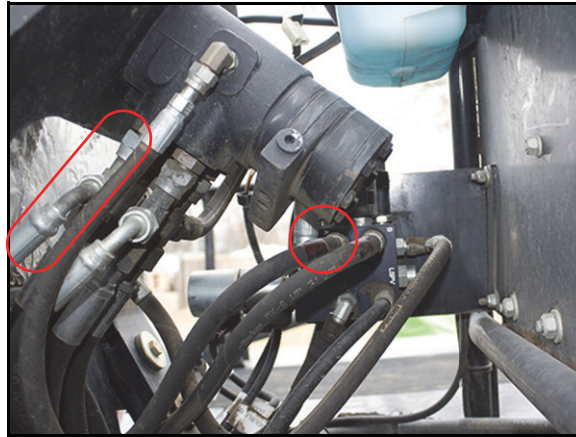

1. Disconnect the machine's left steering hose from the steering orbital.
2. Install a -8 ORFS M/M/F swivel run tee adapter fitting (P/N 333-0012-028) in the open port of the steering orbital.
3. Connect the machine's left steering hose to the opposite end of the installed tee fitting.
4. Install the 90° end of the supplied hydraulic hose (P/N 214-1000-663) on the 90° end of the installed tee fitting.

Note: It may be necessary to install a -8 ORFS M/F 90° swivel elbow fitting (P/N 333-0012-067) on the tee fitting to achieve the connection.

5. Connect the straight end of the installed hydraulic hose to the fitting installed in Port A of the SmarTrax valve.

Note: It may be necessary to install a -6 ORFS M/F 90° swivel elbow fitting (P/N 333-0012-065) on the fitting installed in Port A of the SmarTrax valve to achieve the connection.

FIGURE 5. Right Steering Hose Installed

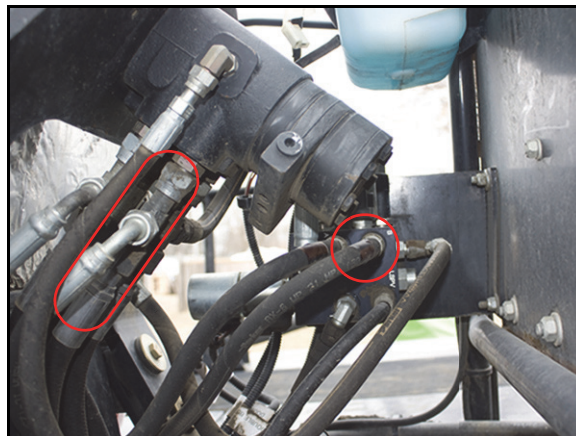

6. Disconnect the machine's right steering hose from the steering orbital.
7. Install a -8 ORFS M/M/F swivel run tee adapter fitting (P/N 333-0012-028) in the open port of the steering orbital.

8. Connect the machine's right steering hose to the opposite end of the installed tee fitting.
9. Install the 90° end of the supplied hydraulic hose (P/N 214-1000-663) on the 90° end of the installed tee fitting.

Note: It may be necessary to install a -8 ORFS M/F 90° swivel elbow fitting (P/N 333-0012-067) on the tee fitting to achieve the connection.

10. Connect the straight end of the installed hydraulic hose to the fitting installed in Port B of the SmarTrax valve.

Note: It may be necessary to install a -6 ORFS M/F 90° swivel elbow fitting (P/N 333-0012-065) on the fitting installed in Port B of the SmarTrax valve to achieve the connection.

Install the Pressure and Tank Hoses

FIGURE 6. Pressure Hose Installed

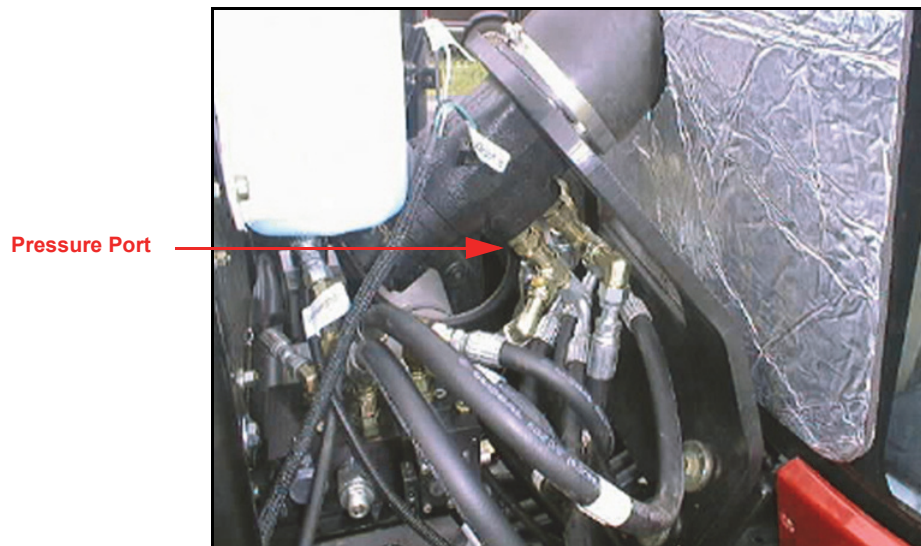

1. Disconnect the machine's pressure hose from the steering orbital.
2. Install a -8 ORFS M/M/F swivel run tee adapter fitting (P/N 333-0012-028) in the open port of the steering orbital.
3. Connect the machine's pressure hose to the opposite end of the installed tee fitting.
4. Install the 90° end of the supplied hydraulic hose (P/N 214-1000-664) on the 90° end of the installed tee fitting.

Note: It may be necessary to install a -8 ORFS M/F 90° swivel elbow fitting (P/N 333-0012-067) on the tee fitting to achieve the connection.

5. Connect the straight end of the installed hydraulic hose to the fitting installed in Port P of the SmarTrax valve.

Note: It may be necessary to install a -6 ORFS M/F 90° swivel elbow fitting (P/N 333-0012-065) on the fitting installed in Port P of the SmarTrax valve to achieve the connection.

FIGURE 7. Tank Hose Installed

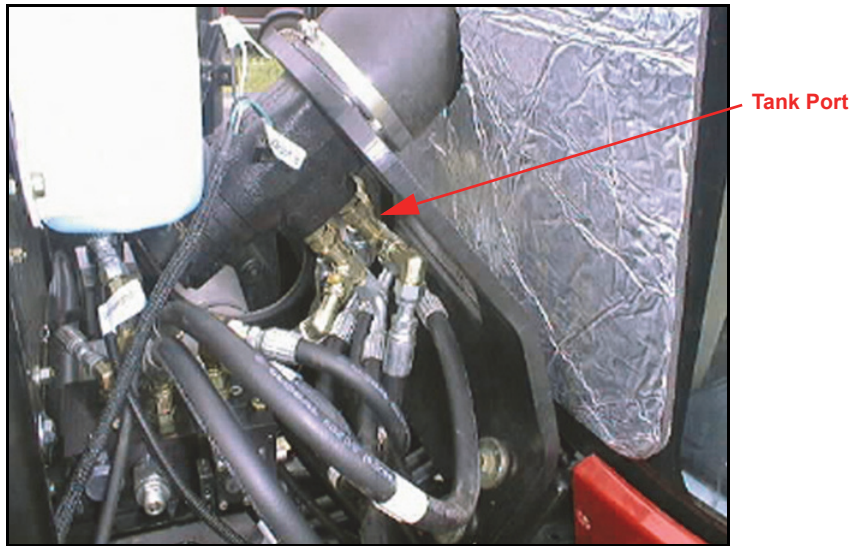

6. Disconnect the machine's tank hose from the steering orbital.
7. Install a -8 ORFS M/M/F swivel run tee adapter fitting (P/N 333-0012-028) in the open port of the steering orbital.
8. Connect the machine's tank hose to the opposite end of the installed tee fitting.
9. Install the 90° end of the supplied hydraulic hose (P/N 214-1000-664) on the 90° end of the installed tee fitting.

Note: *It may be necessary to install a -8 ORFS M/F 90° swivel elbow fitting (P/N 333-0012-067) on the tee fitting to achieve the connection.*

10. Connect the straight end of the installed hydraulic hose to the fitting installed in Port T of the SmarTrax valve.

Note: *It may be necessary to install a -6 ORFS M/F 90° swivel elbow fitting (P/N 333-0012-065) on the fitting installed in Port T of the SmarTrax valve to achieve the connection.*

Install the Load Sense Hoses

FIGURE 8. Load Sense Port on the Steering Orbital

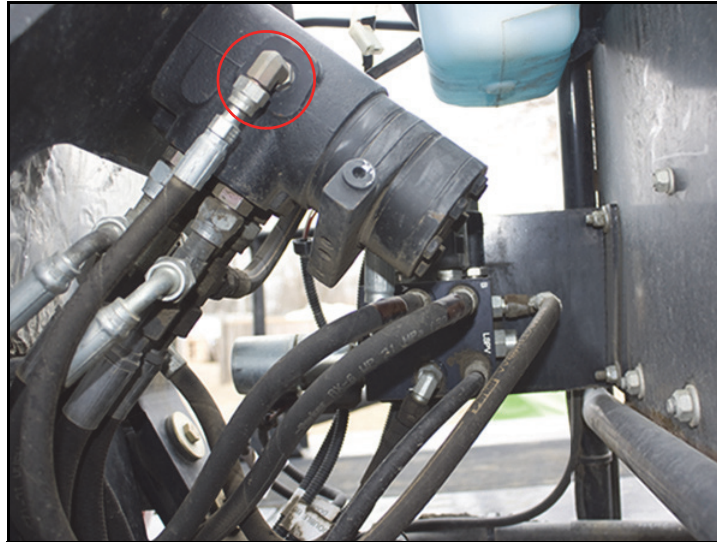

1. Disconnect the machine's load sense hose from the steering orbital.

FIGURE 9. SmarTrax Valve Load Sense Hose Connections

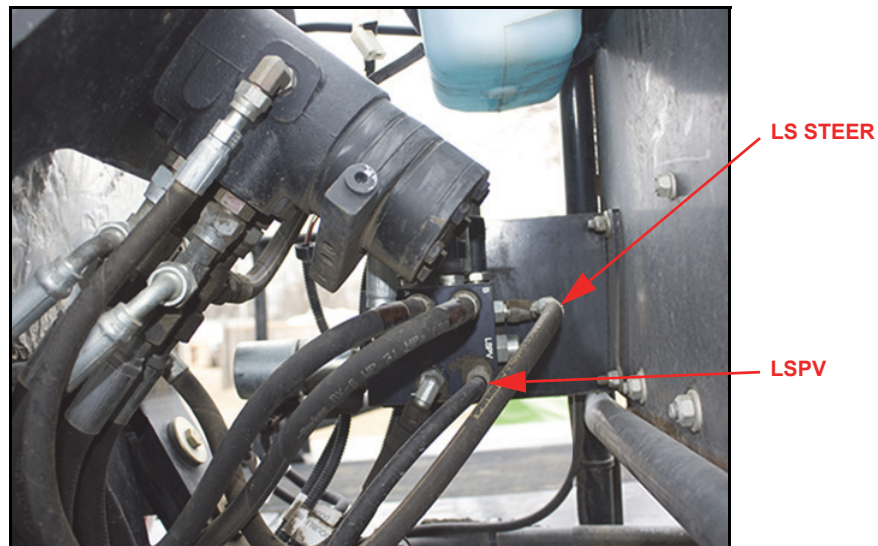

2. Connect the machine's load sense hose to the fitting installed in Port LSPV on the SmarTrax valve.
3. Install the straight end of the supplied hydraulic hose (P/N 214-1000-316) on the open port of the steering orbital.
4. Connect the 90° end of the installed hydraulic hose to the fitting installed in Port LS STEER of the SmarTrax valve.

Hydraulic Diagram

Before SmarTrax Installation

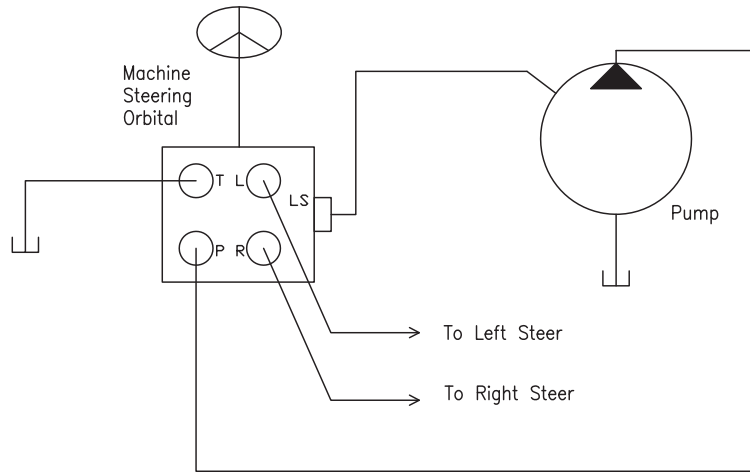

After SmarTrax Installation

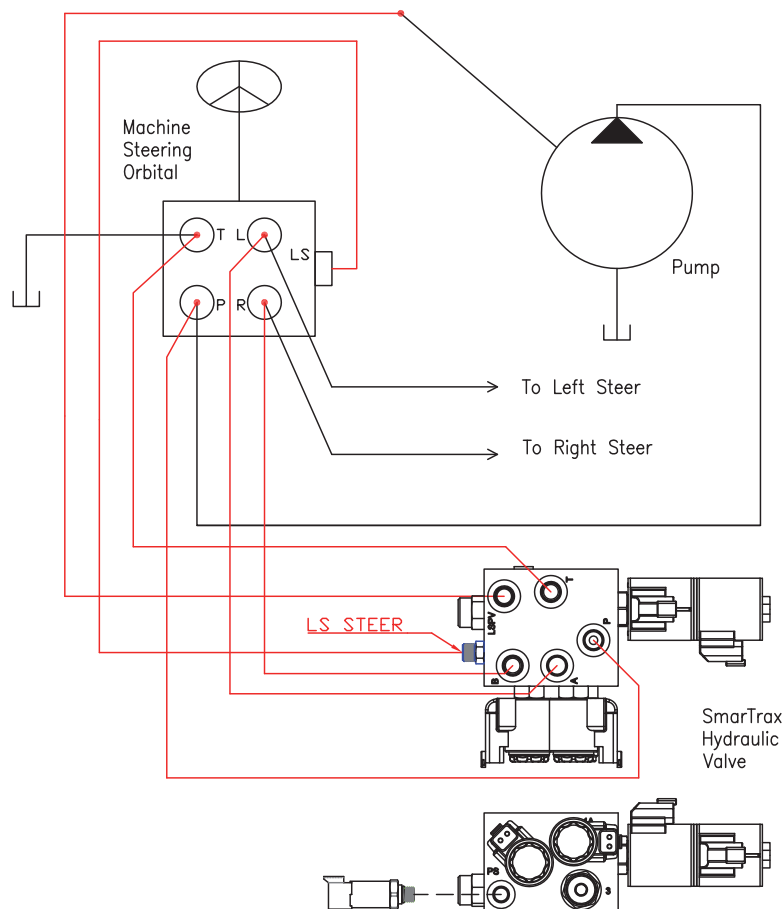

CHAPTER

4

***Cab Component
Installation***

Disassemble the Instructional Seat

FIGURE 1. Instructional Seat Mounting Screws



1. Uninstall the instructional seat cushion by removing the screws that secure it to the frame.
2. Remove any contents from under the instructional seat.

FIGURE 2. Floor Mat Removed from Cab



3. Lift the floor mat from the floor in front of the seat.

FIGURE 3. Removing Instructional Seat Molding



4. Remove the plastic molding under the instructional seat by removing the nuts and bolts that secure it.

Install the SmarTrax Node

Note: The SmarTrax node (P/N 063-0173-228) is sold separately. Contact your local Raven dealer for ordering information.

Mount the SmarTrax Node

FIGURE 4. Node Mounted to Mounting Plate



1. Mount the SmarTrax node (P/N 063-0173-228) to the node mounting plate (P/N 063-0172-084) using three 3/8"-16 zinc flanged lock nuts (P/N 312-1001-164).
2. Place the node in the instructional seat compartment so the connectors face the door.

FIGURE 5. Node Mounted to Cab Floor

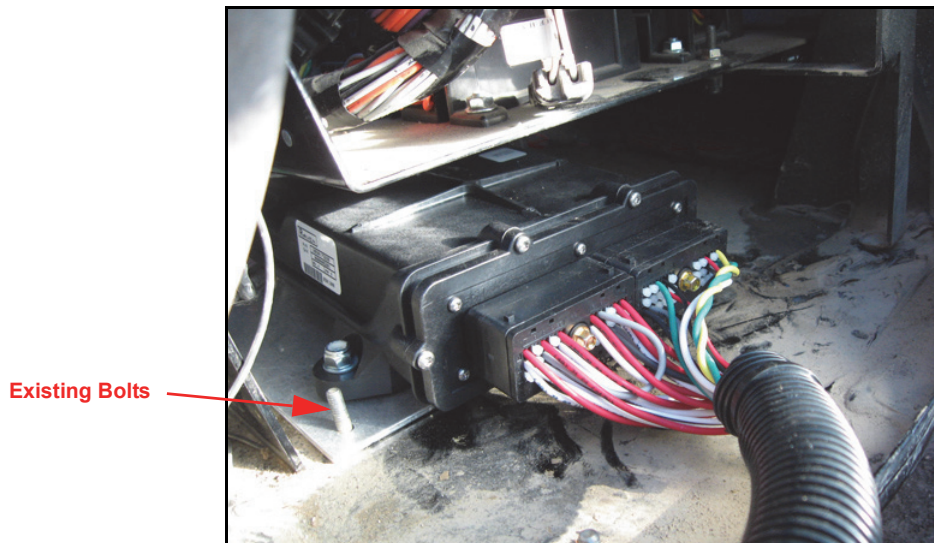

3. Secure the node mounting plate to the existing bolts in the floor of the cab using four 1/4" zinc split lock washers (P/N 313-1000-016), four washers (P/N 313-2300-009), and four M6 lock nuts (P/N 312-4000-207).

Node Mounting Locations

FIGURE 6. Node Mounting

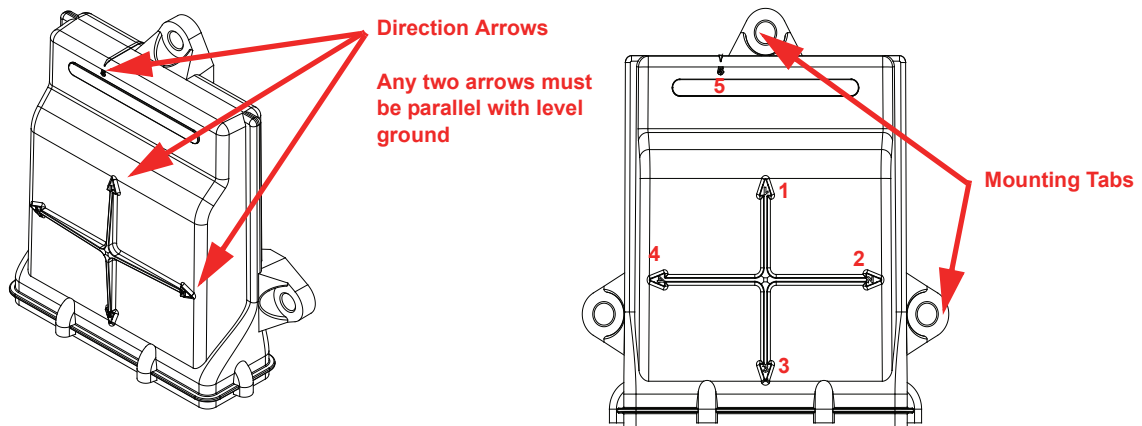

When choosing the location for the SmarTrax node, consider the following points:

- Mount the SmarTrax node inside the machine's cab on a flat, level surface for proper performance and cable connection.
- One of the six numbered direction arrows on the node must be oriented in the direction of forward vehicle travel, one arrow pointing straight up, and two of the arrows parallel to the ground.

Note: *Make a note of the number of the arrow that is oriented in the direction of forward vehicle travel. This number will be needed during the SmarTrax calibration process.*

- The node mounting location must not create tripping hazards.
- Mount the node in a location where it will not be kicked or jarred during normal equipment operation.
- The location must allow cable routing to avoid crimping or damaging the cables or the node connections.
- Securely fasten the node using bolts or screws through at least two of the three mounting holes. When mounted properly, the node should not become loose or rotate.

Install the Foot Switch

FIGURE 7. Foot Switch Installed



1. Select a suitable location for the foot switch (P/N 063-0172-470) to be installed.

Note: The foot switch should be installed in a location where the operator has easy access to it and is able to fully press the pedal.

2. Using the holes in the foot switch as a template, drill holes in the floor of the cab.
3. Secure the foot switch to the floor by installing the supplied screws in each of the mounting holes.
4. Route the cable connector behind the operator's seat.

Install the Node Harness

FIGURE 8. Node Cable Installed on Node

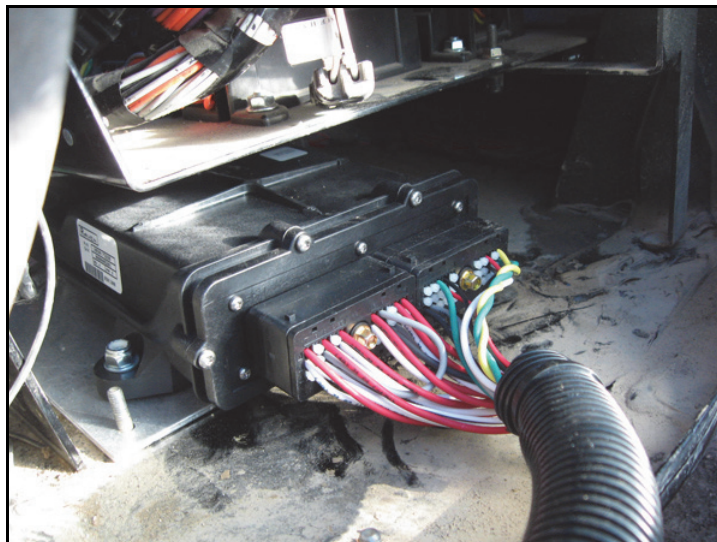

1. Install the two large, rectangular connectors of the node harness (P/N 115-4001-138) into the correct ports of the node, tightening the bolts on the harness connectors to secure the connections.

Note: *The connectors should be facing the window.*

2. Locate the ENABLE connector and connect it to the foot switch cable connector behind the operator's seat.
3. Route the node harness into the fuse box.

FIGURE 9. CAN Connector Installed on Machine's CAN System

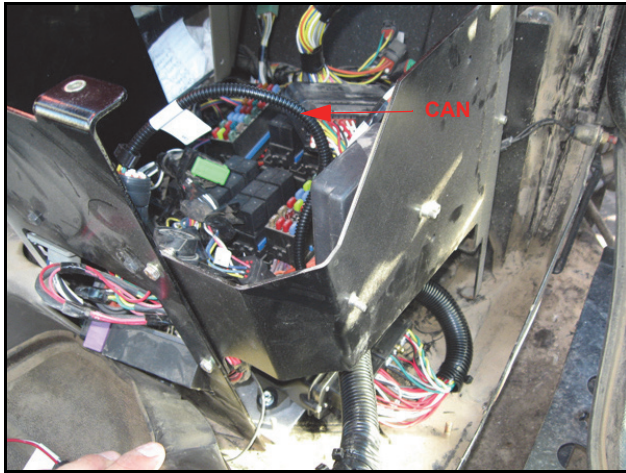

4. Connect the CAN connector to the machine's existing CAN system.

FIGURE 10. DGPS OUT Connector Routed Under Operator's Seat



5. Route the DGPS OUT connector out the right corner of the operator's seat base and under the right arm rest.

FIGURE 11. DGPS OUT Connected to Console Receiver Connection

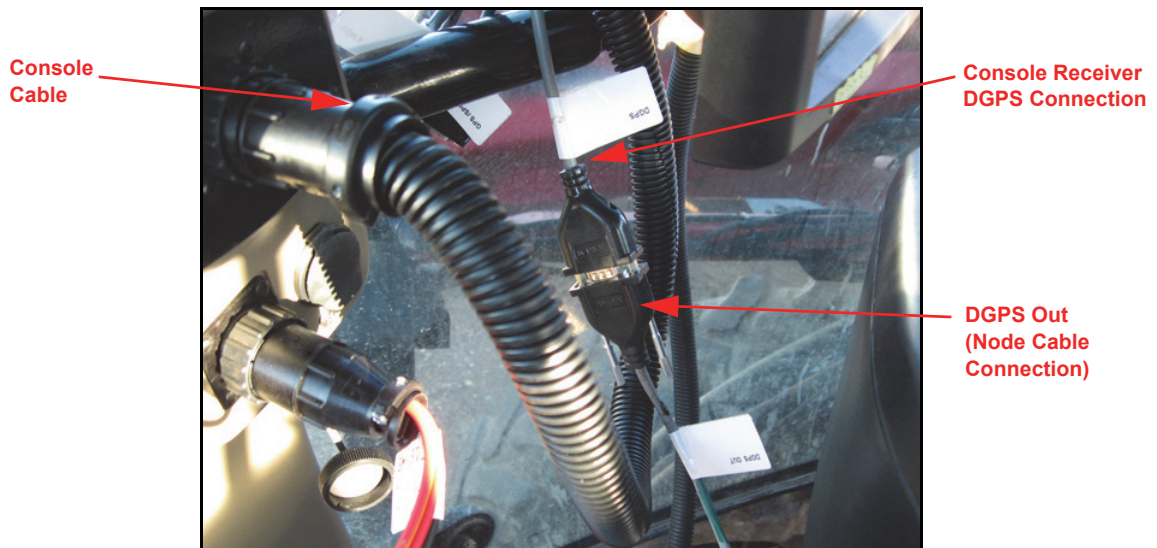

- Route and connect the DGPS OUT connector to the console's DGPS connector.

FIGURE 12. 3-Pin Power Connection



- Connect the round 3-pin power connector of the node cable into the convenience power port on the instructional seat.

Note: *High current power, which is used to run the steering operations, should be connected to a power source separate from logic power, which is used to facilitate processing and communication between the node and the console.*



Install the Valve Harness

FIGURE 13. Valve Cable Routed Through Access Point



1. Route the valve harness (P/N 115-4001-002) into the cab from the foam access point under the convenience tray to the right of the seat.
2. Remove the vent plate behind the operator's seat.

FIGURE 14. Valve Harness Connected to Node Harness



3. Connect the rectangular 12-pin connector on the valve harness into the mating connection of the node harness (P/N 115-4001-138).
4. Connect the PSI connector to the transducer (P/N 422-0000-086) installed in Port PS of the SmarTrax valve (P/N 063-0131-139).

FIGURE 15. LEFT and RIGHT Harness Connection Ports

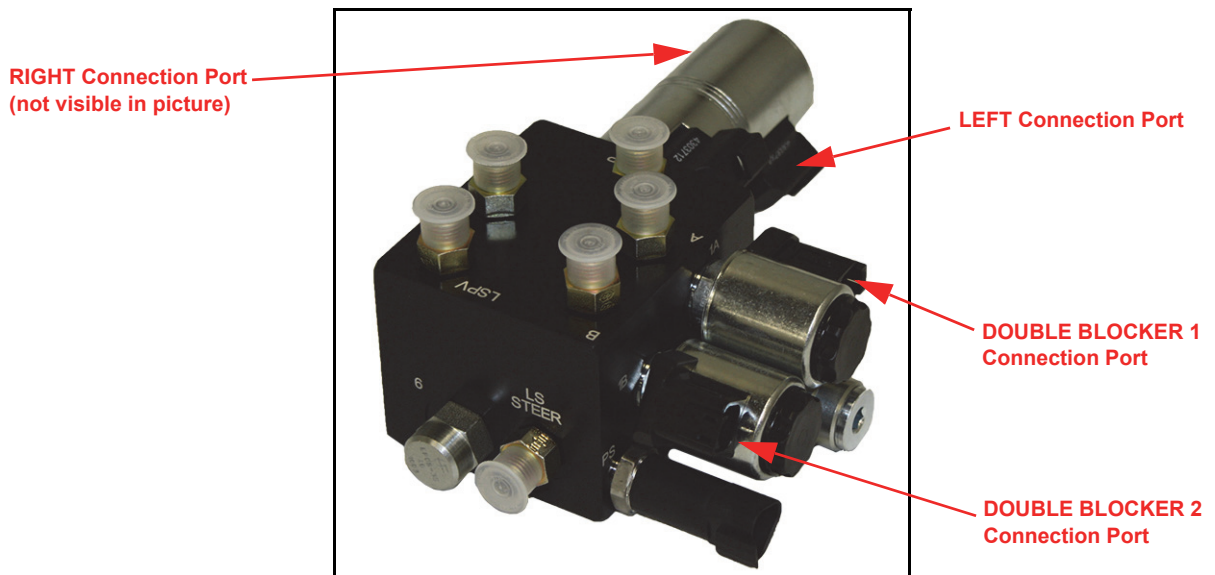

5. Connect the DOUBLE BLOCKER 1 connector to Port 1A of the SmarTrax valve.
6. Connect the DOUBLE BLOCKER 2 connector to Port 1B of the SmarTrax valve.
7. Connect the LEFT connector to the bottom coil of the stack on the SmarTrax valve.
8. Connect the RIGHT connector to the top coil of the stack on the SmarTrax valve.

FIGURE 16. Valve Harness Wiring Diagram

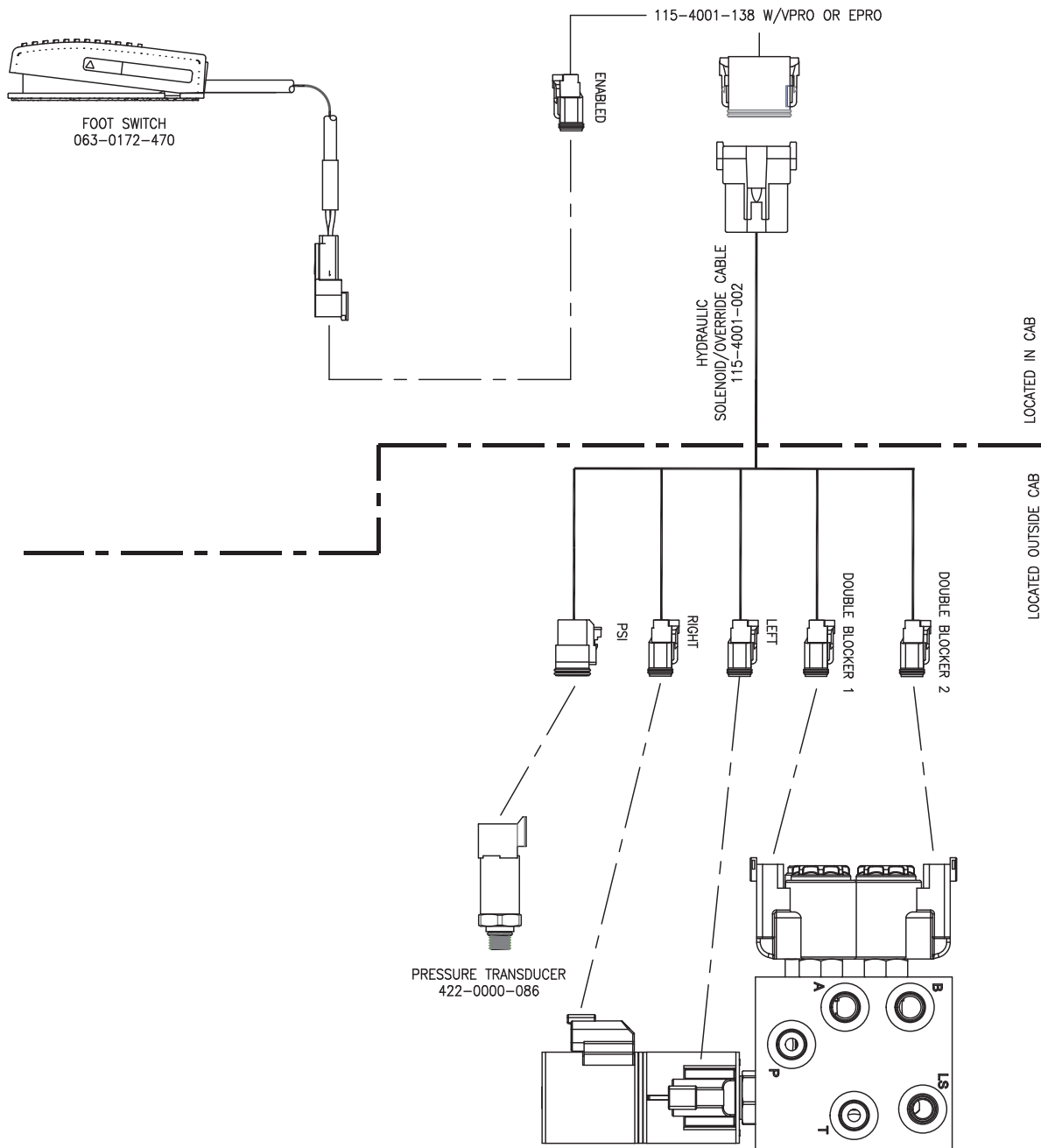

System Diagrams

CAN NODE WIRING

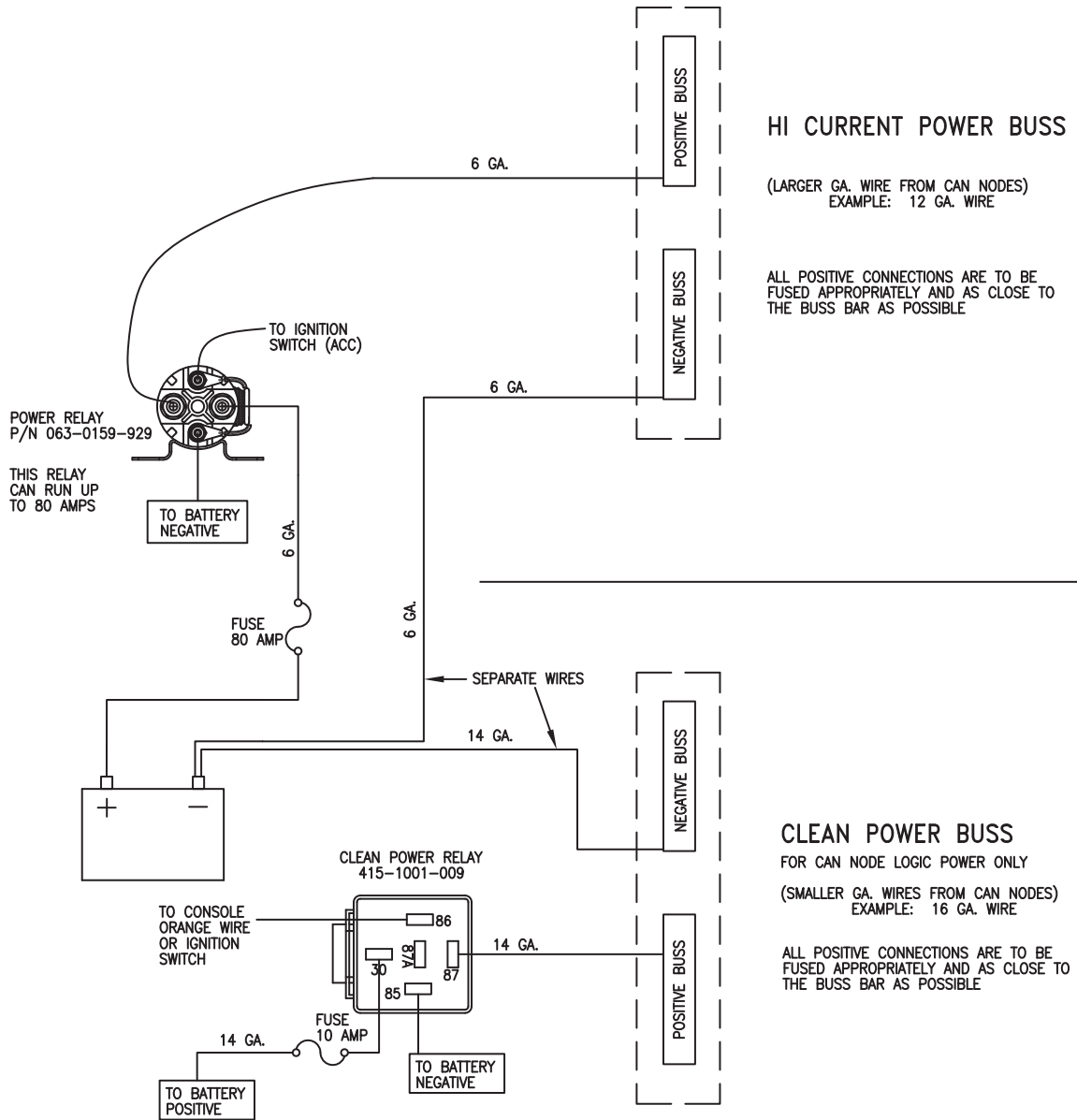

ENVIZIO PRO/VIPER PRO/SMARTRAX 3D/CASE TITAN 30 SERIES

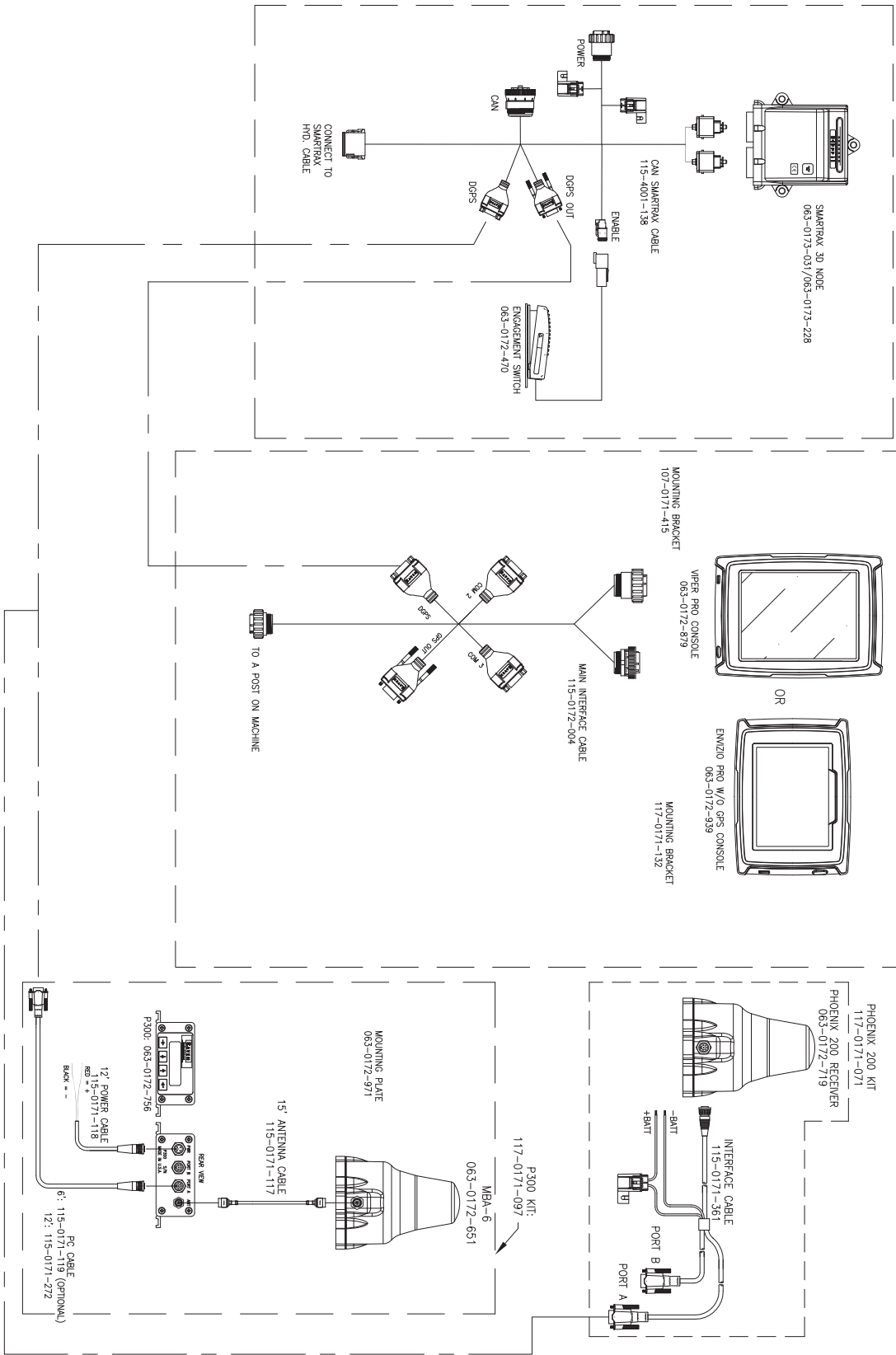

CHAPTER

5

Startup Procedures



WARNING

When starting the machine for the first time after installing SmarTrax, be sure that all persons stand clear in case a hose has not been properly tightened.



WARNING

Do not use hands to check for leaks. Hydraulic fluid under pressure can penetrate the skin and cause serious injury or death.

Verify the SmarTrax System Installation

1. Turn on the machine.
2. Double-check all fittings and hose connections to ensure that:
 - Hoses are not rubbing on or interfering with moving parts.
 - Hydraulic fluid is not leaking from the system.
3. Turn the machine's wheels fully from side to side repeatedly to remove air from the hydraulic system.

Note: *During the SmarTrax system installation, whenever the hydraulic system is purged for maintenance, or when fittings are loosened or disconnected, air is introduced into the lines of the hydraulic system. If air pockets are present, the wheels may not move consistently when the steering wheel is turned.*

4. Continue turning the wheels until they move steadily and smoothly when the steering wheel is turned.

5. Access the System Diagnostic screen by selecting the MACHINE TEST option on the Machine Type screen and turn the wheels using the Raven console.

Note: *If there are issues with the SmarTrax system, turn off the machine and correct them immediately. For additional assistance, refer to the SmarTrax and SmartSteer Calibration & Operation Manual (P/N 016-0171-277) or contact your local Raven dealer.*

Calibrate the SmarTrax System

Refer to the SmarTrax and SmartSteer Calibration and Operation Manual (P/N 016-0171-277) for instructions on calibrating the SmarTrax system, adjusting system settings, and system operation.

C**Cab Component Installation**

- Disassembling the Instructional Seat 17
- Installing the Foot Switch 21
- Installing the Node Harness 21
- Installing the SmarTrax Node 18
 - Mounting the SmarTrax Node 19
 - Node Mounting Locations 20
- Installing the Valve Harness 24

H**Hydraulic Installation**

- Hydraulic Diagram 16
- Installing Fittings in the SmarTrax Valve 10
- Installing the Left and Right Steering Hoses 12
- Installing the Load Sense Hoses 15
- Installing the Pressure and Tank Hoses 13
- Mounting the SmarTrax Valve 11

I**Important Safety Information**

- Electrical Safety 2
- Hydraulic Safety 2

Introduction

- Kit Contents 5
- Preparing for Installation 3
 - Point of Reference 4
 - Recommendations 4

K**Kit Contents 5****S****Startup Procedures**

- Calibrating the SmarTrax System 30
- Verifying the SmarTrax System Installation 29

RAVEN

Limited Warranty

What Does this Warranty Cover?

This warranty covers all defects in workmanship or materials in your Raven Applied Technology Division product under normal use, maintenance, and service when used for intended purpose.

How Long is the Coverage Period?

Raven Applied Technology products are covered by this warranty for 12 months from the date of retail sale. In no case will the Limited Warranty period exceed 24 months from the date the product was issued by Raven Industries Applied Technology Division. This warranty coverage applies only to the original owner and is non-transferable.

How Can I Get Service?

Bring the defective part and proof of purchase to your Raven dealer. If the dealer approves the warranty claim, the dealer will process the claim and send it to Raven Industries for final approval. The freight cost to Raven Industries will be the customer's responsibility. The Return Materials Authorization (RMA) number must appear on the box and all documentation (including proof of purchase) must be included inside the box to be sent to Raven Industries.

What Will Raven Industries Do?

Upon confirmation of the warranty claim, Raven Industries will (at our discretion) repair or replace the defective product and pay for the standard return freight, regardless of the inbound shipping method. Expedited freight is available at the customer's expense.

What is not Covered by this Warranty?

Raven Industries will not assume any expense or liability for repairs made outside our facilities without written consent. Raven Industries is not responsible for damage to any associated equipment or products and will not be liable for loss of profit, labor, or other damages. The obligation of this warranty is in lieu of all other warranties, expressed or implied, and no person or organization is authorized to assume any liability for Raven Industries.

Damages caused by normal wear and tear, misuse, abuse, neglect, accident, or improper installation and maintenance are not covered by this warranty.



Extended Warranty

What Does this Warranty Cover?

This warranty covers all defects in workmanship or materials in your Raven Applied Technology Division product under normal use, maintenance, and service when used for intended purpose.

Do I Need to Register My Product to Qualify for the Extended Warranty?

Yes. Products/systems must be registered within 30 days of retail sale to receive coverage under the Extended Warranty. If the component does not have a serial tag, the kit it came in must be registered instead.

Where Can I Register My Product for the Extended Warranty?

To register, go online to www.ravenhelp.com and select Product Registration.

How Long is the Extended Warranty Coverage Period?

Raven Applied Technology products that have been registered online are covered for an additional 12 months beyond the Limited Warranty for a total coverage period of 24 months from the date of retail sale. In no case will the Extended Warranty period exceed 36 months from the date the product was issued by Raven Industries Applied Technology Division. This Extended Warranty coverage applies only to the original owner and is non-transferable.

How Can I Get Service?

Bring the defective part and proof of purchase to your Raven dealer. If the dealer approves the warranty claim, the dealer will process the claim and send it to Raven Industries for final approval. The freight cost to Raven Industries will be the customer's responsibility. The Return Materials Authorization (RMA) number must appear on the box and all documentation (including proof of purchase) must be included inside the box to be sent to Raven Industries. In addition, the words "Extended Warranty" must appear on the box and all documentation if the failure is between 12 and 24 months from the retail sale.

What Will Raven Industries Do?

Upon confirmation of the product's registration for the Extended Warranty and the claim itself, Raven Industries will (at our discretion) repair or replace the defective product and pay for the standard return freight, regardless of the inbound shipping method. Expedited freight is available at the customer's expense.

What is Not Covered by the Extended Warranty?

Raven Industries will not assume any expense or liability for repairs made outside our facilities without written consent. Raven Industries is not responsible for damage to any associated equipment or products and will not be liable for loss of profit, labor, or other damages. Cables, hoses, software enhancements, and remanufactured items are not covered by this Extended Warranty. The obligation of this warranty is in lieu of all other warranties, expressed or implied, and no person or organization is authorized to assume any liability for Raven Industries.

Damages caused by normal wear and tear, misuse, abuse, neglect, accident, or improper installation and maintenance are not covered by this warranty.