

RAVEN

Simply improving your position.SM

SmarTrax™ Installation Manual



CaseIH 91xx, 92xx, and 93xx Series

Disclaimer

While every effort has been made to ensure the accuracy of this document, Raven Industries assumes no responsibility for omissions and errors. Nor is any liability assumed for damages resulting from the use of information contained herein.

Raven Industries shall not be held responsible or liable for the effects of atmospheric conditions and sunspot activity on the performance of our products.

Raven Industries cannot guarantee the accuracy, integrity, continuity, or availability of the GPS signal from the U.S. Department of Defense/NAVSTAR GPS satellites, the OmniSTAR correction service or the WAAS correction service.

Raven Industries accepts no responsibility for the use of the signal for other than the stated purpose. Raven Industries shall not be responsible or liable for incidental or consequential damages or a loss of anticipated benefits or profits, work stoppage or loss or impairment of data arising out of the use, or inability to use, the SmarTrax or any of its components.

Chapter 1	<i>Important Safety Information</i>	1
	Important Safety Information	1
Chapter 2	<i>Introduction</i>	3
	Updates	4
	Preparing for Installation	4
	Hydraulic Fittings	5
	Kit Contents	5
Chapter 3	<i>Mounting the SmarTrax Hydraulic Valve</i>	9
	Mount the SmarTrax Hydraulic Valve	9
	Affixing the SmarTrax Tampering Warning Label	10
Chapter 4	<i>Hydraulic Connections</i>	11
	Install the Left and Right Steer Hose	12
	Install the Pressure Hose	13
	Install the Tank Hose	14
	Install the LS-Steer and LS-PV Hoses	15
	Install the Pressure Switch	15
	Hydraulic Connection Diagram	16
Chapter 5	<i>Start-Up Procedures</i>	17
	Remove Air from the Hydraulic System	17
	Verify the SmarTrax Installation	18
Chapter 6	<i>Wiring and Electrical Connections</i>	19
	Connecting the SmarTrax Hydraulic Valve	19
	Connecting the Pressure Override Switch	20
	Route the Console Cable Harness	20
	Install the Foot Switch	21
	Mount the SmarTrax Controller	21
	Install the Yaw Sensor	22
	Install the SmarTrax Node	23
Chapter 7	<i>System Drawings</i>	25

CHAPTER

1

Important Safety Information

Important Safety Information

NOTICE

Read this manual and the operation and safety instructions included with your implement and/or controller carefully before installing the SmarTrax™ system.

- Follow all safety information presented within this manual
- If you require assistance with any portion of the installation or service of your Raven equipment, contact your local Raven dealer for support.
- Follow all safety labels affixed to the SmarTrax components. Be sure to keep safety labels in condition and replace any missing or damaged labels. To obtain replacements for missing or damaged safety labels, contact your local Raven dealer.

When operating the machine after installing SmarTrax, observe the following safety measures:

- Be alert and aware of surroundings.
- Do not operate SmarTrax or any agricultural equipment while under the influence of alcohol or an illegal substance.
- Remain in the operator's position in the machine at all times when SmarTrax is engaged.
- Disable SmarTrax when exiting from the operator's seat and machine.
- Do not drive the machine with SmarTrax enabled on any public thorough-fare or main road.
- Determine and remain a safe working distance from other individuals. The operator is responsible for disabling SmarTrax when the safe working distance has diminished.
- Ensure SmarTrax is disabled prior to starting any maintenance work on SmarTrax or the machine.

Please review the operation and safety instructions included with your implement and/or controller.

WARNING

- Always wear appropriate protective equipment when working on hydraulics.
- This machine must remain stationary and switched off with the booms unfolded and supported while installation or maintenance is conducted.
- Before starting the hydraulic installation, be sure to bleed pressure from the hydraulic system.
- Hydraulic fluid may be hot or under high pressure. When starting the machine for the first time after installing the SmarTrax system, be sure that all persons stand clear of the machine in case a hose or fitting has not been completely tightened.

CAUTION

Hydraulic Safety

- Raven Industries recommends that appropriate protective equipment be worn at all times when working on the hydraulic system.
- Never attempt to open or work on a hydraulic system with the equipment running. Care should always be taken when first opening a system that has previously been pressurized.
- When disconnecting the hydraulic hoses or purging is required, be aware that the hydraulic oil may be extremely hot and under high pressure. Caution must be exercised.
- Any work carried out on the hydraulic system must be performed in accordance with the machine manufacturer's approved maintenance instructions.
- When installing SmarTrax hydraulics or performing diagnostics, maintenance, or routine service, ensure precautions are taken to prevent any foreign material or contaminants from being introduced in the machine's hydraulic system. Objects or materials that are able to bypass the machine's hydraulic filtration system will adversely reduce performance and possibly damage the SmarTrax hydraulic valves.

Electrical Safety

- Always verify that the power leads are connected to the correct polarity as marked. Reversing the power leads could cause severe damage to the equipment.
- Ensure that the power cable is the last cable to be connected.

CHAPTER

2

Introduction

Congratulations on your purchase of the Raven SmarTrax system. This system is designed to provide cutting-edge, hands-free steering of agricultural equipment via GPS (Global Positioning System) coordinates.

This manual applies to the following machines. For future reference, write your serial number in the space below.

Make: CaseIH 91xx, 92xx, 93xx

Year:

Serial Number:

FIGURE 1. CaseIH 9370



Updates

Updates for Raven manuals as well as software updates for Raven consoles are available at the Applied Technology Division web site:

<http://www.ravenprecision.com/Support/index2.jsp>

Sign up for e-mail alerts and we will notify you when updates for your Raven products are available on the Raven web site.

<http://www.ravenprecision.com>

Preparing for Installation

Before installing SmarTrax, park the machine where the ground is level, clean, and dry. Be sure to follow proper safety practices and procedures during the SmarTrax installation procedure. Bleed pressure from the hydraulic system and leave the machine turned off for the duration of the installation process. Carefully read and follow the instructions in this manual to properly complete the installation process.

Recommendations

Observe the following recommendations while installing the SmarTrax system:

- Use part numbers to identify parts.
- Do not remove the plastic wrapping from a part until it is necessary for installation.
- Do not remove plastic caps from a part until it is necessary for installation.

Tools Needed

Before beginning the installation process, it is a good idea to gather all the tools that you will need. These tools include the following items:

- Screwdrivers of various sizes
- SAE Standard-sized wrenches
- Allen wrenches
- Utility knife
- Drill
- Drill bits
- Side Cutters
- Pliers

Point of Reference

The instructions in this manual assume that you are standing behind the machine, looking toward the cab.

Hydraulic Fittings

The following fitting types may be referenced in this manual:

FIGURE 2. Hydraulic Fitting Types

JIC Fitting (M)



SAE O-Ring Fitting (M)



ORFS Fitting (M)



Kit Contents

This section contains a list of the kit contents that you should have received with this SmarTrax kit. Before you begin assembling the kit, compare the items in your SmarTrax kit with this list. If you have questions about your kit, contact your local Raven dealer or the Raven Customer Support Center.

In addition to the following kits, a SmarTrax Controller or Node kit is required to complete installation of the SmarTrax system. Contact your local Raven dealer for available kits and ordering information.

TABLE 1. CaseIH 91xx, 92xx, 93xx SmarTrax Installation Kit (P/N 117-0195-043)





Picture	Item Description	Part Number	Qty
Not pictures	Manual - SmarTrax Installation	016-0190-043	1
	Sensor - Yaw	063-0172-684	1
	Cable - SmarTrax Console Harness	115-0171-775	1
	Plate - Hydraulic Valve Mounting	107-0171-578	1
	Bracket - Hydraulic Valve Mounting	116-0159-527	1

TABLE 1. CaseIH 91xx, 92xx, 93xx SmarTrax Installation Kit (P/N 117-0195-043)









Picture	Item Description	Part Number	Qty
	Switch - SmarTrax Pressure	422-0000-073	1
	Valve - SmarTrax Hydraulic	334-0003-066	1
	Label - Tampering Warning	041-0159-689	1
	Bolt - 5/16" Hex Head	311-0052-104	4
	Bolt - 3/8" Hex Head	311-0054-105	4
	Nut - 3/8" Hex	312-1001-037	4
	Washer - 3/8" Split Lock	313-1000-022	4
	Washer - 3/8" Flat	313-2300-013	4
	Washer - 5/16" Split Lock	313-1000-019	4

TABLE 2. CaseIH 91xx, 92xx, 93xx SmarTrax Hydraulic Kit (P/N 117-0194-043)

Picture	Item Description	Part Number	Qty
	Fitting - 9/16" JIC (M/F) 45° Swivel Elbow	333-0012-027	4
	Fitting - 7/16" JIC (M/M) Straight Adapter	333-0012-041	1
	Fitting - 9/16" JIC (M/F) 90° Swivel Elbow	333-0012-042	2
	Fitting - 1 1/16 (F) to 3/4" JIC (M) Reducer	333-0012-063	2
	Fitting - 3/4" JIC (M/F) 90° Swivel Elbow	333-0012-064	2
	Fitting - 7/8" JIC (M/F) 90° Swivel Elbow	333-0012-108	2
	Fitting - 1 1/16" JIC (M/M/F) Swivel Run Tee	333-0012-109	2
	Fitting - 7/8" JIC (M/M/F) Swivel Run Tee	333-0012-113	2
	Hose - 7/16" JIC (F) to 9/16" JIC (F), 36"	214-1000-191	1
	Hose - 7/16" JIC (F) to 9/16" JIC (F), 24"	214-1000-192	1



TABLE 2. CaseIH 91xx, 92xx, 93xx SmarTrax Hydraulic Kit (P/N 117-0194-043)

Picture	Item Description	Part Number	Qty
	Hose - 3/4" JIC (F) to 9/16" JIC (F), 36"	214-1000-195	2
	Hose - 7/8" JIC (F) to 9/16" JIC (F), 36"	214-1000-193	2

CHAPTER

3

Mounting the SmarTrax Hydraulic Valve

Mount the SmarTrax Hydraulic Valve

The mounting location of the bracket is on a brace that is attached to the air cleaner tube between the steering orbitrol and the engine on the left side of the machine.

FIGURE 1. Valve Mounting Location



Valve Mounting Location

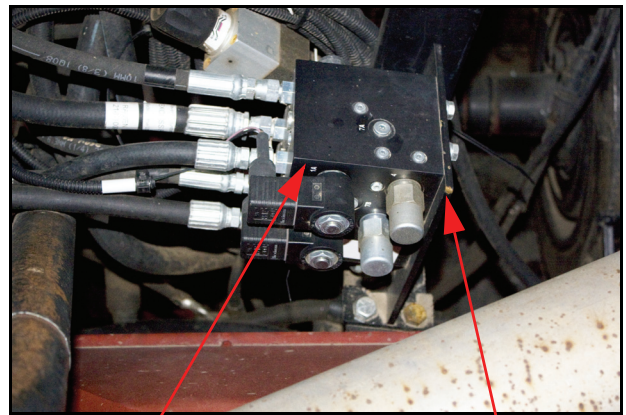

SmarTrax Valve
(P/N 334-0003-066)

SmarTrax
mounting bracket
(P/N 016-0159-527)

1. Mount the valve mounting bracket (P/N 116-0159-527) to the machine using the supplied bolts (P/N 311-0054-105), flat washers (P/N 313-2300-013), lock washers (P/N 313-1000-022), split washers (P/N 333-1000-022) and nuts (P/N 312-1001-037).

Note: Depending on the year and model of the tractor, you may also need to use the supplied mounting plate (P/N 116-0159-578).

2. Mount the SmarTrax hydraulic valve (P/N 334-0003-066) to the mounting bracket using the supplied bolts (P/N 311-0052-104) and lock washers (P/N 313-1000-019).

Affixing the SmarTrax Tampering Warning Label

Raven Industries supplies a tampering warning label (P/N 041-0159-689) with all SmarTrax kits. This label should be applied on or near the SmarTrax hydraulic valve or mounting bracket and in a location where anyone working on the machine is able to clearly see and read the label.

1. Thoroughly clean and dry the surface to which the label will be affixed.
2. Remove the protective backing from the tampering warning label (P/N 041-0159-689).
3. Carefully apply the label to the cleaned area and rub with a dry cloth to ensure the label is firmly applied.

CHAPTER

4

***Hydraulic
Connections***



⚠ WARNING

Hydraulics may be under pressure. Never attempt to open or work on a hydraulic system with the equipment running. Care should always be taken when working on a system that has previously been pressurized. When disconnecting or purging hydraulic connections, be aware that hydraulic oil within the system may be extremely hot and under high pressure.



⚠ CAUTION

Ensure precautions are taken to prevent any foreign material or contaminants from being introduced into the machine's hydraulic system. Objects or materials that are able to bypass the machine's hydraulic filtration system will adversely reduce performance and possibly damage the SmarTrax hydraulic valves.



⚠ CAUTION

Before beginning the SmarTrax hydraulic installation procedure, turn off the machine and relieve hydraulic pressure by turning the wheel left and right.

Install the Left and Right Steer Hose

1. Disconnect the existing left steer hose from the port on the steering orbitrol.
2. Install the supplied run tee fitting (P/N 333-0012-113) and reconnect the original left steer hose to the fitting.
3. Install a supplied 90° fitting (P/N 333-0012-108) to the remaining 90° portion of the tee fitting.
4. Connect the supplied hose (P/N 214-1000-193) to the tee fitting.

FIGURE 1. Left and Right Steering Connections

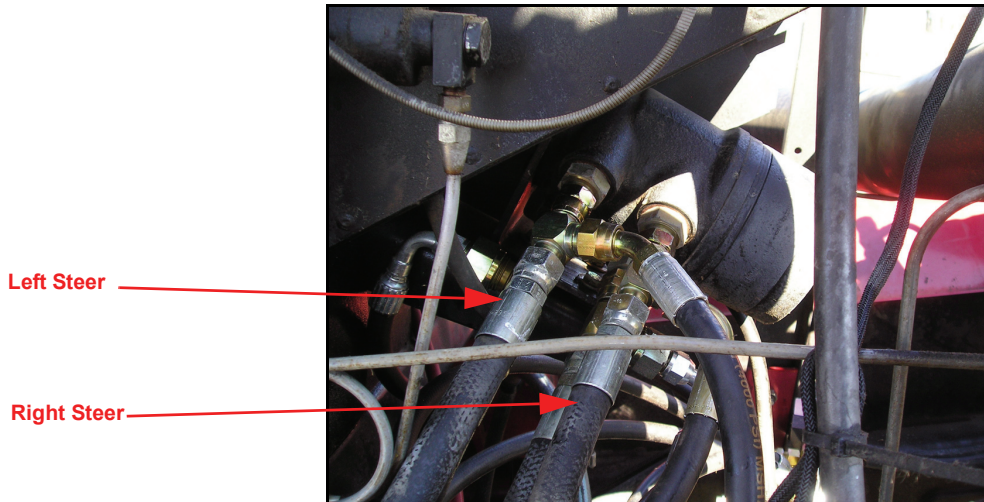

5. Route the other end of the hose to Port 'A' of the SmarTrax hydraulic valve using a supplied 45° fitting (P/N 333-0012-027) or a supplied 90° fitting (P/N 333-0012-042).
6. Repeat the procedure for the right steer line and connect the other supplied hose (P/N 214-1000-193) to Port 'B' on the SmarTrax hydraulic valve.

FIGURE 2. Left and Right Steer Hose Connected to SmarTrax Hydraulic Valve

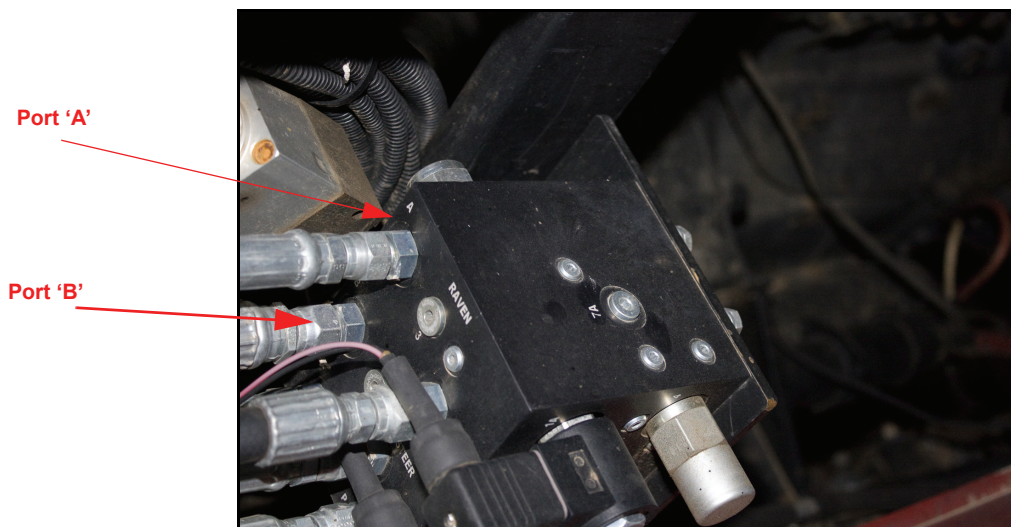

Install the Pressure Hose

1. Disconnect the existing pressure hose from the steering orbitrol.
2. Install the supplied run tee fitting (P/N 333-0012-109) and reconnect the original pressure hose to the straight portion of the fitting.
3. Install a supplied reducer fitting (P/N 333-0012-063) and a 90° fitting (P/N 333-0012-064) to the remaining 90° portion of the tee fitting.
4. Connect the supplied hose (P/N 214-1000-195) to the tee fitting.

FIGURE 3. Machine's Steering Orbitrol

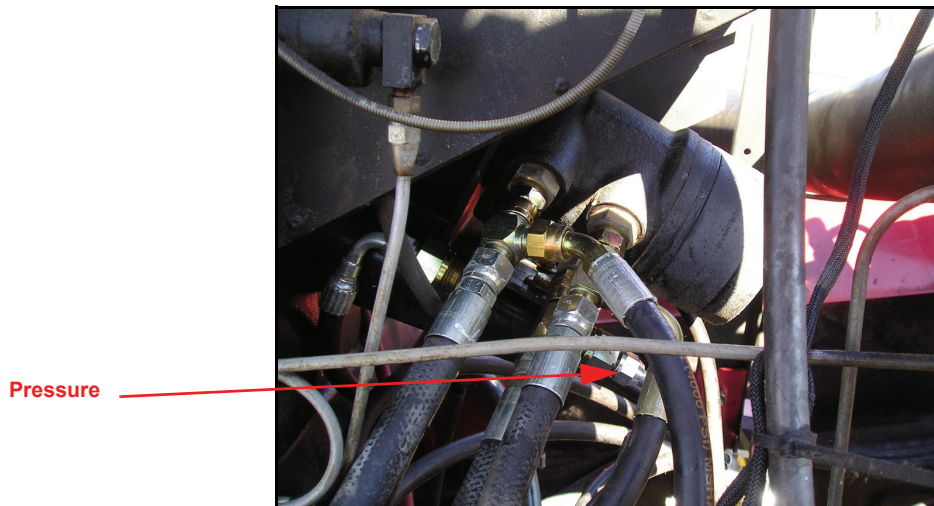

5. Route the other end of the hose to Port 'P' of the SmarTrax hydraulic valve using a supplied 45° fitting (P/N 333-0012-027) or a supplied 90° fitting (P/N 333-0012-042).

FIGURE 4. Pressure Hose Connected to SmarTrax Hydraulic Valve

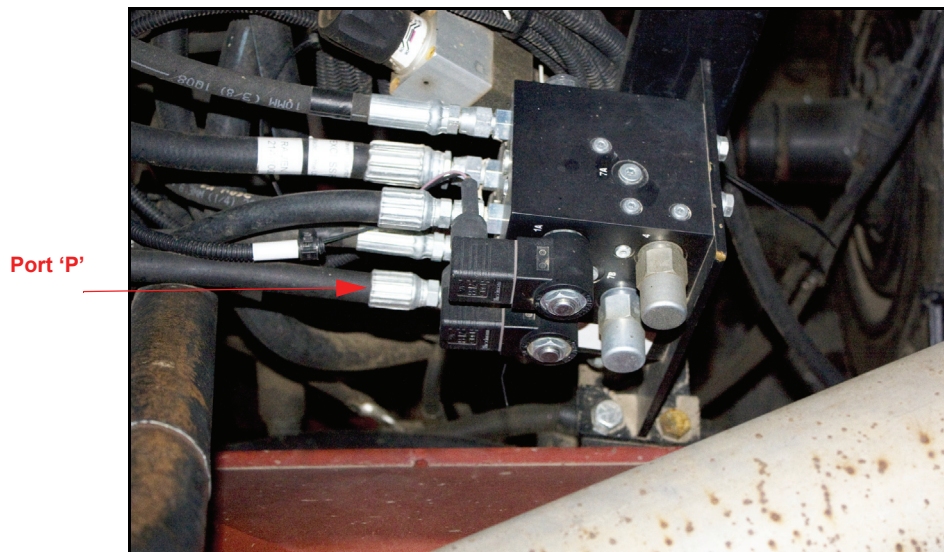

Install the Tank Hose

1. Disconnect the existing tank hose from the steering orbitrol.
2. Install the supplied run tee fitting (P/N 333-0012-109) and reconnect the original tank hose to the straight portion of the fitting.
3. Install a supplied reducer fitting (P/N 333-0012-063) and 90° fitting (P/N 333-0012-064) to the remaining 90° portion of the tee fitting.
4. Connect the supplied hose (P/N 214-1000-195) to the fitting.

FIGURE 5. Machine's Steering Orbitrol

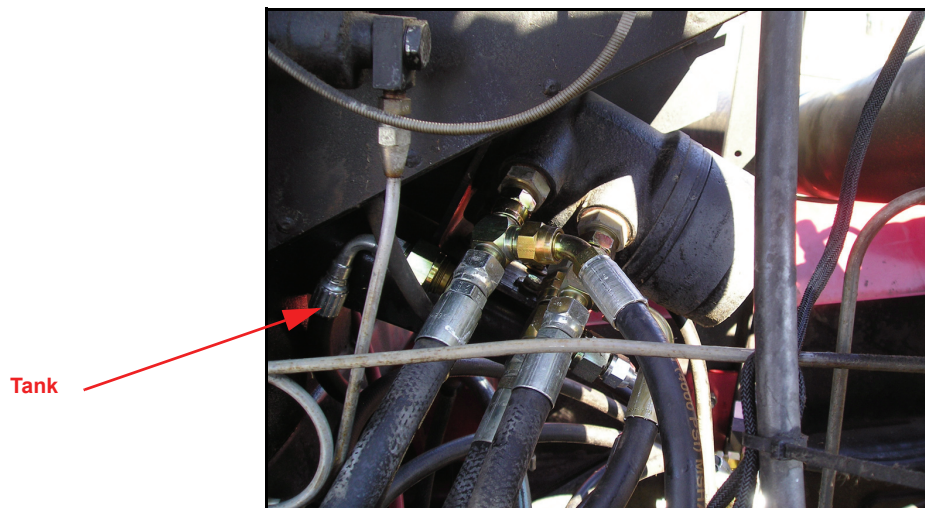

5. Route the other end of the hose to Port 'T' of the SmarTrax hydraulic valve using a supplied 45° fitting (P/N 333-0012-027) or a supplied 90° fitting (P/N 333-0012-042).

FIGURE 6. Tank Hose Connected to SmarTrax Hydraulic Valve

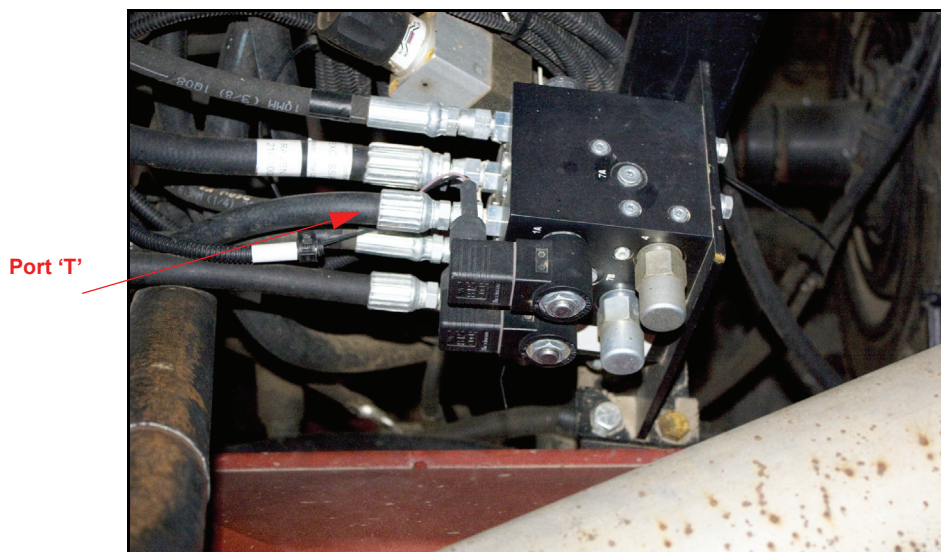

Install the LS-Steer and LS-PV Hoses

1. Begin by disconnecting the original load sense hose from the steering orbitrol.
2. Install the supplied fitting (P/N 333-0012-041) to the end of the hose that was just removed from the steering orbitrol.
3. Connect the supplied hose (P/N 214-1000-192) to the fitting.
4. Route the other end of the hose to the 'LS-PV' Port on the SmarTrax hydraulic valve.
5. Connect the supplied hose (P/N 214-1001-191) to the 'LS-Steer' Port on the SmarTrax hydraulic valve.
6. Route the hose to the load sense port on the steering orbitrol.

FIGURE 7. LS-Steer Hose Connected to SmarTrax Hydraulic Valve

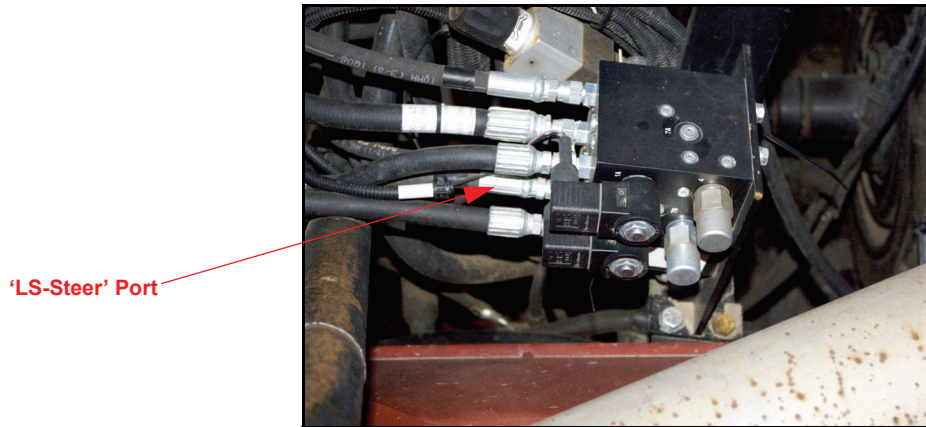

Install the Pressure Switch

Install the pressure switch directly to the 'PS' Port on the SmarTrax hydraulic valve.

Hydraulic Connection Diagram

Before Smartrax Installation

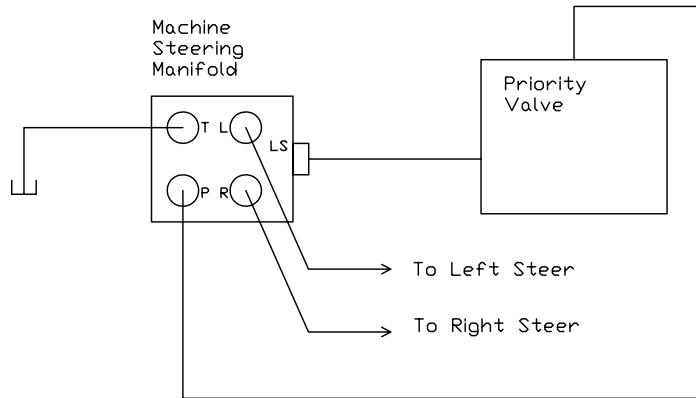

After Smartrax Installation

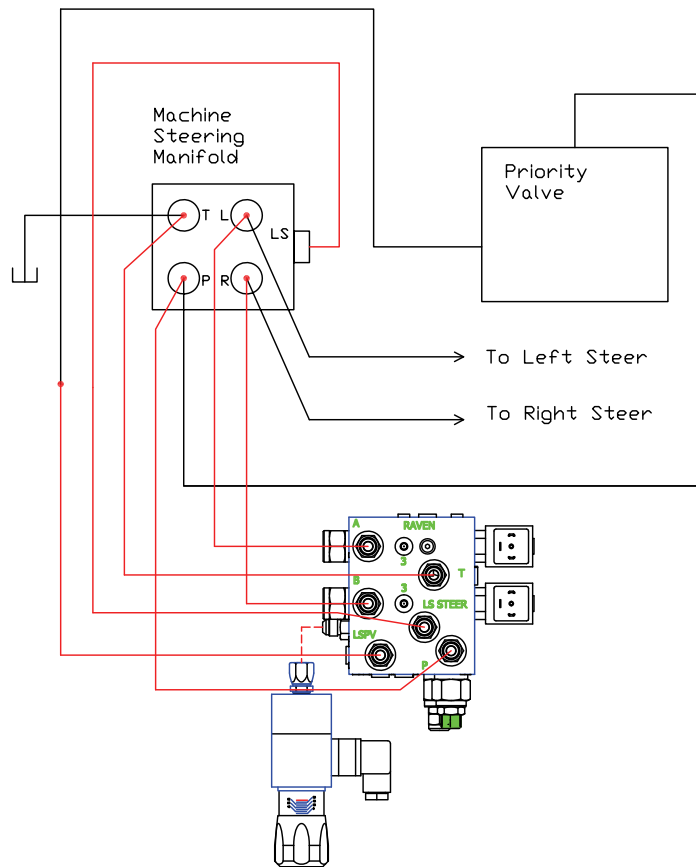

CHAPTER

5

Start-Up Procedures



! WARNING

When starting the machine for the first time, keep the area around the machine clear of people or bystanders in case a fitting or hose has not been fully tightened.



! WARNING

DO NOT use hands to check for leaks. Hydraulic fluid under pressure can penetrate the skin and cause serious injury or death.

Always wear appropriate protective equipment when working with the hydraulic system.

Remove Air from the Hydraulic System

Anytime a hydraulic system is purged for maintenance, or during the SmarTrax system installation, air is introduced into the hydraulic lines. Anytime the system is purged or fittings are loosened or disconnected, it is important to remove air pockets from the hydraulic system to avoid unwanted operation of the hydraulic system.

To remove air from the hydraulic system, turn the wheels fully from side to side repeatedly. If air pockets are present, the wheels may not move consistently while the steering wheel is operated. Continue turning the wheels until the wheels move steadily and smoothly with the steering wheel.

Verify the SmarTrax Installation

1. Turn on the machine.
2. With the machine running, double-check all fitting and hose connections to ensure that:
 - Hoses are not rubbing or interfering with other moving parts.
 - Hydraulic fluid is not leaking.
3. If there are any problems, shutdown the machine and correct problems immediately.

If you need additional assistance, contact your local Raven dealer or the Raven Customer Support Center at 1-800-243-5435.

CHAPTER

6

Wiring and Electrical Connections

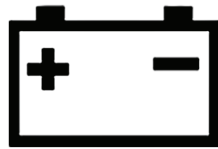

⚠ CAUTION

Ensure that the power cable is the last cable connected.
Do not reverse the power leads. Doing so will cause severe damage to the equipment.
Ensure the leads are connected to the correct polarity.

Connecting the SmarTrax Hydraulic Valve

1. Place a solenoid gasket (included in the packet with the console cable harness) on the solenoid installed in port '1A' on the SmarTrax hydraulic valve (P/N 334-0003-066).
2. Locate the connector labeled 'LEFT' on the SmarTrax console cable harness (P/N 115-0171-775).
3. Insert the connector labeled 'LEFT' to the solenoid installed in port '1A' on the SmarTrax hydraulic valve.
4. Tighten the bolt on the solenoid connector to secure the connection and to help prevent moisture penetration.
5. Repeat step 1 through step 4 to connect the 'RIGHT' connector to the solenoid on port '1B'.

FIGURE 1. Solenoid Connections on the SmarTrax Valve

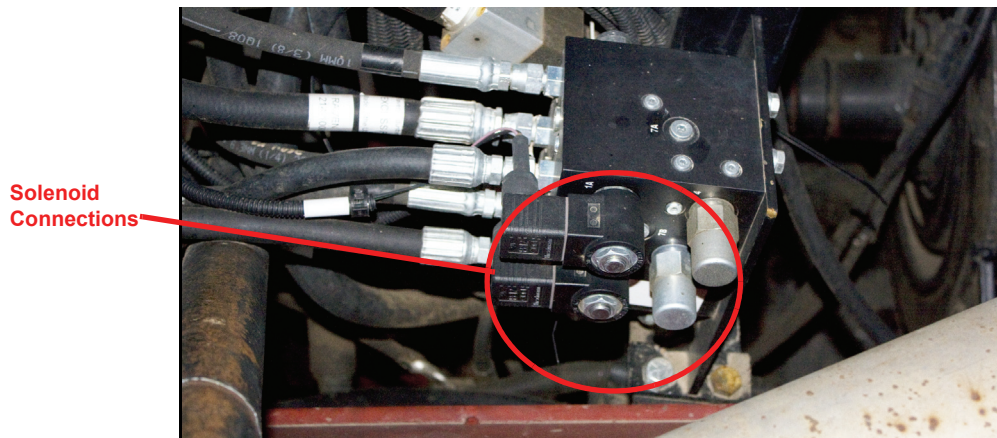

Connecting the Pressure Override Switch

1. On the console cable harness (P/N 115-0171-775), identify the connector labeled 'OVERRIDE'.
2. Connect the 'OVERRIDE' connector to the pressure override switch.
3. Tighten the bolt on the connector to secure the connection and to help prevent moisture penetration.

Route the Console Cable Harness

Once the SmarTrax hydraulic valve and pressure override switch are connected to the console cable harness, the remaining connectors must be routed into the cab.

1. Locate an access point through which the console cable harness (P/N 115-0171-775) may be routed into the cab.
2. Route the cable to the access point and use the provided cable ties to secure the cable to avoid catching or damaging the cable during normal equipment operation.

Note: *When routing the SmarTrax console cable harness, follow the path of other hoses or cables to avoid potential wear areas.*

3. Feed enough of the cable into the cab to allow each cab control component to be connected.
4. Spool and secure any excess cable.

Install the Foot Switch

1. Select a location for the SmarTrax foot switch (P/N 063-0172-470) within easy reach of the operator to fully press the front of the pedal.
2. Use the SmarTrax foot switch as a template and pre-drill holes in the floor.
3. Secure the foot switch to the floor with four screws or bolts through each of the mounting holes.
4. Locate the connector labeled 'ENABLE' on the SmarTrax console cable harness (P/N 115-0171-775) and connect it to the foot switch cable.

FIGURE 2. Foot Switch Mounting Example



Mount the SmarTrax Controller

When choosing the location for the SmarTrax controller, consider the following points:

- The controller is not weatherproof. Mount the controller in the vehicle's cab within easy reach of the operator.
- Mount the controller in a location where it will not impede the operator's ability to control the vehicle and where other components within the cab will not strike or jar the controller during normal operation.
- Ensure that all cabling is routed to avoid tripping hazards and prevent crimping or breaking the cables during normal operation.

To Install the SmarTrax Controller

1. Select the preferred location for the controller using the previous recommendations and mount the controller.
2. Connect the large, round connector on the SmarTrax console cable harness (P/N 115-0171-775) to the back of the controller box.
3. Connect your receiver or source of DGPS to the connector labeled 'DGPS.'
4. Connect the console or lightbar providing machine guidance to the connector labeled 'LIGHTBAR.'
5. Insert the power cable (P/N 115-0171-465) to the Power connector on the controller box.
6. Route the power leads to the vehicle's battery and connect.
 - a. Connect the red power lead on the positive battery terminal.
 - b. Connect the black power lead on the negative battery terminal.

Install the Yaw Sensor

When choosing the location for the yaw sensor, consider the following points:

- The yaw sensor is not weatherproof. Mount the sensor inside the cab.
- Mount the yaw sensor in a location away from foot traffic.
- Mount the yaw sensor to a flat, level surface. The floor of the cab is generally ideal.
- Mount the yaw sensor so that the Raven logo faces up.
- The SmarTrax yaw sensor does not need to be oriented toward the direction of vehicle travel.

Note: *If you are going to use the double-sided tape to mount the SmarTrax yaw sensor, be sure to thoroughly clean and dry the mounting location first.*

To Install the Yaw Sensor

1. Select the preferred location for the SmarTrax yaw sensor (P/N 063-0172-684). See the recommendations for choosing a mounting location above.
2. Mount the yaw sensor using one of the following methods:
 - Remove the protective covering from the double-sided tape and affix the yaw sensor to the floor.
 - Using the yaw sensor as a template, mark and pre-drill holes in the floor. Using bolts or screws (not supplied), secure the yaw sensor in position.
3. Locate the connector labeled 'YAW SENSOR' on the SmarTrax console cable harness (P/N 115-0171-775).
4. Insert this connector to the yaw sensor cable connection.

FIGURE 3. Yaw sensor Model

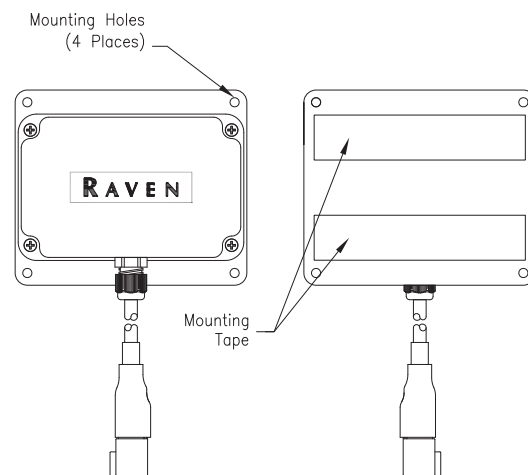

Install the SmarTrax Node

When choosing the location for the SmarTrax node, consider the following points:

- The node is not weatherproof. Mount the SmarTrax node inside the machine's cab or driver's compartment.
- The node mounting location must not create tripping hazards and allow cable routing to avoid crimping or damaging the cables or the node connections.
- Mount the SmarTrax node to a flat surface with two of the arrows on the node parallel to the ground and in a location where it will not be kicked or jarred during normal equipment operation.
- One of the six numbered direction arrows on the node must be oriented in the direction of forward vehicle travel. Note the number of the arrow corresponding to forward travel for SmarTrax calibration. One arrow must also point straight up.
- Mount the node to a flat, level surface. The floor of the cab is generally ideal.
- Securely fasten the node using bolts or screws through at least two of the three mounting holes. When mounted properly, the node should not become loose or rotate.

FIGURE 4. Node Mounting

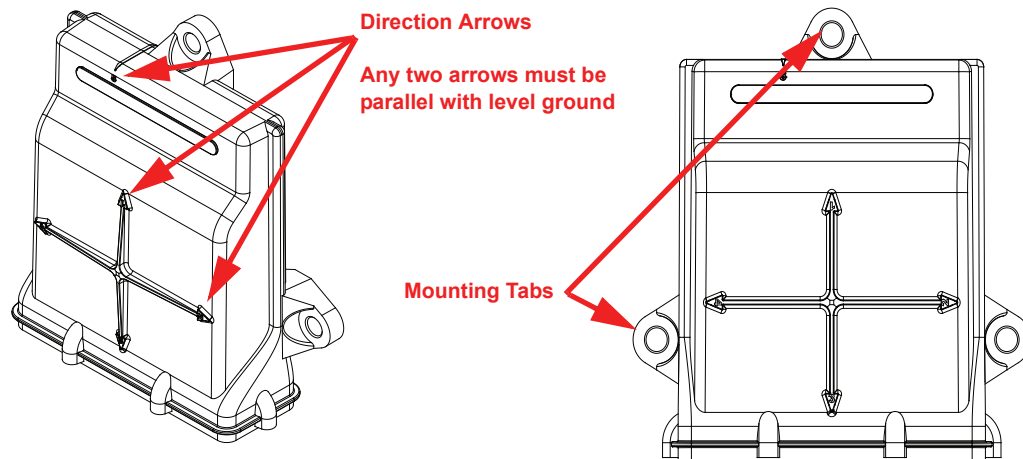

To Install the Node:

1. Select the preferred location for the node. See the recommendations for choosing a mounting location above.
2. Using the mounting tabs on the node as a template, mark and pre-drill holes. Using bolts or screws (not supplied), secure the node in position.
3. Connect the large, round connectors on the node adapter cable (P/N 115-4001-007) for Viper Pro/Envizio Pro or (P/N 115-4001-018) for Cruiser to the SmarTrax console cable harness (P/N 115-0171-775).
4. Connect the large, rectangular connectors to the SmarTrax node.
5. Connect your receiver or source of DGPS to the connector labeled 'DGPS' on the node adapter cable.
6. Connect the console providing machine guidance to the remaining small, round connector.
7. Connect the 4-pin deutsch plug to the vehicle's CANbus system (Viper Pro/Envizio Pro) or the DB-9 display cable (Cruizer).
8. Electrical hookup is recommended as shown in the *Can Node Wiring Diagram* on page 26.

Note: *High Current Power, which is used to run steering operations, should be connected to a separate power source than Logic Power, which is used to run processing and communication between the node and the guidance console.*

FIGURE 5. Cable Harness Installation Schematic

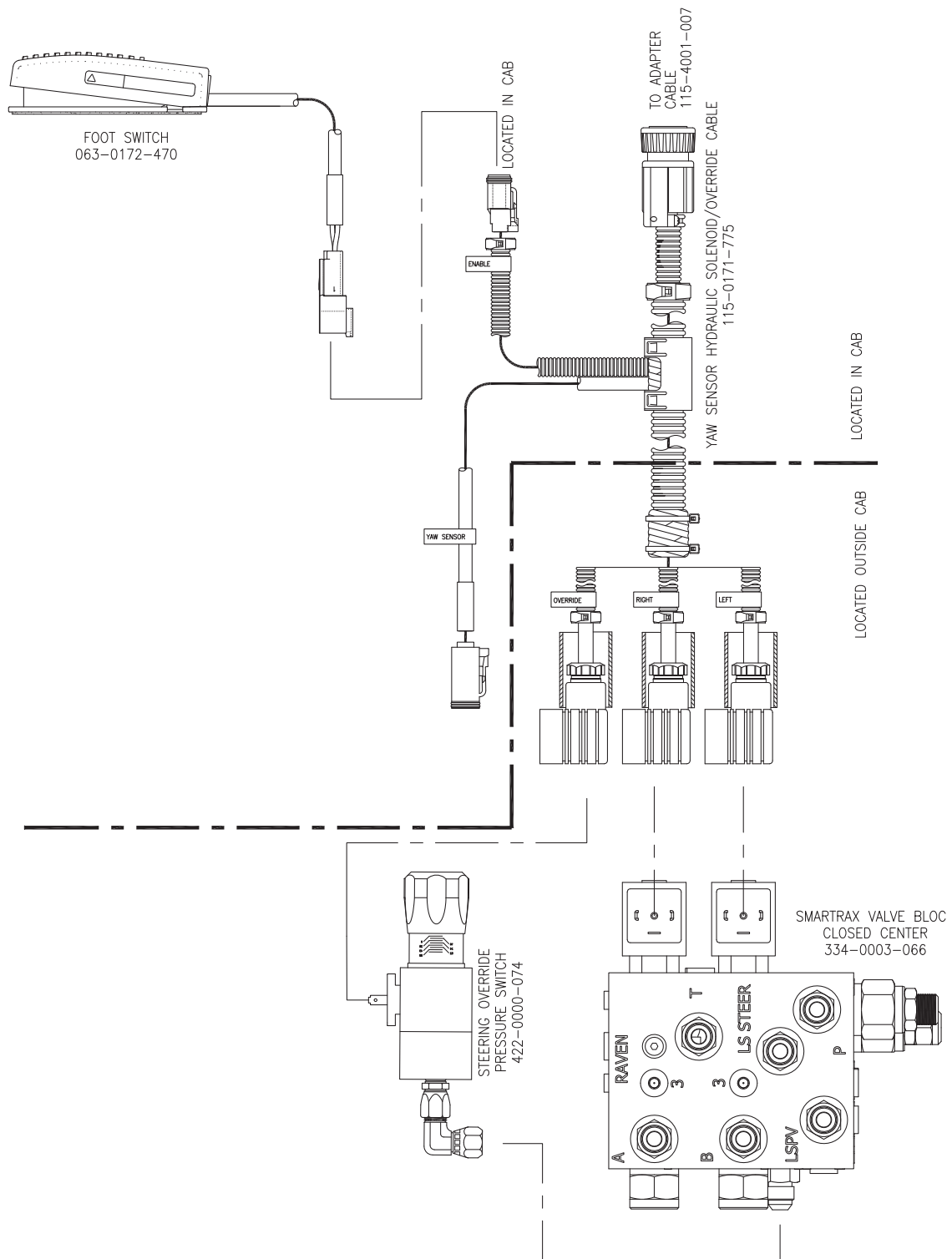

CHAPTER

7

System Drawings



The following diagrams may be helpful for installing or troubleshooting the SmarTrax system. The following diagrams may show optional features or components not required for operation and will not apply to your system if the required hardware has not been installed.

Contact your local dealer for purchasing or more information on components shown in the following diagrams.

Additional system diagrams are available from the Raven Industries web site:

<http://www.ravenprecision.com/Support/ApplicationDrawings/index2.jsp>

Can Node Wiring Diagram

CAN NODE WIRING

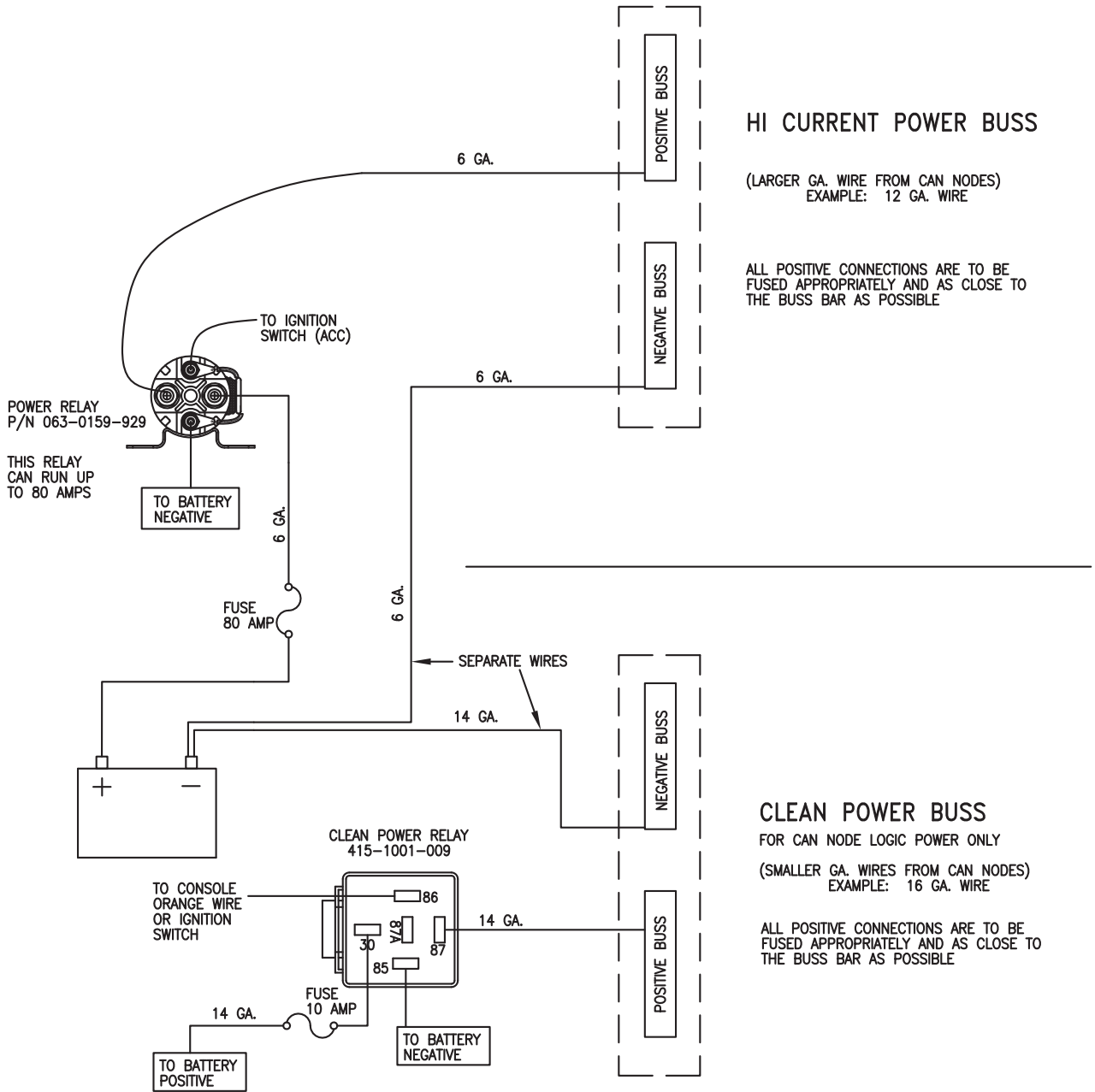

Envizio Pro/ Viper Pro

ENVIZIO PRO/VIPER PRO CAN SMARTRAX/SMARTRAX 3D W/PHONEIX 300

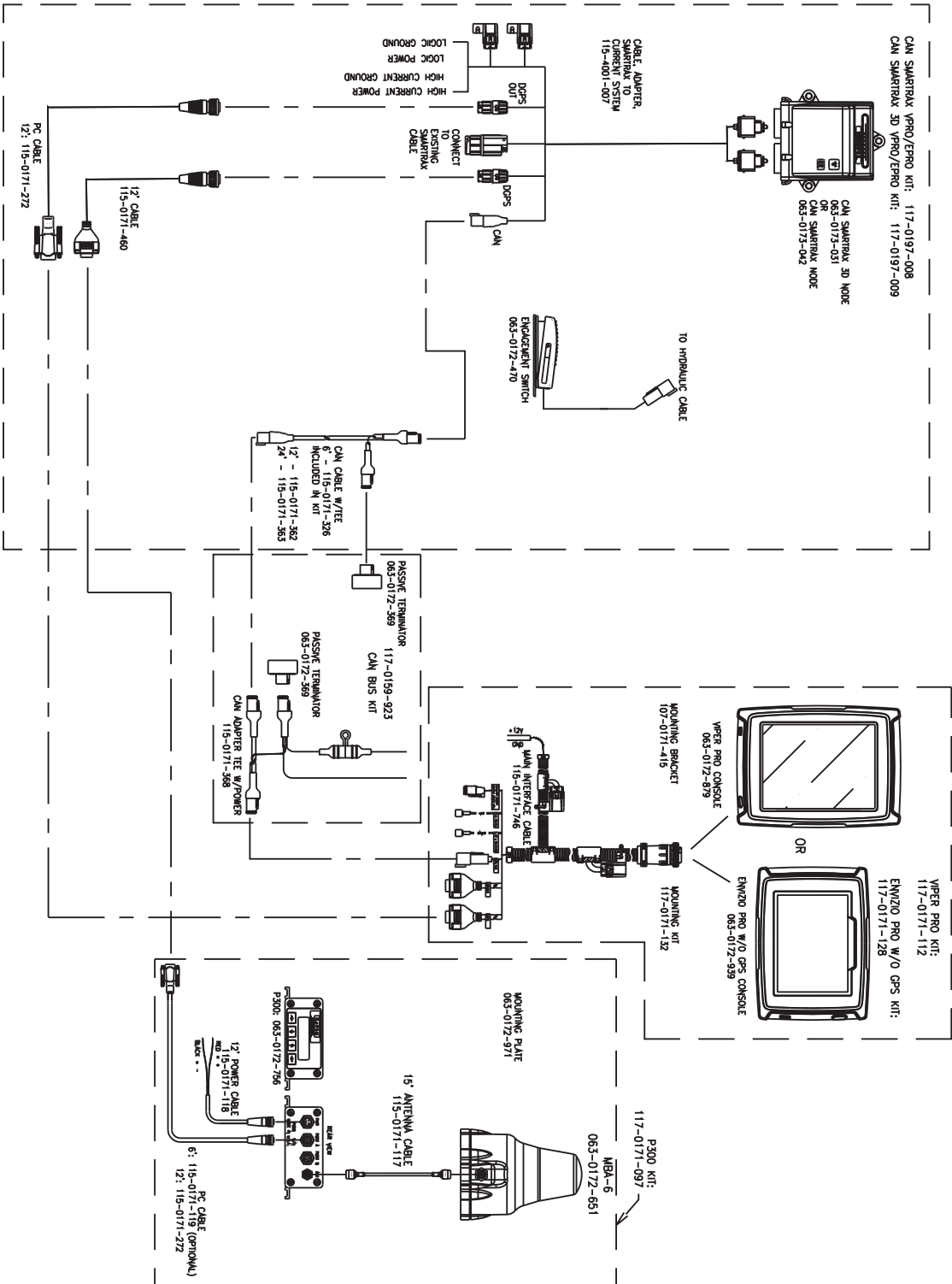

ENVIZIO PRO/VIPER PRO CAN SMARTRAX/SMARTRAX 3D UPGRADE W/PHOENIX 200, TM-1

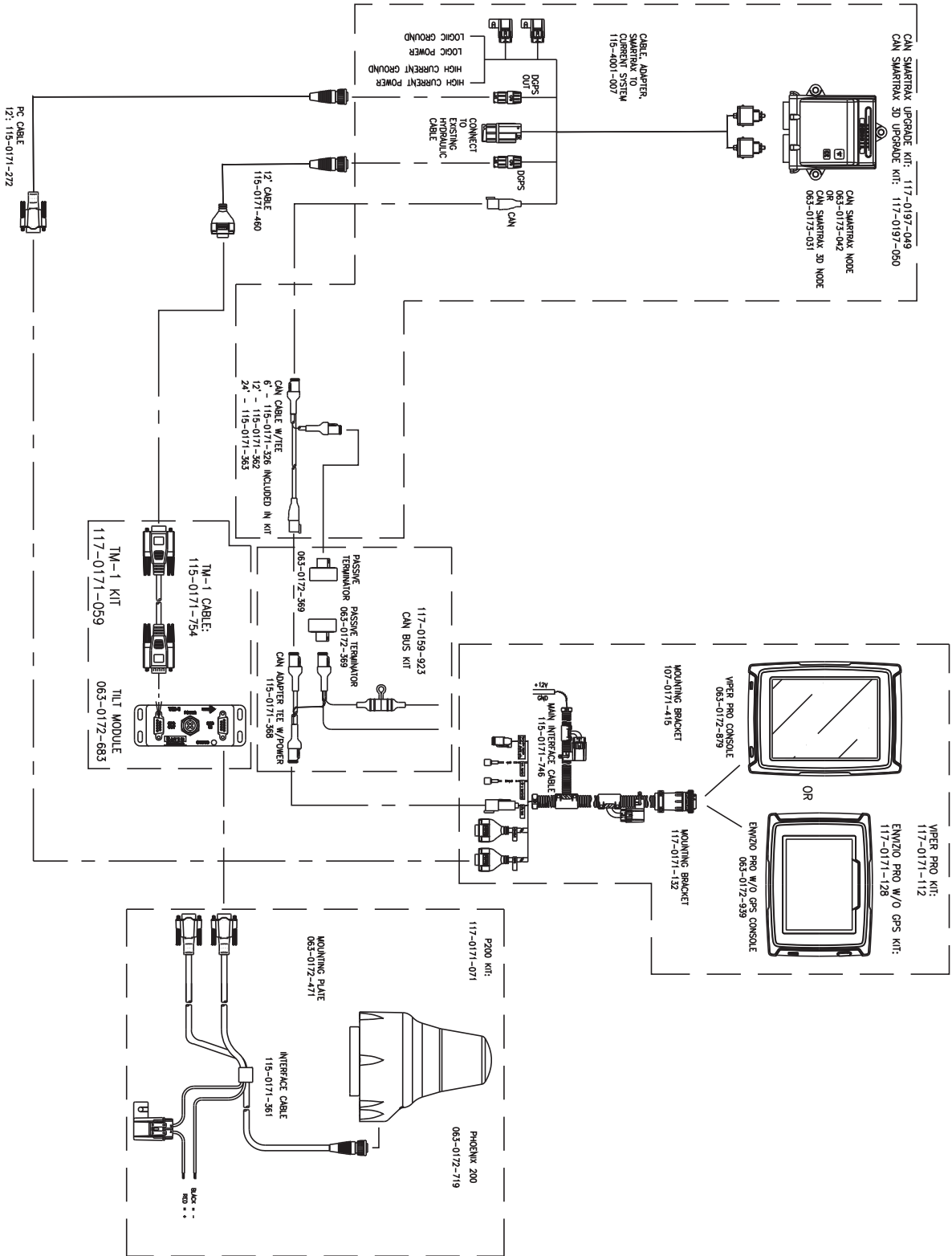

VIPER PRO WITH GPS, SMARTRAX, TM-1 AND EXTERNAL LIGHTBAR

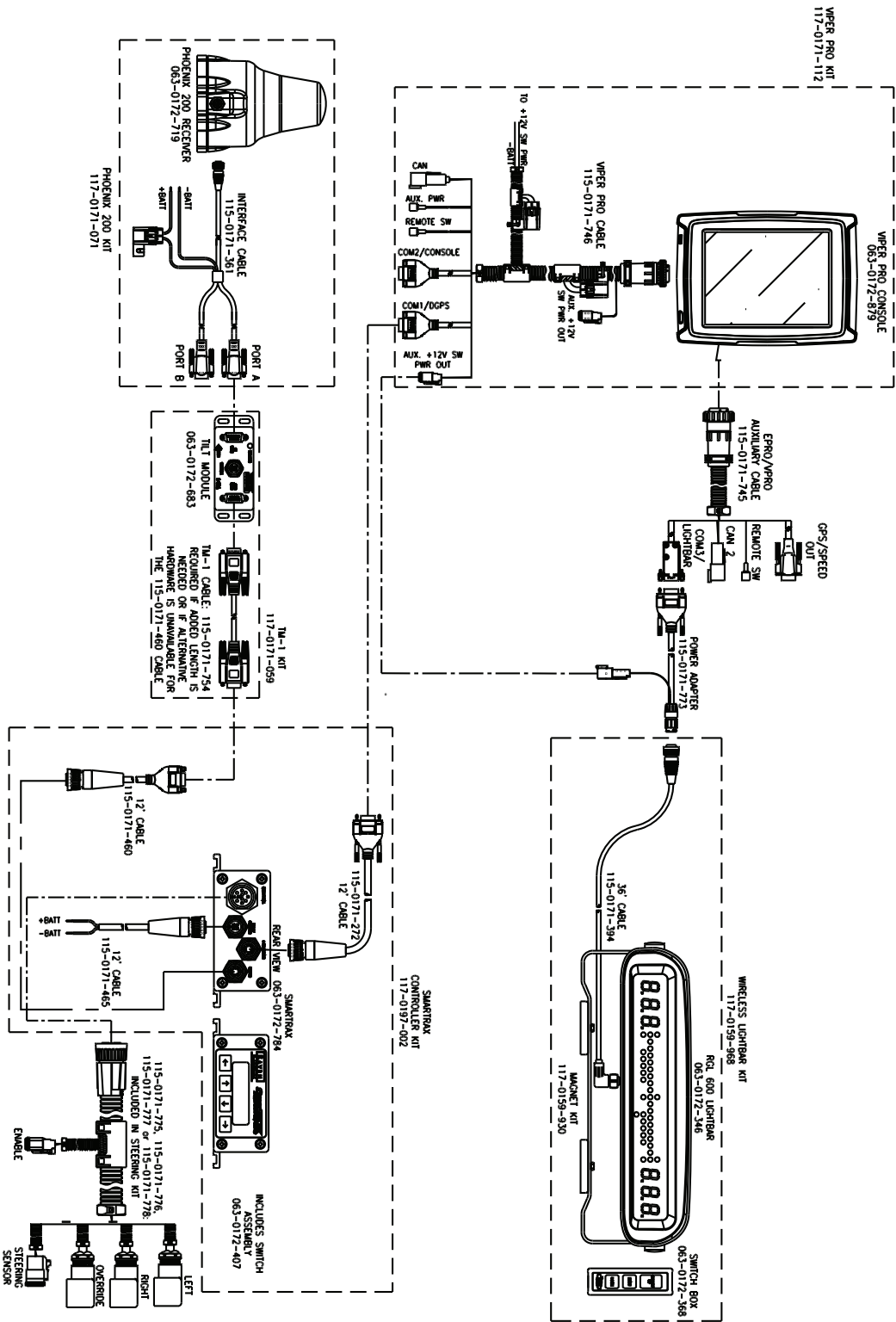

ENVIZIO PRO W/GPS/RGL 600 CAN SMARTRAX/SMARTRAX 3D

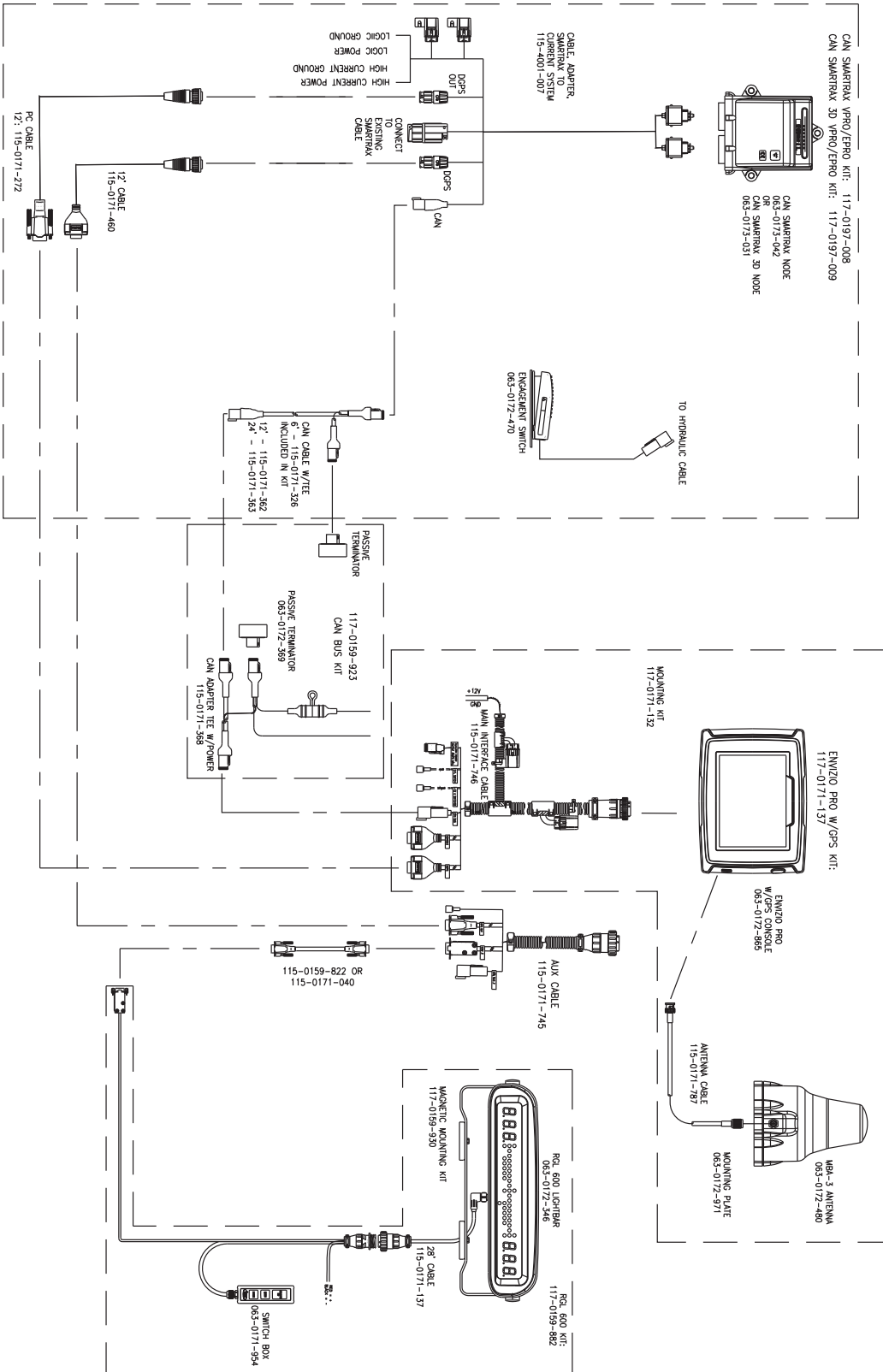

Cruizer

CRUIZER WITH HELIX ANTENNA, SMARTRAX/SMARTRAX 3D

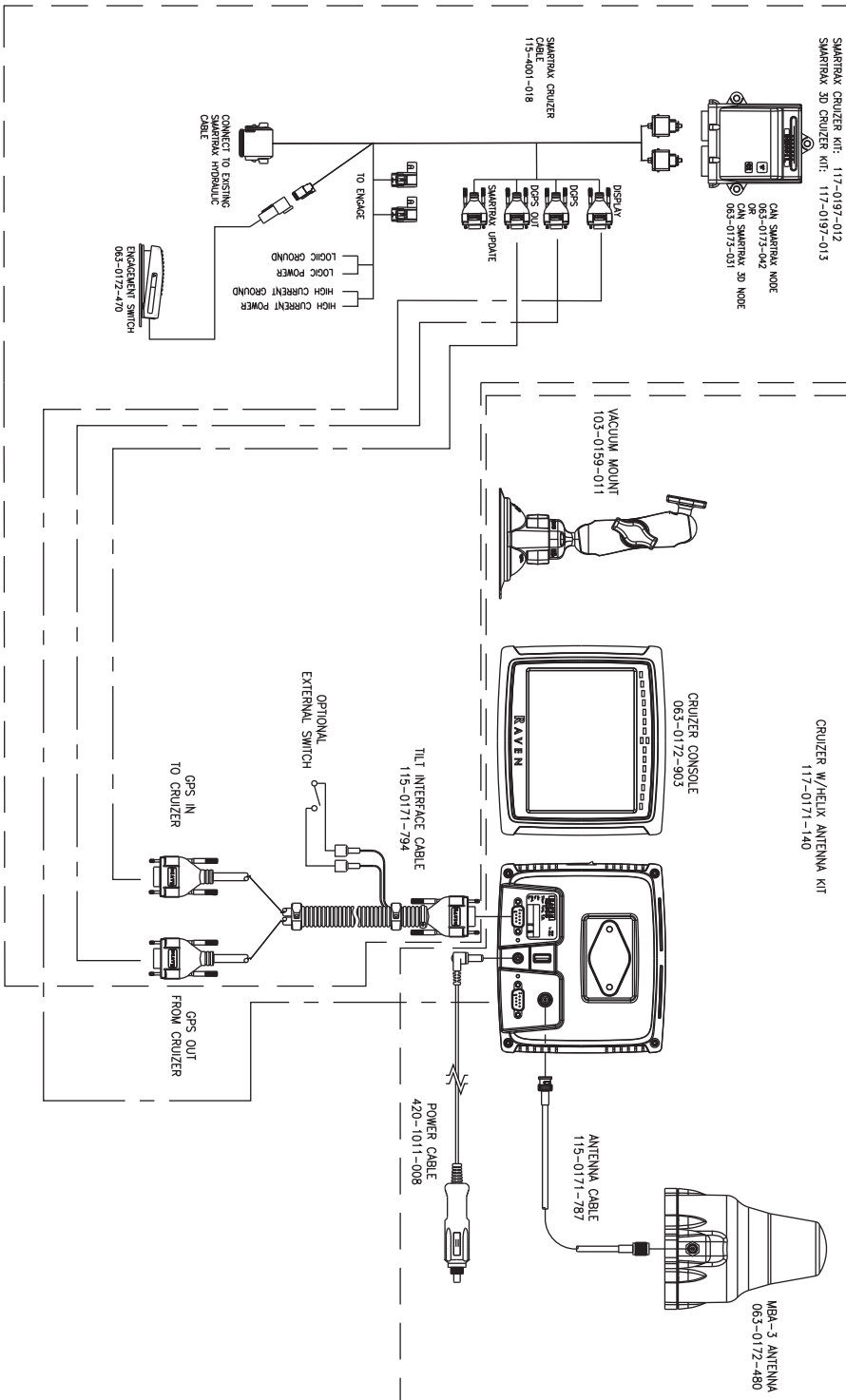

A

Affixing the SmarTrax Tampering Warning Label 10

C

CAN Node Wiring Diagram 23
Console Cable Harness Routing 20

H

Hydraulic Connection Diagram 16
Hydraulic Connections 11

I**Installation**

Foot Switch 21
Recommendations
 SmarTrax Controller 21, 23
 Yaw Sensor 22
Yaw Sensor 22

K

Kit Contents 5

L

Left Steer Hose- Installation 12

M

Mount the SmarTrax Hydraulic Valve 9

P**Preparing for Installation** 4

Point of Reference 4
Recommendations 4
Tools Needed 4

Pressure Hose- Installation 13

Pressure Switch- Installation 15

S**Safety Information** 1

Electrical Safety 2
Hydraulic Safety 2

Start-Up Procedures

Verify the SmarTrax Installation 18

System Drawings 25

W**Wiring & Electrical Connections**

Pressure Override Switch 20
SmarTrax Hydraulic Valve 19

Wiring and Electrical Connections 19

RAVEN

RAVEN INDUSTRIES

Limited Warranty

What Does this Warranty Cover?

This warranty covers all defects in workmanship or materials in your Raven Applied Technology Product under normal use, maintenance, and service.

How Long is the Coverage Period?

Raven Applied Technology Products are covered by this warranty for 12 months after the date of purchase. This warranty coverage applies only to the original owner and is nontransferable.

How Can I Get Service?

Bring the defective part and proof of purchase to your Raven Dealer. If your Dealer agrees with the warranty claim, the Dealer will send the part and proof of purchase to their distributor or to Raven Industries for final approval.

What Will Raven Industries Do?

Upon confirmation of the warranty claim, Raven Industries will, at our discretion, repair or replace the defective part and pay for return freight.

What is not Covered by this Warranty?

Raven Industries will not assume any expense or liability for repairs made outside our facilities without written consent. Raven Industries is not responsible for damage to any associated equipment or products and will not be liable for loss of profit or other special damages. The obligation of this warranty is in lieu of all other warranties, expressed or implied, and no person or organization is authorized to assume any liability for Raven Industries.

Damages caused by normal wear and tear, misuse, abuse, neglect, accident, or improper installation and maintenance are not covered by this warranty.

R A V E N

Caselh 91xx, 92xx, and 93xx Series
SmarTrax™ Installation Manual
(P/N 016-0190-043 Rev D 11/09)

Simply improving your position.™



Raven Industries
Applied Technology Division
P.O. Box 5107
Sioux Falls, SD 57117-5107

Toll Free (U.S. and Canada): (800)-243-5435
or Outside the U.S. :1 605-575-0722

Fax: 605-331-0426

www.ravenprecision.com
atdinfo@ravenind.com

Notice: This document and the information provided are the property of Raven Industries, Inc. and may only be used as authorized by Raven Industries, Inc. All rights reserved under copyright laws.