

SmartBoom and SmartRow Installation and Calibration Manual

P/N 016-0171-093 Rev E

06/15

Disclaimer

While every effort has been made to ensure the accuracy of this document, Raven Industries assumes no responsibility for omissions and errors. Nor is any liability assumed for damages resulting from the use of information contained herein.

Raven Industries shall not be held responsible or liable for the effects of atmospheric conditions and sunspot activity on the performance of our products.

Raven Industries cannot guarantee the accuracy, integrity, continuity, or availability of the GPS signal from the U.S. Department of Defense/NAVSTAR GPS satellites, the OmniSTAR correction service or the WAAS correction service.

Raven Industries accepts no responsibility for the use of the signal for other than the stated purpose. Raven Industries shall not be responsible or liable for incidental or consequential damages or a loss of anticipated benefits or profits, work stoppage or loss or impairment of data arising out of the use, or inability to use, the SmarTrax or any of its components.

CHAPTER 1	<i>Important Safety Information</i>	1
	Electrical Safety	2
CHAPTER 2	<i>Introduction</i>	3
	Overview of the SmartBoom/SmartRow Installation and Calibration Process	3
	Updates	4
	Functional Description	4
CHAPTER 3	<i>SmartBoom/SmartRow Installation</i>	5
	Mounting	5
	Power	5
	GPS Receiver	6
	Cruizer Connection	6
	Console Connection (SmartBoom Only)	6
	Interface Cable	7
	Master Switch	7
CHAPTER 4	<i>SmartBoom Operation</i>	9
	Initial Startup	9
	About SmartBoom Jobs	10
	Standard SmartBoom Job	11
	SmartBoom Job with Field Boundary	11
	SmartBoom Job with No Spray Zones	11
	SmartBoom Job with Field Boundary and No Spray Zones	11
	Additional SmartBoom Features	12
	Look Ahead	12
	Percent Coverage	12
	SmartBoom Override	12
	Manual Control	13
CHAPTER 5	<i>SmartBoom Front Panel Display</i>	15
	Display Setup	15
	Home Display Screen	17
	Manual Control Screen	17
	Left Boom Control	18
	Right Boom Control	18

Table of Contents

Manual Control When Stopped	19
Returning Home	19
Field Boundary Menu	19
Field Boundary Offset Screen	20
Start Field Boundary Screen	21
End Field Boundary Screen	21
No Spray Zone Menu	22
No Spray Zone Offset Screen	23
Start No Spray Zone Screen	23
End No Spray Zone Screen	24
CHAPTER 6 SmartRow Operation	27
Initial Startup	27
About SmartRow Jobs	28
Standard SmartRow Job	29
SmartRow Job with Field Boundary	29
SmartRow Job with No Plant Zones	29
SmartRow Job with Field Boundary and No Plant Zones	29
Additional SmartRow Features	30
Look Ahead	30
Percent Coverage	30
SmartRow Override	31
Manual Control	31
CHAPTER 7 SmartRow Front Panel Display	33
Display Setup	33
Home Display Screen	35
Manual Control Screen	36
Left Section Control	36
Right Section Control	36
Manual Control When Stopped	37
Returning Home	37
Field Boundary Menu	37
Field Boundary Offset Screen	38
Start Field Boundary Screen	39
End Field Boundary Screen	39
No Plant Zone Menu	40
No Plant Zone Offset Screen	41
Start No Plant Zone Screen	41

End No Plant Zone Screen	43
CHAPTER 8 SmartBoom/SmartRow Configuration Screens	45
Sections Configuration Menu	45
Number of Sections Screen	46
Section Width Screens	47
L/R Offset Screen	48
F/A Offset Screen	49
Autolocate Sections Screen	50
Individual L/R Offset Screen	51
Individual Fore/Aft Offset Screen	52
Controller Configuration Menu	53
Control All Sctns Screen	54
Control Section Screens	55
On Look Ahead Screen	56
Off Look Ahead Screen	57
Percent Coverage Screen	58
Override Time Screen	59
Test Cycle Sections Screen	60
System Configuration Menu	61
LCD Backlight Screen	62
LCD Contrast Screen	62
Key Beep Screen	63
Distance Unit Screen	64
Baud Rate Screens	65
Console Port Screen (SmartBoom Only)	66
Master Switch Screen	67
Receiver Remote Screen	68
Lockout Settings Screen	69
Language Settings Screen	70
Mode Selection Screen	71
CHAPTER 9 SmartBoom Cruizer Interface and Calibration	73
Sprayer Section Configuration	75
Sprayer Screen	76
Look Ahead	76

Table of Contents

Percent Coverage	76
SmartBoom Override	76
Sprayer Controller Setup Screen	77
Guidance Screen	78
Field Review Screen	79
SmartBoom Modes	80
Standard SmartBoom Job	80
No Spray Zone Mapping Mode	80
Field Boundaries	80

CHAPTER 10 SmartRow Cruiser Interface and Calibration 83

Planter Section Configuration	85
Planter Screen	87
Look Ahead	87
Percent Coverage	87
SmartRow Override	87
Planter Controller Setup Screen	88
Guidance Screen	89
Field Review Screen	90
SmartRow Modes	91
Standard SmartRow Job	91
No Plant Zone Mapping Mode	91
Field Boundaries	91

CHAPTER 11 SmartBoom/SmartRow Troubleshooting 95

Check the Installation	95
Check for Power	95
Check for GPS Reception	96
Check for GPS Communication	96
Check for Console Communication (SmartBoom Only)	96
Check Baud Rate Settings (Cruizer Connection Only)	97
Clear NV memory in SmartBoom/SmartRow (Cruizer Connection only) Error Messages	
98	
Error Messages	99
Mechanical Problems	100

CHAPTER 12 System Drawings..... 101

CHAPTER

1

*Important Safety
Information*

NOTICE

Read this manual carefully before installing the SmartBoom/SmartRow system.

- Follow all safety information presented within this manual.
- If you require assistance with any portion of the installation or service of your Raven equipment, contact your local Raven dealer for support.
- Follow all safety labels affixed to the SmartBoom/SmartRow system components. Be sure to keep safety labels in good condition and replace any missing or damaged labels. To obtain replacements for missing or damaged safety labels, contact your local Raven dealer.

When operating the machine after installing SmartBoom/SmartRow, observe the following safety measures:

- Be alert and aware of surroundings.
- Do not operate SmartBoom/SmartRow or any agricultural equipment while under the influence of alcohol or an illegal substance.
- Remain in the operator's position in the machine at all times when SmartBoom/SmartRow is engaged.
- Disable SmartBoom/SmartRow when exiting from the operator's seat and machine.
- Do not drive the machine with SmartBoom/SmartRow enabled on any public thorough-fare or main road.
- Determine and remain a safe working distance from other individuals. The operator is responsible for disabling SmartBoom/SmartRow when the safe working distance has diminished.
- Ensure SmartBoom/SmartRow is disabled prior to starting any maintenance work on SmartBoom/SmartRow or the machine.

Please review the operation and safety instructions included with your implement and/or controller.

 **WARNING**

When starting the machine for the first time, be sure that all persons stand clear, in case a hose has not been completely tightened.

This machine must remain stationary and switched off with the booms unfolded and supported while installation or maintenance is conducted.

 **CAUTION**

Electrical Safety

Do not reverse power leads. Doing so could cause severe damage to the equipment. Always make sure that the power leads are connected to the correct polarity as marked. Ensure that the power cable is the last cable to be connected.



CHAPTER
2

Introduction

Congratulations on your purchase of the SmartBoom/SmartRow automatic section control system! The SmartBoom/SmartRow system provides automatic control of your spray booms or planter by turning on and turning off sections based on either predefined spray/plant zones and/or previous coverage. SmartBoom is designed to augment your Raven SCS 440/450/460/660 or SCS 4400/4600 console and provide a complete spraying solution. SmartRow works with existing electric and air clutch systems to provide a complete planting solution. SmartBoom and SmartRow feature a Front Panel display to make configuring and operating the system easy and user friendly.

Overview of the SmartBoom/SmartRow Installation and Calibration Process

The following table lists the steps you must take in order to install and operate the SmartBoom/SmartRow system and which chapters contain detailed instructions about those steps.

TABLE 1. SmartBoom/SmartRow Installation and Operation Overview

For information about this step...	See this chapter...
Installation	Chapter 3
SmartBoom Operation	Chapter 4
SmartBoom Front Panel Display	Chapter 5
SmartRow Operation	Chapter 6
SmartRow Front Panel Display	Chapter 7
Configuration Screens	Chapter 8
SmartBoom Cruiser Interface and Calibration	Chapter 9
SmartRow Cruiser Interface and Calibration	Chapter 10
Troubleshooting	Chapter 11

Updates

Updates for Raven manuals as well as software updates for Raven consoles are available at the Applied Technology Division web site:

<http://www.ravenprecision.com/Support/index2.jsp>

Sign up for e-mail Alerts and we will notify you when updates for your Raven products are available on the Raven web site.

Functional Description

The SmartBoom/SmartRow system consists of three components.

- SmartBoom/SmartRow Controller Box
- Raven Cruiser Console or SCS 440/450/460/660/4400/4600 Console (SmartBoom Only)
- Planter Clutches (SmartRow)
- GPS Receiver or Cruiser

The GPS receiver supplies the instantaneous position of the vehicle while the SmartBoom/SmartRow continually monitors the information from the antenna to create an as-applied map of activity. If the machine enters a previously sprayed/planted area, SmartBoom/SmartRow determines that the sections should be turned off.

CHAPTER

3

*SmartBoom/
SmartRow Installation*

Mounting

1. Mount the SmartBoom/SmartRow controller using the elongated holes in the flange assembly.
2. Tighten the support screws securely to prevent jarring or bouncing of the SmartBoom/SmartRow controller.

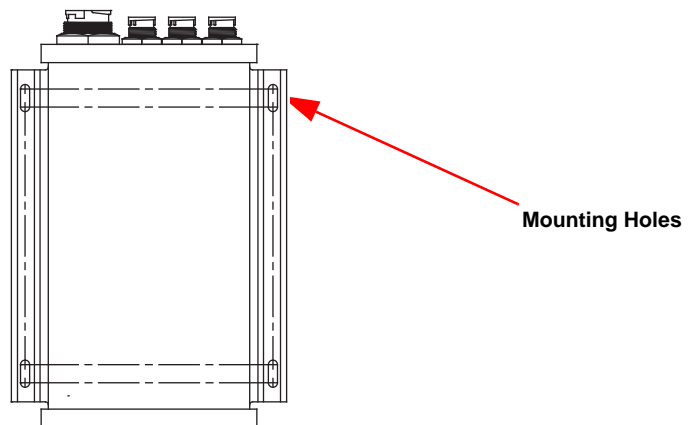

FIGURE 1. SmartBoom/SmartRow Console

Power

When used in the SmartBoom application, the controller will power up when the console is turned on. When used in the SmartRow application, the controller will power up when power and ground are applied to the Tractor Power Cable.

GPS Receiver

SmartBoom/SmartRow must receive a GPS signal from a GPS receiver in order to know where the sections are located. Any GPS receiver that supplies the standard NMEA GPS strings at a minimum of 4 Hz can be used.

Connect the supplied GPS Interface Cable (P/N 115-0171-460) to the round connector labeled DGPS on the back of SmartBoom/SmartRow. Connect the 9-pin connector on the other end of the GPS Interface Cable (P/N 115-0171-460) to the mating connector on the GPS receiver.

Cruizer Connection

Connect the supplied optional Cruizer Interface Cable (P/N 115-0171-835) to the round connector labeled DGPS on the back of SmartBoom/SmartRow. Connect the 9-pin connector on the other end of the GPS Interface Cable (P/N 115-0171-835) to Port A.

Console Connection (SmartBoom Only)

SmartBoom receives information on boom status from the Raven control console. In order for SmartBoom to receive section information, a serial interface cable must be connected between the Raven control console and SmartBoom.

Connect the supplied serial console communications cable (P/N 115-0171-119) to the circular connector labeled "Console" on the back of SmartBoom. Connect the 9-pin connector on the other end of the cable to the corresponding 9-pin jack on the back of the Raven control console or on the console harness.

Note: *For 4400/4600 consoles, make sure you set the Data Direct menu to "Pass through communications port" and the stop bits to "2 stop bits." Also, ensure the baud rate for port C on the SmartBoom/SmartRow controller matches the baud rate for the serial port of your SCS console, typically 9600.*

If you are installing SmartBoom on a machine without a Raven console, you do not need to connect a console with the serial connection. Make sure SmartBoom Console Port option is set to "None." See the Sections Configuration Menu section in Chapter 8 for more information on using the Console Port Screen.

Interface Cable

SmartBoom interfaces to the booms through the Raven console cable. The SmartBoom interface cable is installed by teeing in between a Raven console and the console cable.

SmartRow interfaces to the planter clutches through the Tractor Power Harness. The SmartRow interface cable is installed by routing cable back to the planter clutches.

Connect the large round connector from the SmartBoom/SmartRow Interface Cable to the large circular connector on the back of the SmartBoom/SmartRow. If you are connecting the SmartBoom/SmartRow controller to a Raven console, disconnect the console cable from the back of the Raven Control Console and connect the SmartBoom/SmartRow Interface Cable to the console cable port. Connect the other side of the tee on the Interface cable to the console cable. If your console has a master switch on the console (440, 450, 4400), installation is now complete.

Master Switch

If you have a console that does not have a master switch, or a non-Raven console, you will need to connect the orange wire with a white stripe to the master switch on the sprayer.

For planters, the implement switch is included and connected on the planter.

The SmartBoom/SmartRow controller can be set up to act as a soft switch to enable/disable SmartBoom/SmartRow section control. See the Sections Configuration Menu section on page 45 for more information on the Master Switch screen.



Initial Startup

Before beginning your first application, you need to install and configure SmartBoom for your sprayer. Refer to the following points to set up SmartBoom. This ensures that SmartBoom is configured for the specific equipment with which it will be operating.

1. Set up the GPS System - Refer to your GPS receiver operator's manual to set up your GPS receiver to output a GPS signal to SmartBoom. SmartBoom requires both GGA position and VTG speed messages from the receiver. Message output rates should be at least 4 Hz. An output rate of 10 Hz is recommended.
2. Set up the Product Controller- Ensure the baud rate for port C on the SmartBoom controller matches the baud rate for the serial port of the SCS console.
3. Select the Sprayer mode from the System Config menu.
4. Select Distance Units - Use the SmartBoom Section Configuration Menus to set up the units that SmartBoom will use to measure. You can select inches or centimeters.
5. Configure The Sections Widths - Use the SmartBoom Boom Configuration Menus to set up the number of section and the width of each section.
6. Orient the implement with respect to the GPS antenna - Use the SmartBoom Boom Configuration Menus to enter the location of the center of the implement with respect to the GPS Antenna.

7. Configure the Implement Locations - If this is a standard boom configuration, use the SmartBoom Autoloaded feature to configure the location of each boom section with respect to the GPS antenna. If a custom boom configuration is used, use the optional boom configuration screens to set the location of each boom section with respect to the GPS Antenna.

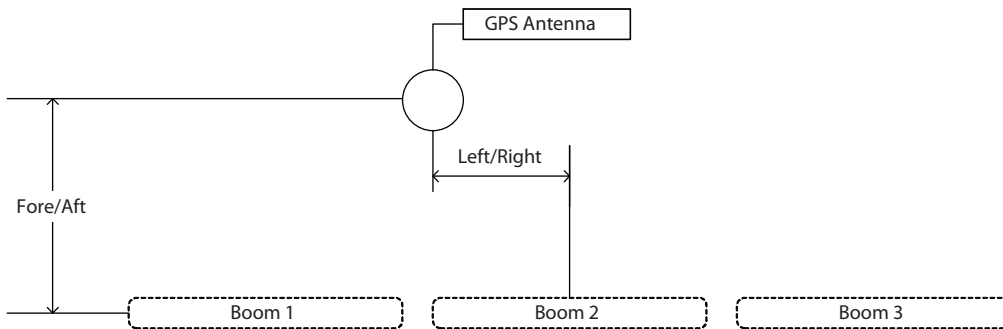

FIGURE 1. Boom Location Example





8. Set the Look Ahead Times - Use the SmartBoom Configuration menus to set the Turn On and Turn Off Look Ahead Times. The default setting is 0.1 seconds.
9. Set the Override Time - Use the SmartBoom Configuration menus to set the Override Time. The default setting is 5 seconds.
10. Set the Percent Coverage - Use the SmartBoom Configuration menus to set the Percentage Coverage. The default setting is 100 percent.
11. Select The Booms To Be Controlled - Use the SmartBoom Configuration menus to select which booms will be controlled by SmartBoom. The default setting allows SmartBoom to control all boom sections.

About SmartBoom Jobs

SmartBoom provides several methods of operation. These include:

- Standard Job
- Job With Field Boundary
- Job With No Spray Zones
- Job With Field Boundary And No Spray Zones

Standard SmartBoom Job

The simplest way to use SmartBoom is to start a job and begin spraying. From the Home screen, press  to display the Start New Job screen. Use the  or  key to toggle between yes or no. Select “Yes”. Then, press  to lock in your selection and to start a new job. SmartBoom will generate an as-applied map of spray activity. If you enter an area that has already been sprayed, SmartBoom automatically turns off the boom or booms that have entered the previously sprayed area.

SmartBoom Job with Field Boundary

If you are concerned about not applying any product outside of a field, you can create a no spray field boundary when you start a job. Use the Create Field Boundary feature during an initial pass around a field and SmartBoom monitors the location of the booms to create a field boundary. Once the field boundary is created, SmartBoom will automatically create a no spray zone of at least three boom widths around the field. During the rest of your application, SmartBoom will turn off any boom sections that enter the no spray zone outside the field boundary.

SmartBoom Job with No Spray Zones

Some fields have features that you do not want to spray like waterways or well heads. SmartBoom allows you to create up to eight no spray zones within a job. Simply select the no spray Zone Boundary Menus and follow the instructions. Once you have told SmartBoom that you want to create a no spray zone, you can continue to spray while you drive around the area on which you do not want to apply product. SmartBoom will create a no spray zone within the area you have sprayed around. During the rest of your application, SmartBoom will turn off any boom sections that enter this no spray zone.

SmartBoom Job with Field Boundary and No Spray Zones

For complete SmartBoom control, you can generate both a field boundary and up to eight no spray zones for a job. Simply use the field boundary and no spray zone menus on the SmartBoom and spray around the areas you do not want to spray. SmartBoom will create an as-applied map which includes a no spray field boundary and up to eight no spray zones within the field boundary.



Additional SmartBoom Features

SmartBoom provides additional features to permit optimum coverage capabilities for your specific application. These features include:

- Look Ahead
- Percent Coverage
- Override

Look Ahead



SmartBoom allows you to pre-program Turn-On and Turn-Off Look Ahead times. SmartBoom monitors the GPS position and as-applied map while considering the Look Ahead times to begin turning booms on or off before they cross spray or no spray boundaries. Look Ahead times can help compensate for delays in the sprayer system including the time it takes for boom valves to open and close. The specific Look Ahead time is a function of the valve timing and the speed at which the operator is driving the machine.

Percent Coverage

SmartBoom provides the ability to pre-define the amount of coverage SmartBoom will apply. For most applications that require complete coverage, the Percent Coverage should be set to 100 percent. For applications that will not tolerate overlap, the Percent Coverage should be set to a lower value.

SmartBoom allows a Percent Coverage value anywhere from 5 to 100 percent in increments of 5 percent.

SmartBoom Override

SmartBoom provides you the ability to momentarily override the SmartBoom feature and force all boom sections on. This may be desired if you want to double up coverage on an area of the field. The override feature is also used when starting off from a dead stop. Enable the SmartBoom Override feature and allow the boom valves to open up before driving ahead. The amount of time for the override can be modified from the Configuration menu. See “Override Time Screen” on page 59. From the Home screen, touch  and  at the same time to enable the SmartBoom Override feature.

Note: When the override feature is enabled, an “O” appears in the Home screen.

Manual Control

SmartBoom provides you with the ability to manually toggle individual boom sections on or off. Manual Control is useful in situations when parts of a boom section will overlap other crop areas.

CHAPTER

5

SmartBoom Front Panel Display

Display Setup

Gently peel away the protective film covering the Front Panel. The Front Panel display allows the user to configure the vehicles boom settings, SmartBoom control and settings, and to run a job with or without a field boundary and/or no spray zones. The keypad arrows are used to navigate through the display and configuration menus.

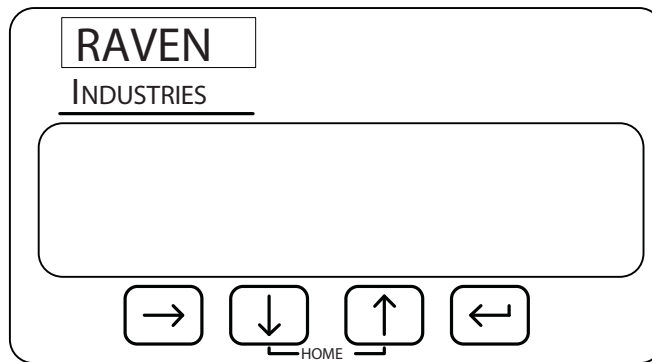

SmartBoom Menu Structure

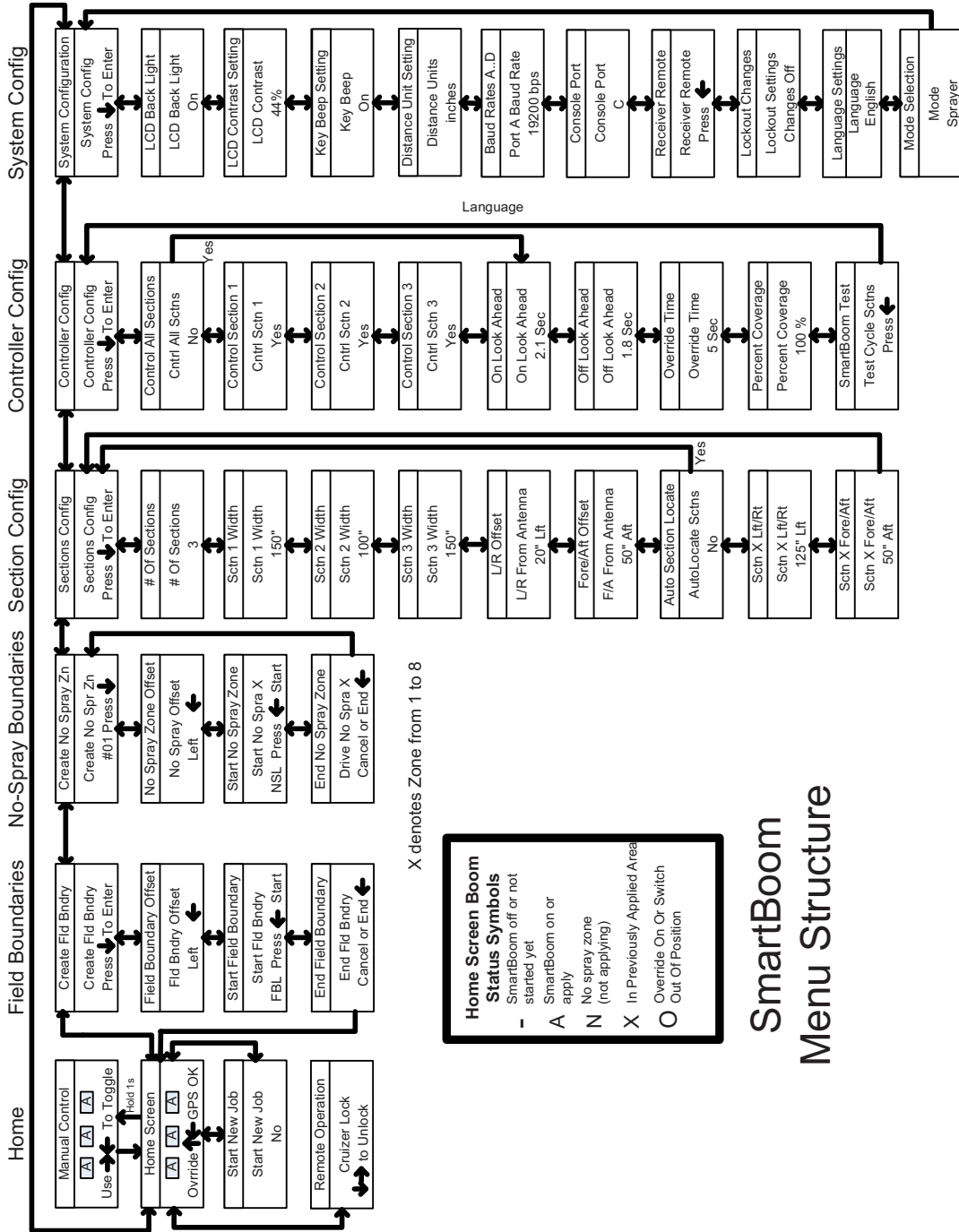

SmartBoom Menu Structure

The following are different screens and settings used by the front panel display.



Home Display Screen

Raven recommends that you use this screen during normal SmartBoom/SmartRow operation.

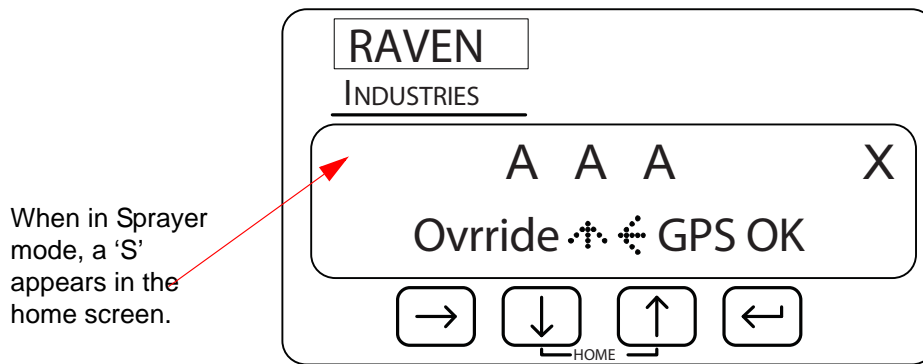
If SmartBoom/SmartRow is operating under normal operation without warnings, the Front Panel display will look similar to this:



When in Sprayer mode, a 'S' appears in the home screen.

Note: You can return to the Home screen anytime by pressing the  and  keys at the same time.

The X in the upper right of the display indicates that the Master Switch is in the Off position. When the Master Switch is toggled On, this X will be replaced with a check mark. See also the System Configuration Menu section in Chapter 5 for information on the Master Switch feature.

Note: SmartBoom/SmartRow will not control any boom sections unless a check mark is displayed in the upper right corner of the Home screen.

Manual Control Screen



The Manual Control Screen allows you to manually toggle the booms to their opposite state with few key presses.



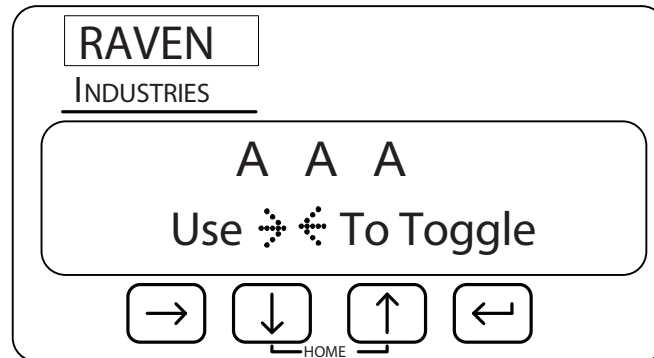

From the Home screen, press and hold  to access Manual Control. The Manual Control screen should look something like the example below when you first enter it.



Left Boom Control

Left Boom Control: Pressing the  key will toggle the far left boom. Subsequent presses of the  key will toggle the next boom in from the left. Subsequent presses of the  key will re-enable automatic control of each boom moving back toward the far left boom.



Right Boom Control

Right Boom Control: Pressing the  key after entering the Manual Control screen will toggle the far right boom. Subsequent presses of the  key will toggle the next boom in from the right. Subsequent presses of the  key will re-enable automatic control of each boom moving back toward the far right boom.

Manual Control When Stopped

Any booms placed under manual control while the vehicle is not in motion will be forced OFF when you start moving.

Returning Home

Press  or  to return to the home screen and place all booms back under automatic control.



Field Boundary Menu

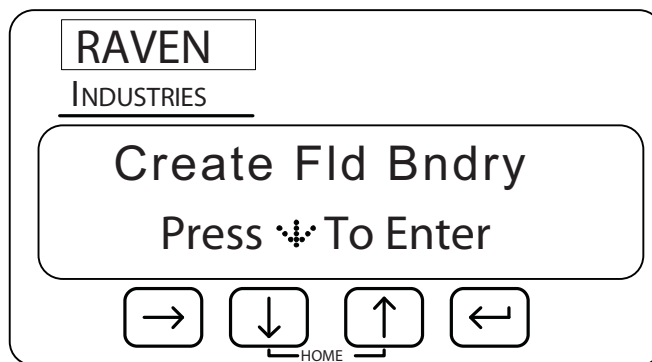

To get to the Field Boundary Menu from the Home screen, press  until “Create Fld Bndry” is displayed:



The Create Field Boundary screens allow you to set up SmartBoom/SmartRow to create or replace a no spray field boundary while you are applying your first pass around the field. The following screens are available from the Field Boundary menu:

- Field Boundary Offset Screen
- Start Field Boundary Screen
- End Field Boundary Screen

You can navigate to the different screens under the Create Fld Bndry screen by pressing either the  or  key. For example, you can set up the Fld Bndry Offset by pressing  from the Create Fld Bndry screen.

Note: You can return to the Home Screen anytime by pressing the  and  keys at the same time.





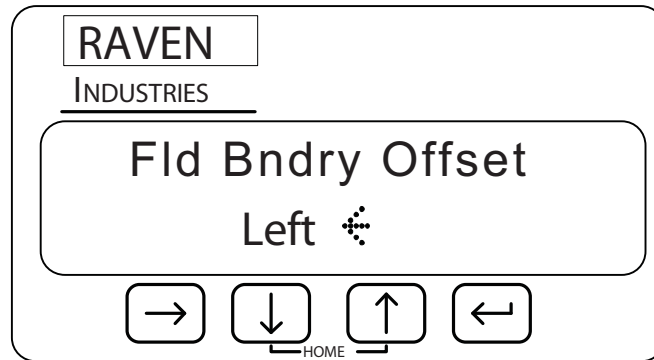

Field Boundary Offset Screen

To get to the Fld Bndry Offset screen, press  from the Create Fld Bndry screen.

The Fld Bndry Offset screen displays the orientation of the field boundary with respect to the booms. If "Left" is selected, the field boundary will be created at the end of the left boom. If "Right" is selected, the field boundary will be created at the end of the right boom. If "Center" is selected, the boundary will be created at the center of the booms.





Press  to edit the offset. The menu will begin blinking. Use the  or  key to toggle between selections. Press  to apply your selection.

Start Field Boundary Screen

To get to the Start Fld Bndry screen press  from the Fld Bndry Offset screen.

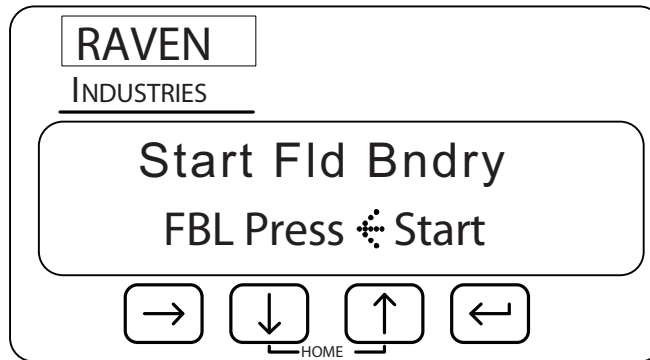
The lower left corner of the Start Fld Bndry screen shows the orientation of the field boundary with respect to the spray booms. "FBL" indicates the end of the left boom will be used. "FBR" indicates the end of the right boom will be used. Make sure you have selected the correct Field Boundary Offset for the direction you will be traveling around the field.



Press  to begin recording the field boundary.

End Field Boundary Screen

The End Fld Bndry screen will automatically display after you have pressed  on the Start Fld Bndry screen.

Note: *If you do not come back to the starting point before you end the field boundary, SmartBoom/SmartRow will close the field boundary by generating a line from the starting point to the machine's current location. The area equal to three boom widths outside of the field boundary will become a no spray zone.*

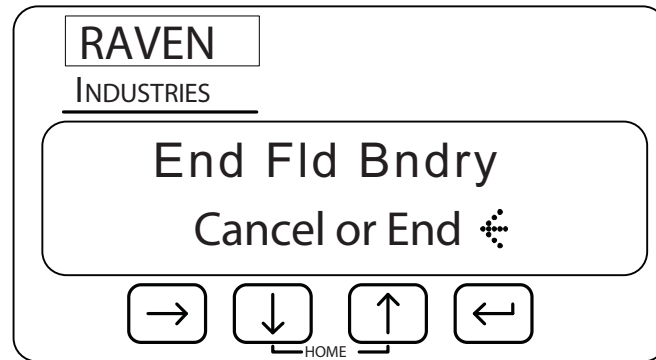

The End Fld Bndry screen allows you to mark the end of the field boundary or cancel the operation. Press to complete the recording of the field boundary. The display will blink “End.” Use the or key to toggle between “End” and “Cancel.” Press the key again to apply your selection.



No Spray Zone Menu



To get to the Create No Spray Zone Menu from the Home screen, press until “Create No Spr Zn” is displayed:



The No Spray Zone screens allow you to define up to eight areas that you do not want sprayed. The following screens are available from the No Spray Zone menu:

- No Spray Zone Offset
- Start No Spray Zone
- End No Spray Zone

You can navigate to the different screens under the Create No Spr Zn screen by pressing either the  or  key. For example, you can set up the No Spray Offset by pressing  from the Create No Spr Zn screen.





Note: You can return to the home screen anytime by pressing the  and  keys at the same time.

No Spray Zone Offset Screen

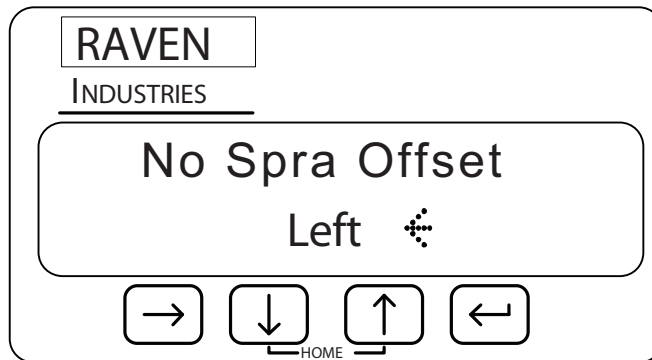
To get to No Spr Offset screen press  from the last Create No Spr Zn screen.

The No Spray Offset screen displays the orientation of the no spray zone with respect to the booms. If “Left” is selected, then the no spray zone will be created at the end of the left boom. If “Right” is selected, then the no spray zone will be created at the end of the right boom. If “Center” is selected then the no spray zone will be created at the center of the booms.



Press  to edit the offset. The display will begin blinking. Use the  or  key to toggle between selections. Press the  key again to apply your selection.

Start No Spray Zone Screen

To get to the Start No Spr 1 screen press  from the No Spray Offset screen.

The lower left hand corner of the Start No Spr 1 screen shows the orientation of the no spray zone with respect to the spray booms. “NSL” indicates the end of the left boom will be used. “NSR” indicates



the end of the right boom will be used. Make sure you have selected the correct No Spray Offset for the direction you will be traveling around the no spray zone.

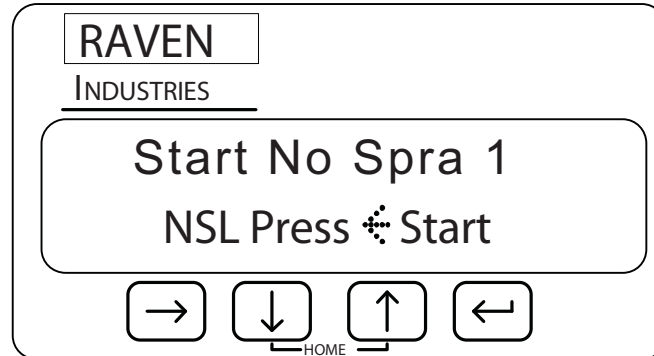

Press [left arrow] to begin recording the no spray zone.



Note: A maximum of eight no spray zones can be created for a job. The Start No Spray Zone screen will automatically advance to the next zone number after each no spray zone has been ended.

End No Spray Zone Screen

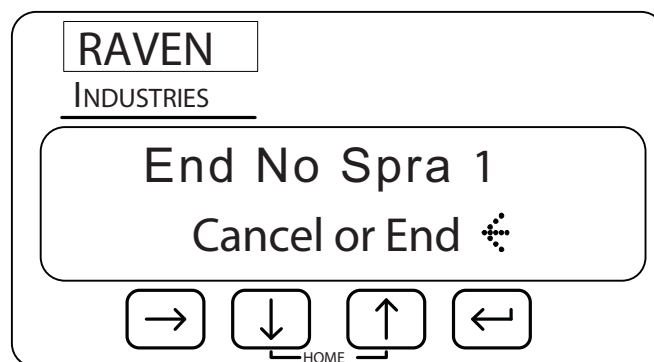
The End No Spr 1 screen will automatically display after you have pressed the [left arrow] key on the Start No Spr 1 screen.



The End No Spray Zone screen allows you to mark the end of the no spray zone or cancel the operation. Press [left arrow] to complete the recording of the no spray zone. The display will blink "End." Use

the  or  key to toggle between “End” and “Cancel.” Press the  key again to apply your selection.

Note: *If you do not come back to the starting point before you end a no spray zone, SmartBoom/ SmartRow will close the no spray zone by generating a line from the starting point to the machine’s current location. The area inside this boundary will become a no spray zone.*

Initial Startup

Before beginning your first application, you need to install and configure SmartRow for your planter. Refer to the following points to set up SmartRow. This ensures that SmartRow is configured for the specific equipment with which it will be operating.

1. Set up the GPS System - Refer to your GPS receiver operator's manual to set up your GPS receiver to output a GPS signal to SmartRow. SmartRow requires both GGA position and VTG speed messages from the receiver. Message output rates should be at least 4 Hz. An output rate of 10 Hz is recommended.
2. Select the Planter mode (either electric or pneumatic (air) clutch) from the System Config menu.
3. Select Distance Units - Use the SmartRow Section Configuration Menus to set up the units that SmartRow will use to measure. You can select inches or centimeters.
4. Configure The Sections Widths - Use the SmartRow Sections Configuration Menus to set up the number of section and the width of each section.
5. Orient the implement with respect to the GPS antenna - Use the SmartRow Sections Configuration Menus to enter the location of the center of the implement with respect to the GPS Antenna.

6. Configure the Implement Locations - If this is a standard configuration, use the SmartRow Autoloaded feature to configure the location of each section with respect to the GPS antenna. If a custom configuration is used, use the optional section configuration screens to set the location of each section with respect to the GPS Antenna.

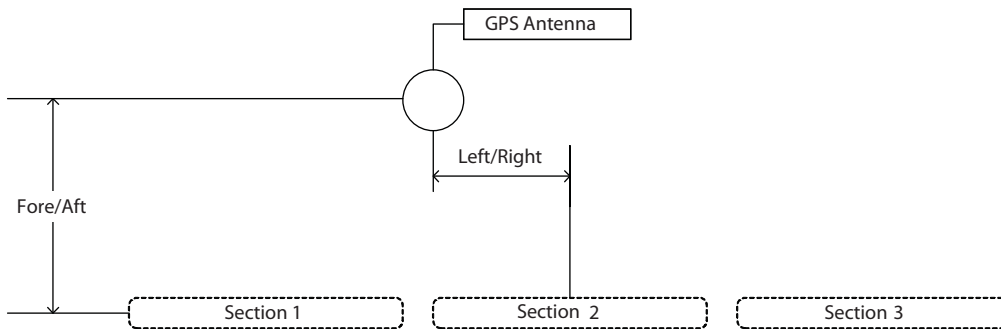

FIGURE 1. Section Location Example





7. Set the Look Ahead Times - Use the SmartRow Configuration menus to set the Turn On and Turn Off Look Ahead Times. The default setting is 0.1 seconds.
8. Set the Override Time - Use the SmartRow Configuration menus to set the Override Time. The default setting is 5 seconds.
9. Set the Percent Coverage - Use the SmartRow Configuration menus to set the Percentage Coverage. The default setting is 100 percent.
10. Select The Sections To Be Controlled - Use the SmartRow Configuration menus to select which sections will be controlled by SmartRow. The default setting allows SmartRow to control all sections.

About SmartRow Jobs

SmartRow provides several methods of operation. These include:

- Standard Job
- Job With Field Boundary
- Job With No Plant Zones
- Job With Field Boundary And No Plant Zones

Standard SmartRow Job

The simplest way to use SmartRow is to start a job and begin planting. From the Home screen, press  to display the Start New Job screen. Use the  or  key to toggle between yes or no. Select “Yes”. Then, press  to lock in your selection and to start a new job. SmartRow will generate an as-applied map of spray activity. If you enter an area that has already been sprayed, SmartRow automatically turns off the sections that have entered the previously planted area.

SmartRow will generate an as-applied map of plant activity. If you enter an area that has already been planted, SmartRow will automatically turn off the sections that have entered the previously planted area.

SmartRow Job with Field Boundary

If you are concerned about not applying any product outside of a field, you can create a no plant field boundary when you start a job. Use the Create Field Boundary feature during an initial pass around a field and SmartRow monitors the location of the sections to create a field boundary. Once the field boundary is created, SmartRow will automatically create a no plant zone of at least three implement widths around the field. During the rest of your application, SmartRow will turn off any sections that enter the no plant zone outside the field boundary.

SmartRow Job with No Plant Zones

Some fields have features that you do not want to plant like waterways or well heads. SmartRow allows you to create up to eight no plant zones within a job. Simply select the No Plant Zone Boundary Menus and follow the instructions. Once you have told SmartRow that you want to create a no plant zone, you can continue to plant while you drive around the area on which you do not want to apply product. SmartRow will create a no plant zone within the area you have planted around. During the rest of your application, SmartRow will turn off any sections that enter this no plant zone.

SmartRow Job with Field Boundary and No Plant Zones

For complete SmartRow control, you can generate both a field boundary and up to eight no plant zones for a job. Simply use the field boundary and no plant zone menus on the SmartRow and plant around the areas you do not want to plant. SmartRow will create an as-applied map which includes a no plant field boundary and up to eight no plant zones within the field boundary.

Additional SmartRow Features

SmartRow provides additional features to permit optimum coverage capabilities for your specific application. These features include:

- Look Ahead
- Percent Coverage
- Override

Look Ahead



SmartRow allows you to pre-program Turn-On and Turn-Off Look Ahead times. SmartRow monitors the GPS position and as-applied map while considering the Look Ahead times to begin turning sections on or off before they cross plant or no plant boundaries. Look Ahead times can help compensate for delays in the planter system including the time it takes for planter clutches to open and close. The specific Look Ahead time is a function of the valve timing and the speed at which the operator is driving the machine.

Percent Coverage

SmartRow provides the ability to pre-define the amount of coverage SmartRow will apply. For most applications that require complete coverage, the Percent Coverage should be set to 100 percent. For applications that will not tolerate overlap, the Percent Coverage should be set to a lower value.

SmartRow allows a Percent Coverage value anywhere from 5 to 100 percent in increments of 5 percent.

SmartRow Override

SmartRow provides you the ability to momentarily override the SmartRow feature and force all sections on. This may be desired if you want to double up coverage on an area of the field. The override feature is also used when starting off from a dead stop. Enable the SmartRow Override feature and disengage the clutch to begin planting before driving ahead. The amount of time for the override can be modified from the Configuration menu. See “Override Time Screen” on page 59. From the Home screen, touch  and  at the same time to enable the SmartRow Override feature.

Note: *When the override feature is enabled, an “O” appears in the Home screen.*

Manual Control

SmartRow provides you with the ability to manually toggle individual sections on or off. Manual Control is useful in situations when parts of a section will overlap other crop areas.

CHAPTER

7

SmartRow Front Panel Display

Display Setup

Gently peel away the protective film covering the Front Panel. The Front Panel display allows the user to configure the vehicles section settings, SmartRow control and settings, and to run a job with or without a field boundary and no plant zones. The keypad arrows are used to navigate through the display and configuration menus.

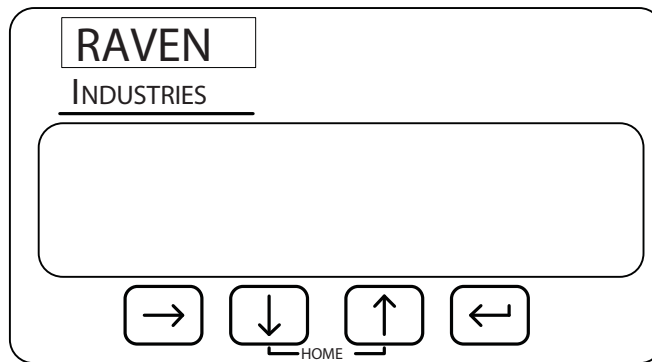

SmartRow Menu Structure

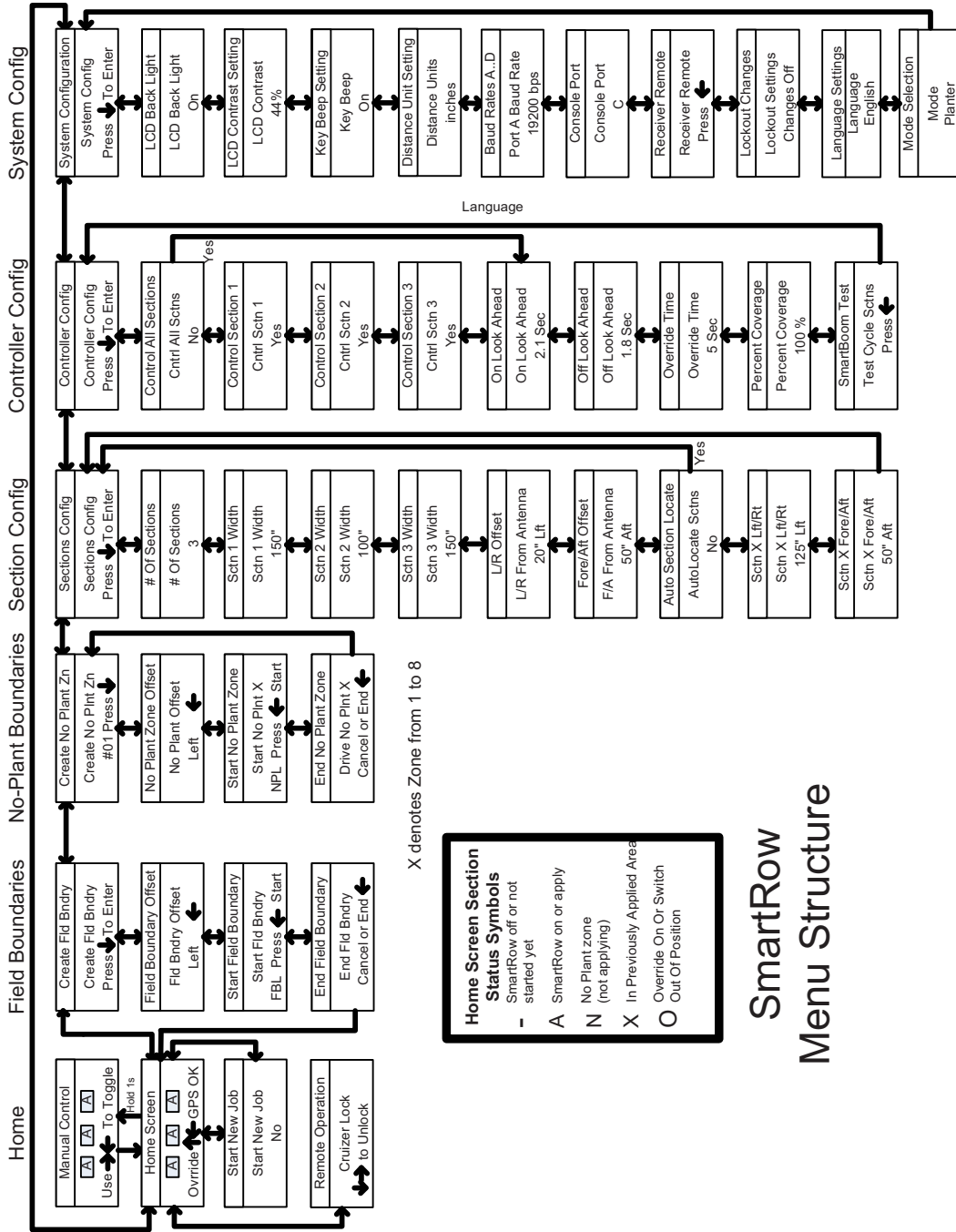

SmartRow Menu Structure

The following are different screens and settings used by the front panel display.

Home Display Screen

Raven recommends that you use this screen during normal SmartRow operation.

If SmartRow is operating under normal operation without warnings, the Front Panel display will look similar to this:

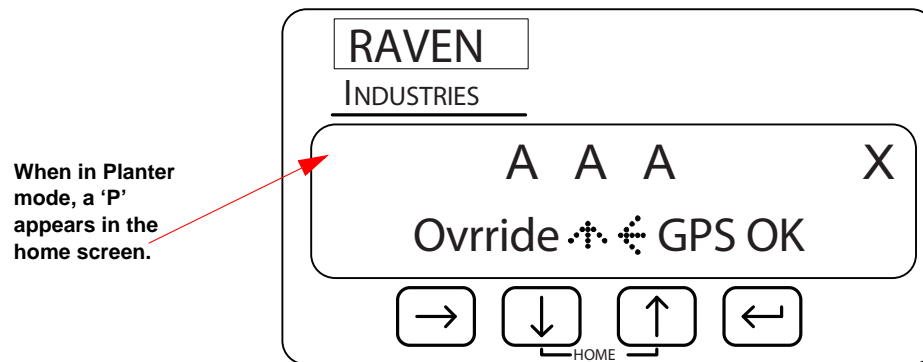

Note: You can return to the Home Screen anytime by pressing the and keys at the same time.

The X in the upper right of the display indicates that the Master Switch is in the Off position. When the Master Switch is toggled On, this X will be replaced with a check mark. See also the Sections Configuration Menu section in Chapter 8 for information on the Master Switch feature.

Note: SmartRow will not control any planter sections unless a check mark is displayed in the upper right corner of the Home screen.



Manual Control Screen

The Manual Control Screen allows you to manually toggle the to their opposite state with few key presses.

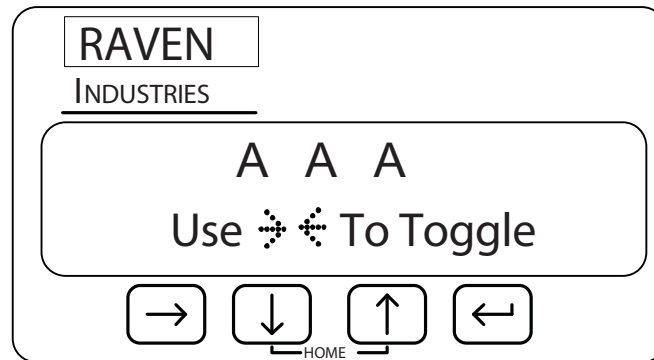

From the Home screen, press and hold  to access Manual Control. The Manual Control screen should look something like the example below when you first enter it.



Left Section Control

Left Section Control: Pressing the  key will toggle the far left section. Subsequent presses of the  key will toggle the next section in from the left. Subsequent presses of the  key will re-enable automatic control of each section moving back toward the far left section.



Right Section Control

Right Section Control: Pressing the  key after entering the Manual Control screen will toggle the far right section. Subsequent presses of the  key will toggle the next section in from the right. Subsequent presses of the  key will re-enable automatic control of each section moving back toward the far right section.

Manual Control When Stopped

Any sections placed under manual control while the vehicle is not in motion will be forced OFF when you start moving.

Returning Home

Press  or  to return to the Home screen and place all sections back under automatic control.



Field Boundary Menu

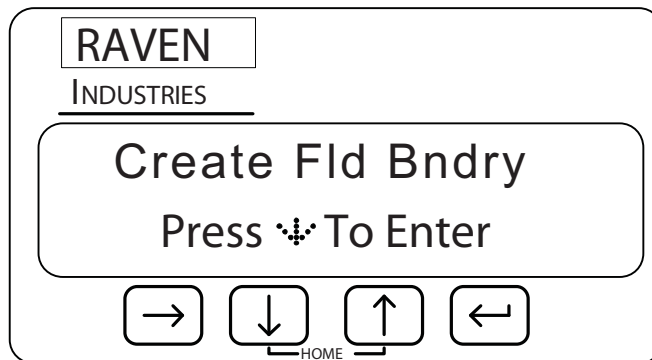

To get to the Field Boundary Menu from the Home screen, press  until “Create Fld Bndry” is displayed:



The Create Field Boundary screens allow you to set up SmartRow to create or replace a no plant field boundary while you are applying your first pass around the field. The following screens are available from the Field Boundary menu:

- Field Boundary Offset screen
- Start Field Boundary screen
- End Field Boundary screen

You can navigate to the different screens under the Create Fld Bndry screen by pressing either the  or  key. For example, you can set up the Fld Bndry Offset by pressing  from the Create Fld Bndry screen.





Note: You can return to the Home Screen anytime by pressing the  and  keys at the same time.

Field Boundary Offset Screen

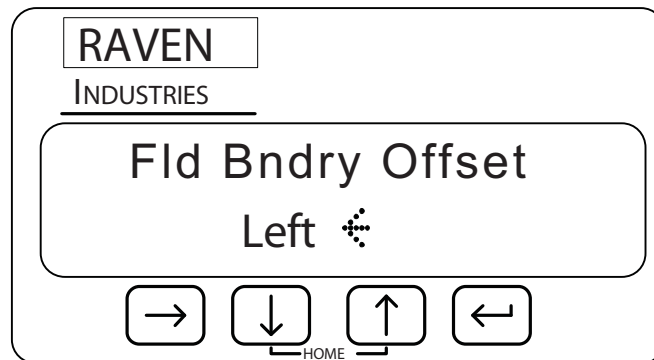
To get to the Fld Bndry Offset screen, press  from the Create Fld Bndry screen.

The Fld Bndry Offset screen displays the orientation of the field boundary with respect to the sections. If "Left" is selected, the field boundary will be created at the end of the left section. If "Right" is selected, the field boundary will be created at the end of the right section. If "Center" is selected, the boundary will be created at the center of the sections.



Press  to edit the offset. The menu will begin blinking. Use the  or  key to toggle between selections. Press  to apply your selection.

Start Field Boundary Screen

To get to the Start Fld Bndry screen press  from the Fld Bndry Offset screen.

The lower left corner of the Start Fld Bndry screen shows the orientation of the field boundary with respect to the planter sections. "FBL" indicates the end of the left section will be used. "FBR" indicates the end of the right sections will be used. Make sure you have selected the correct Field Boundary Offset for the direction you will be traveling around the field.

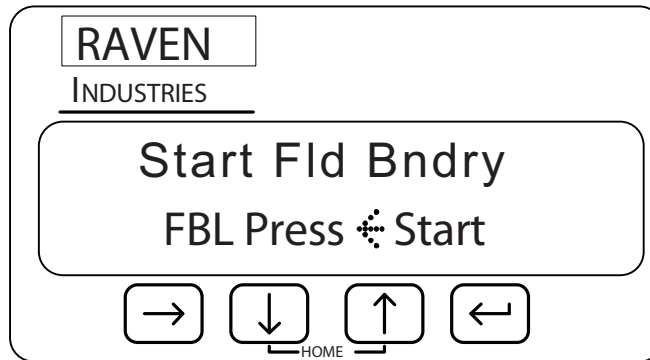





Press  to begin recording the field boundary.

End Field Boundary Screen

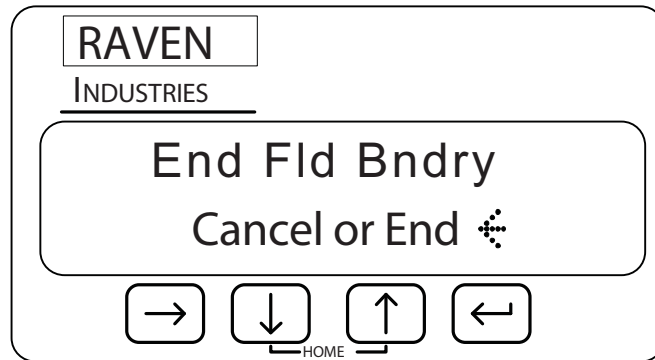
The End Fld Bndry screen will automatically display after you have pressed  on the Start Fld Bndry screen.

Note: *If you do not come back to the starting point before you end the field boundary, SmartRow will close the field boundary by generating a line from the starting point to the machine's current location. The area equal to three Implement widths outside of the field boundary will become a no plant zone.*



The End Fld Bndry screen allows you to mark the end of the field boundary or cancel the operation. Press  to complete the recording of the field boundary. The display will blink “End.” Use the  or  key to toggle between “End” and “Cancel.” Press the  key again to apply your selection.



No Plant Zone Menu

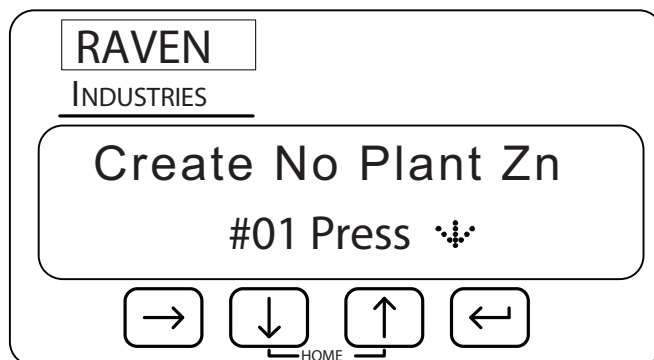

To get to the Create No Plant Zone Menu from the Home screen, press  until Create No Plant Zn is displayed:



The No Plant Zone screens allow you to define up to eight areas that you do not want planted. The following screens are available from the No Plant Zone menu:

- No Plant Zone Offset
- Start No Plant Zone
- End No Plant Zone

You can navigate to the different screens under the Create No Plant Zn screen by pressing either the  or  key. For example, you can set up the No Plant Offset by pressing  from the Create No Plant Zn screen.





Note: You can return to the Home Screen anytime by pressing the  and  keys at the same time.

No Plant Zone Offset Screen

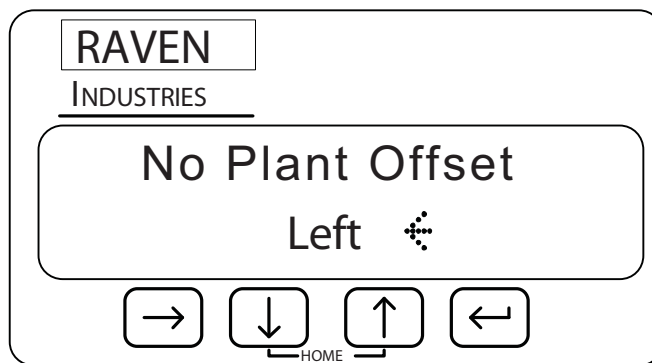
To get to No Plant Offset screen press  from the last Create No Plant Zn screen.

The No Plant Offset screen displays the orientation of the No Plant Zone with respect to the implement. If “Left” is selected, then the no plant zone will be created at the end of the left section. If “Right” is selected, then the no plant zone will be created at the end of the right section. If “Center” is selected then the no plant zone will be created at the center of the sections.



Press  to edit the offset. The display will begin blinking. Use the  or  key to toggle between selections. Press the  key again to apply your selection.

Start No Plant Zone Screen

To get to the Start No Plant 1 screen press  from the No Plant Offset screen.

The lower left hand corner of the Start No Plant 1 screen shows the orientation of the no plant zone with respect to the planter section. “NPR” indicates the end of the left boom will be used. “NPL”

indicates the end of the right section will be used. Make sure you have selected the correct no plant offset for the direction you will be traveling around the no plant zone.

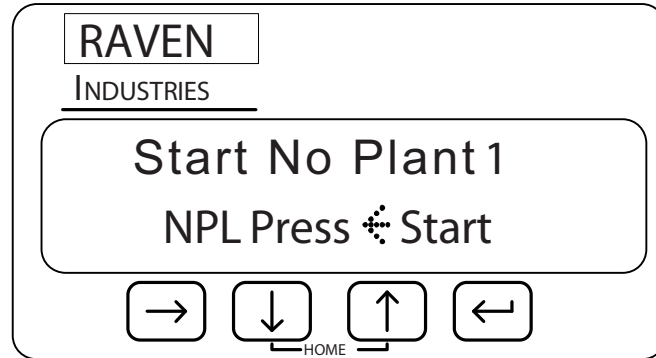





Press  to begin recording the no plant zone.

Note: *A maximum of eight no plant zones can be created for a job. The Start No Plant Zone screen will automatically advance to the next zone number after each no plant zone has been ended.*

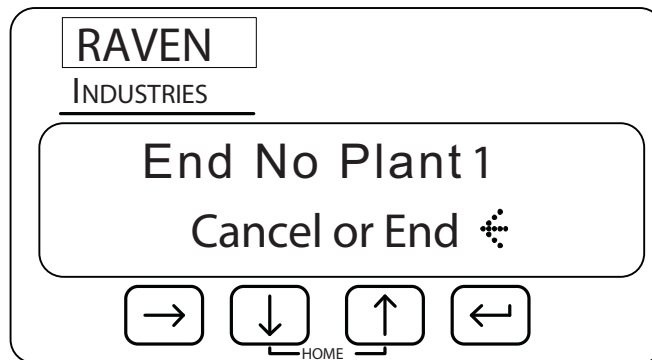

End No Plant Zone Screen

The End No Plant 1 screen will automatically display after you have pressed the  key on the Start No Spr 1 screen.



The End No Plant Zone screen allows you to mark the end of the no plant zone or cancel the operation. Press  to complete the recording of the no plant zone. The display will blink "End." Use the  or  key to toggle between "End" and "Cancel." Press the  key again to apply your selection.





Note: *If you do not come back to the starting point before you end a no plant zone, SmartRow will close the no plant zone by generating a line from the starting point to the machine's current location. The area inside this boundary will become a no plant zone.*

Note: You can return to the Home Screen anytime by pressing the  and  keys at the same time.

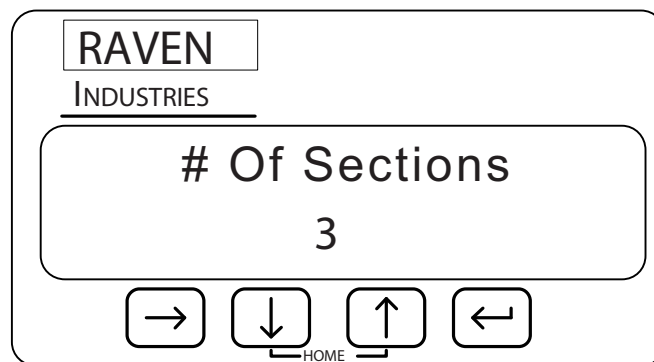
Number of Sections Screen

To get to the # Of Sections screen press  from the System Configuration screen.



Press  to edit the number of booms. The number will begin blinking to indicate you are in edit mode. Use the  or  key to increase or decrease the number of booms/Rows displayed. Press the  key again to finish editing.





Note: SmartBoom/SmartRow will only display options for Section Width, Individual Offset (L/R and F/A), and Individual Control sections screens according to the value programmed on this screen.

Section Width Screens

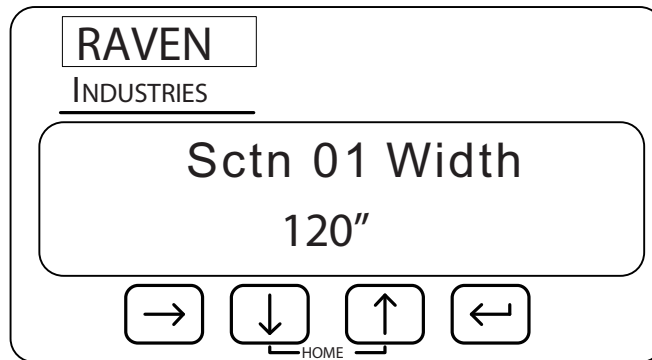
To get to the Section Width screens press  from the # Of Sections screen.

The Section Width screens display the width in inches or centimeters for each boom section. This number should equal the width of the corresponding numbered boom of the sprayer on which SmartBoom/SmartRow is installed. See the System Configuration section later in this chapter for more information on configuring the Distance Units your SmartBoom/SmartRow controller will display.



Press  to edit the section width. The number will begin blinking to indicate you are in edit mode. Use the  or  key to increase or decrease the value representing the width of the current boom section. Use  to move between digits. Press the  key again to finish editing.





Note: *Continue pressing to wrap the cursor back around to the most significant digit.*

Press  from the Sctn 1 Width screen to access the Sctn Width for section 2-10. The actual number of section width screens will depend upon the number of sections programmed on the # Of Sections screen.

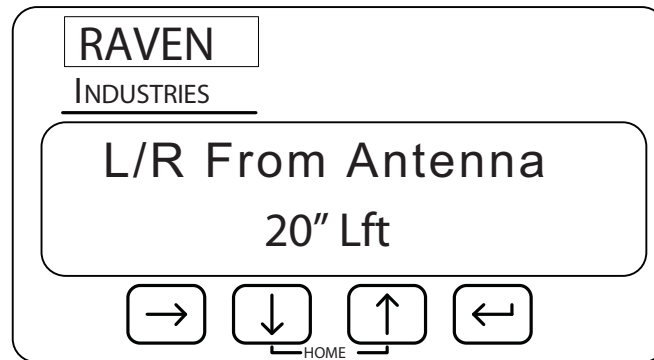
L/R Offset Screen

To get to the L/R Offset screen press  from the last Section Width screen. The L/R Offset screen sets the left or right offset of the center of the implement with respect to the GPS antenna.







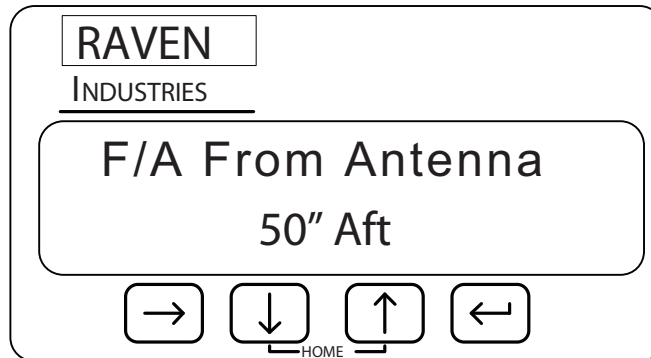

Press  to edit the L/R Offset. The number will begin blinking to indicate you are in edit mode. Use the  or  key to increase or decrease the value representing the offset of the center of the boom. Use the  key to move between digits and Lft/Rt selection. Press the  key again to finish editing.

Note: Continue pressing  to wrap the cursor back around to the most significant digit.

F/A Offset Screen

To get to the F/A Offset screen press  from the L/R Offset screen. The F/A Offset screen displays the location of the implement in front of (Fore) or behind (Aft) of the GPS antenna.



Press  to edit the F/A Offset. The number will begin blinking to indicate you are in edit mode. Use the  or  key to increase or decrease the number displayed. Use the  key to move between digits and Fore/Aft selection. Press the  key again to finish editing.

Note: Continue pressing  to wrap the cursor back around to the most significant digit.



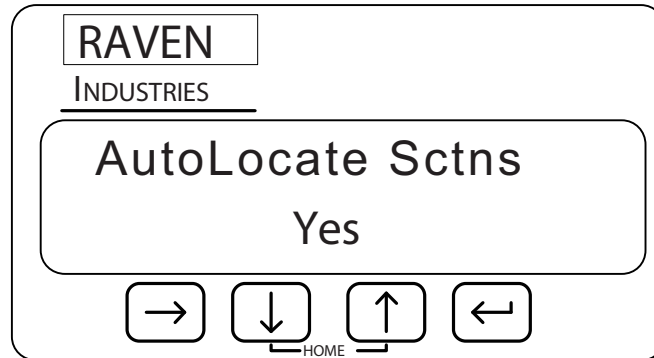

Autolocate Sections Screen

To get to the AutoLocate Sctns screen press  from the last F/A Offset screen.

The AutoLocate Sctns screen allows you to automatically set up the location of all sections with respect to the GPS Antenna.



Note: *The AutoLocate Sctns feature assumes that all sections will be located end to end with no overlap or skip. If you have a special application where one or more sections are staggered or overlap each other, do not use this feature.*





Press  to edit the AutoLocate Sctns setting. The display will begin blinking to indicate you are in edit mode. Use the  or  key to toggle between “Yes” and “No.” Press the  key again to finish editing.

Individual L/R Offset Screen

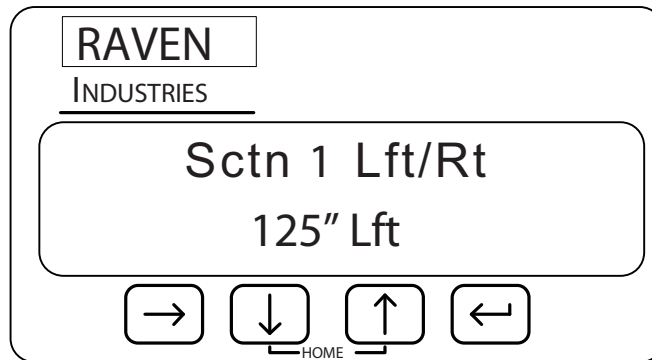
The Individual L/R Offset screen sets the left or right offset of the center of the section with respect to the GPS antenna.

Press  from the AutoLocate Sctn screen to get to the Sctn 1 Lft/Rt Offset screen. The Sctn 1 Lft/Rt screen displays the left or right location of the center implement number 1 with respect to the center of the GPS antenna.



Press  to edit the L/R Offset. The number will begin blinking to indicate you are in edit mode. Use the  or  key to increase or decrease the Left or Right value representing the boom section offset. Use the  key to move between digits and Lft/Rt selection. Press the  key again to finish editing.

Note: Continue pressing  to wrap the cursor back around to the most significant digit.

Press  to edit the Individual L/R Offset for sections 2-10. The actual number of Sctn L/R Offset screens will depend upon the number of sections programmed on the # Of sections screen.





Individual Fore/Aft Offset Screen

To get to the Sctn 1 F/A Offset screen, press  from the last Sctn L/R Offset screen.

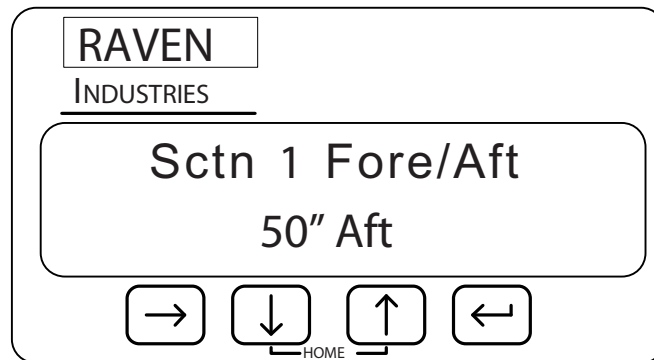
Note: *These screens will only appear if “No” is selected on the AutoLocate Sctns screen.*

The Sctn 1 F/A Offset screen displays the distance section number 1 is located in front of (fore) or behind (aft) of the center of the GPS Antenna.



Press  key to edit the L/R Sctn Offset. The number will begin blinking to indicate you are in edit mode. Use the  or  key to increase or decrease the value representing the Fore/Aft offset of the section. Use the  key to move between digits and Fore/Aft selection. Press the  key again to finish editing.

Note: *Continue pressing  to wrap the cursor back around to the most significant digit.*

Press  to edit the Individual F/A Offset for sections 2-10. The actual number of Sctn Fore/Aft Offset screens will depend upon the number of sections programmed on the # Of sctn screen.



Controller Configuration Menu

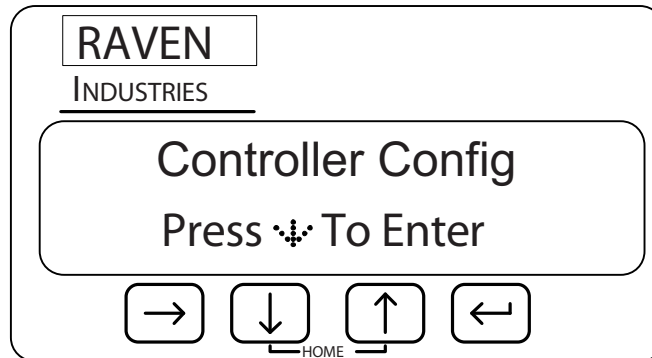

To get to the Controller Config Menu from the Home screen, press  until “Controller Config” is displayed:



The Controller Configuration screens allow you to set up SmartBoom/SmartRow control parameters for the job you are working on. Under most conditions, these settings will be set and not changed. The following screens are available from the SmartBoom/SmartRow Configuration menu:

- Control All Sections Screen
- Control Individual Sections Screens
- On Look Ahead Screen
- Off Look Ahead Screen
- Override Time Screen
- Percent Coverage Screen
- Test Cycle Sections Screen





You can navigate to the different screens under the SmartBoom/SmartRow Configuration screen by pressing either the  or  key. For example, you can display the Control All Sctns screen by pressing the  key from the SmartBoom/SmartRow Configuration screen.

Note: You can return to the Home Screen anytime by pressing the  and  keys at the same time.

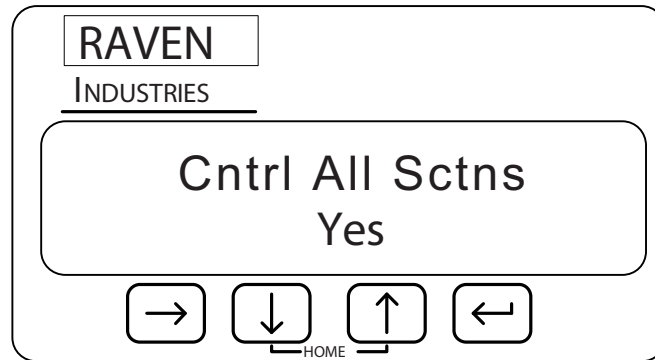
Control All Sctns Screen

To get to the Control All Sctns screen press  from the Config screen.







Press  to edit the Cntrl All Sctns setting. The setting will begin blinking to indicate you are in edit mode. Use the  or  key to toggle between “Yes” and “No.” Press the  key again to finish editing.

Control Section Screens

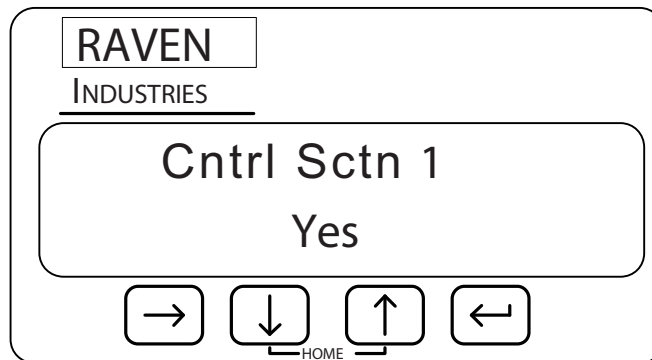
The Control Section 1 screen will appear automatically if No is selected on the Control All Section screen.

The Control Section 1 screen allows you to individually enable SmartBoom/SmartRow control for section number 1.



Press  to edit the Cntrl Sctn 1 setting. The setting will begin blinking to indicate you are in edit mode. Use the  or  key to toggle between “Yes” and “No.” Press the  key again to finish editing.





Press  to edit the Control Sctn feature for booms 2-10. The actual number of Cntrl sctn screens will depend upon the number of sections programmed on the # of Sections screen.

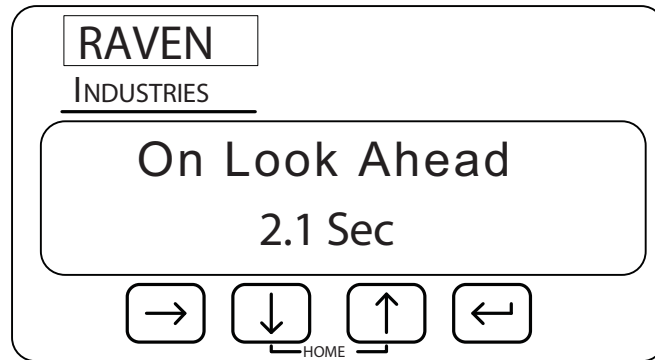

On Look Ahead Screen

To get to the On Look Ahead screen, press  from the Controller Config screen.







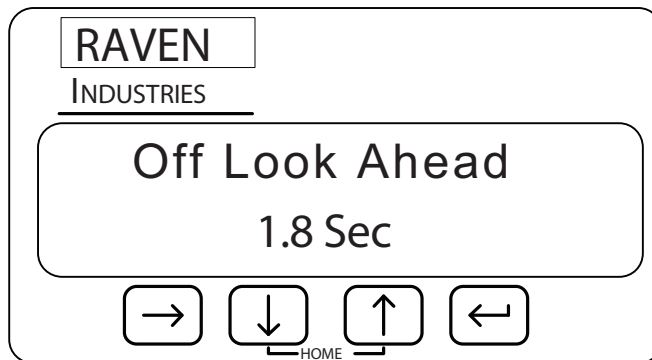

Press  to edit the On Look Ahead setting. The number will begin blinking to indicate you are in edit mode. Use the  or  key to increase or decrease the value displayed. Use  to move between digits. Press the  key again to finish editing.

Note: *If you select No in the Cntrl All Sctns screen and step through the individual Cntrl screens, you will automatically come to the On Look Ahead screen when you press  from the last Cntrl sctns screen.*

Off Look Ahead Screen

To get to the Off Look Ahead screen press  from the On Look Ahead screen.







Press  to edit the Off Look Ahead setting. The number will begin blinking to indicate you are in edit mode. Use the  or  key to increase or decrease the value displayed. Use  to move between digits. Press the  key again to finish editing.

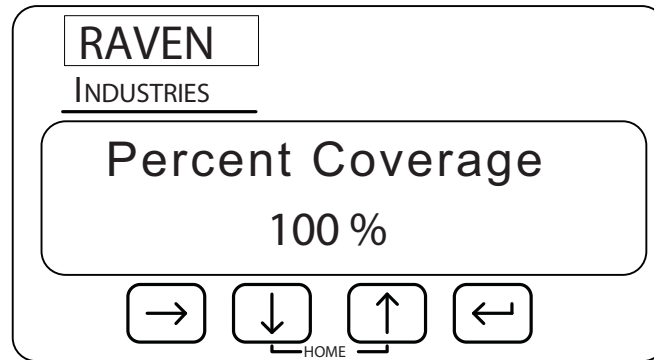

Percent Coverage Screen

To get to the Percent Coverage screen, press  from the Off Look Ahead screen.





Press the  key to edit the Percent Coverage setting. The number will begin blinking to indicate you are in edit mode. Use the  or  key to increase or decrease the setting in 5% increments. Press  again to finish editing.



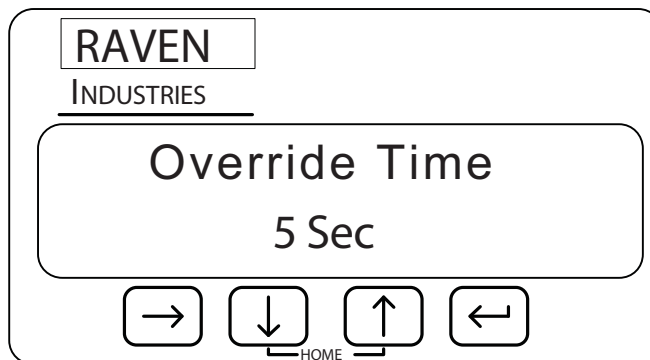

Override Time Screen

To get to the Override Time screen, press  from the Percent Coverage screen.

The Override Time screen displays the amount of time, in seconds, that the booms will be turned on and override the SmartBoom/SmartRow feature. This feature is most often used when starting from a full stop position or to reapply over a previously sprayed area.



Press  to edit the Override Time. The number will begin blinking to indicate you are in edit mode.

Use the  or  key to increase or decrease the number displayed. Use the  key to move between digits. Press the  key again to finish editing.



Test Cycle Sections Screen

To get to the Test Cycle Sctns screen, press  from the Override Time screen.

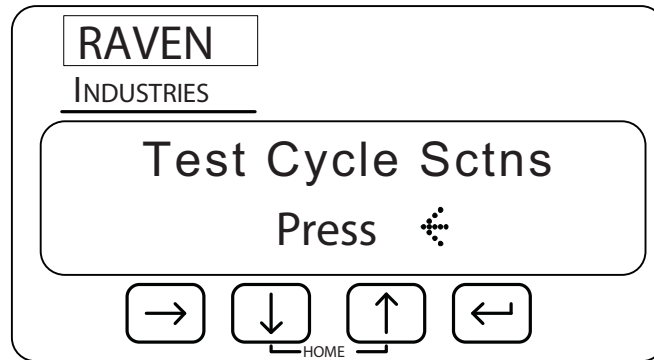

To test cycle the sections, press  from the Test Cycle Sectns screen. Each section will individually turn on for 4 seconds and then turn off. The next section will then be turned on and off and the process will continue until every sections has been cycled on and off. Do not navigate to away from the Test Cycle Sctns screen until the process is finished.



System Configuration Menu

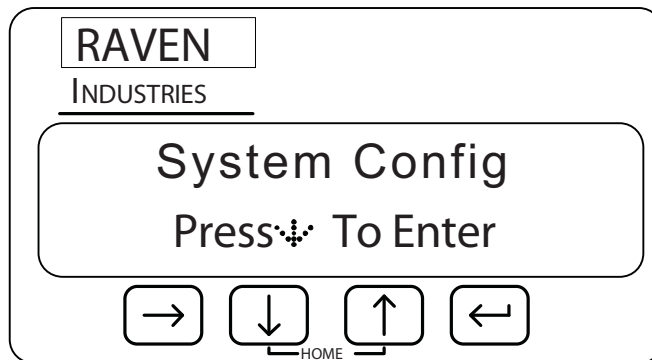

To get to the System Config Menu from the Home screen, press  until "System Config" is displayed:



The System Configuration screens allow you to adjust system settings, such as lighting and unit measurement display. The following screens are available from the System Configuration menu:

- LCD backlight Setting
- LCD Contrast Setting
- Distance Units Setting
- Key Beep Setting
- Baud Rate Setting
- Console Port Setting
- Master Switch Setting
- Receiver Remote Front Panel Access
- Lockout Setting Changes
- Language Setting
- Mode Selection





You can navigate to the different screens under the System Config screen by pressing either the  or  key. For example, you can display the LCD Back Light screen by pressing  from the System Config screen.

Note: You can return to the Home Screen anytime by pressing the  and  keys at the same time.

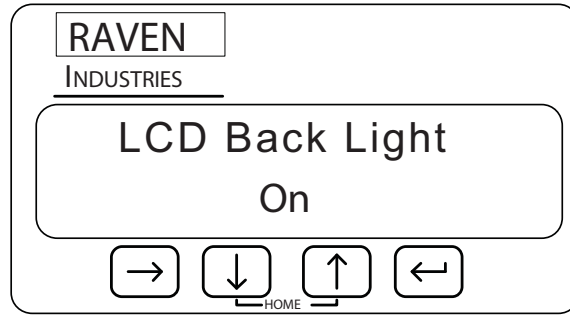
LCD Backlight Screen

To get to the LCD Backlight screen press  from the System Config screen.





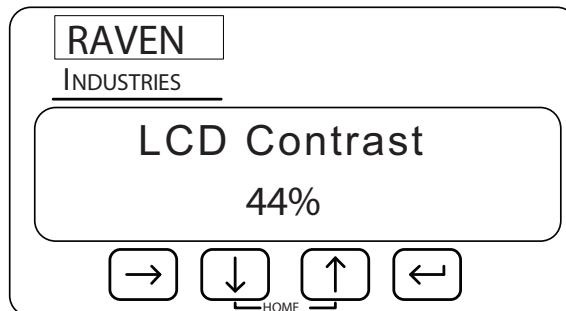

Press  to edit the LCD Back Light setting. The setting will begin blinking to indicate you are in edit mode. Use the  or  key to toggle between “On” and “Off.” Press the  key again to finish editing.

LCD Contrast Screen

To get to the LCD Contrast screen press  from the LCD Backlight screen.







Press  to edit the LCD Contrast. The number will begin blinking to indicate you are in edit mode. Use the  or  key to increase or decrease the number displayed. Press the  key again to finish editing.

Note: Continue pressing  to wrap the cursor back around to the most significant digit.

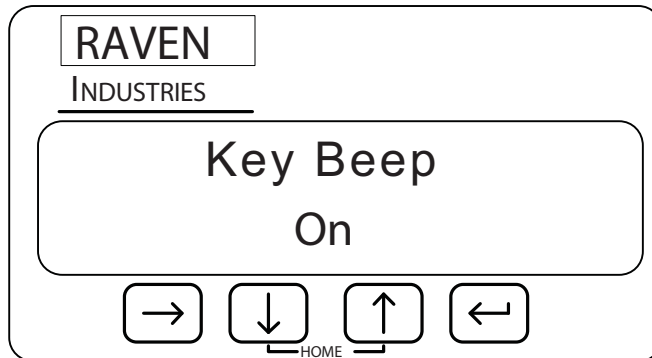
Key Beep Screen

To get to the Key Beep screen press  from the LCD Contrast screen. The Key Beep Setting screen allows you to enable or disable key beeps and audible alarms.



Press  to edit the Key Beep setting. The setting will begin blinking to indicate you are in edit mode. Use the  or  key to toggle between "On" and "Off." Press the  key again to finish editing.





Distance Unit Screen

To get to the Distance Unit screen press  from the Key Beep screen.

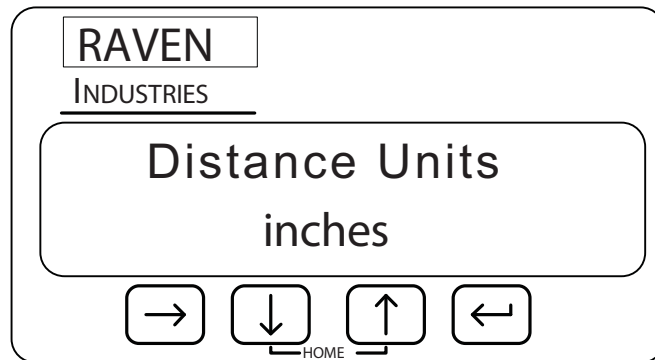
The distance Unit Setting screen allows you to set the distance measurement to display in either feet or metric measurement. You can set the distance to the following units:

- Inches (in)
- Centimeters (cm)





Press  to edit the Distance Units setting. The setting will begin blinking to indicate you are in edit mode. Use the  or  key to toggle between “inches” and “cm.” Press the  key again to finish editing.



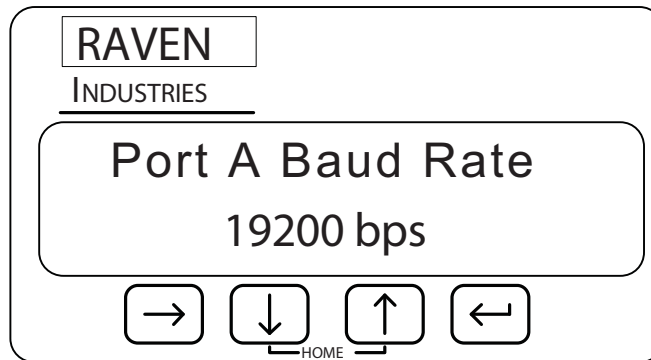

Baud Rate Screens

To get to the Baud Rate screens, press  from the Distance Units screen.

The Baud Rate screens allow you to edit the baud rate for ports A through D. The setting for Port B is used to control the baud rate for the port on the SmartBoom/SmartRow Control Box labeled “DGPS” and port C is normally connected to a product control console on the connector labeled “CONSOLE.” The port C baud rate is only editable if the Console Port setting is set to “NONE.”



Press  to change from Port A to B, etc.

Press the  key to change the Baud Rate setting. The setting will begin blinking to indicate you are in edit mode. Use the  or  key to toggle between possible values (4800, 9600, 19200, 38400, 57600, and 115200). Press the  key again to finish editing.





Note: *If the SmartBoom/SmartRow controller flashes “Console Port!” rather than entering the edit mode, you must first change the console port to “None”. See the “Console Port Screen (SmartBoom Only)” on page 66 for more information.*

Console Port Screen (SmartBoom Only)

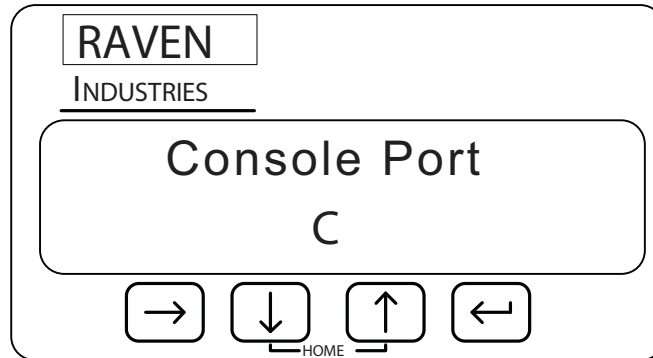
To get to the Console Port screen, press  from the Port D Baud Rate screen.

The Console Port screen allows you to change or disable the port that communicates with a Raven console.







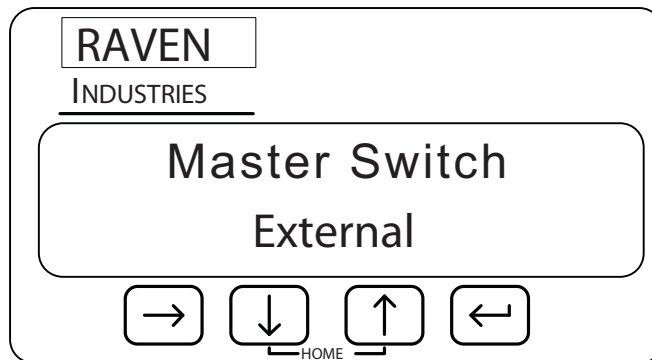

Press  to change the Console Port setting. The setting will begin blinking to indicate you are in edit mode. Use the  or  key to toggle between ports 'A' through 'D' and "NONE." Press the  key again to finish editing. Port 'C' is the default. If the SmartBoom/SmartRow controller is not connected to the serial port on a Raven console, this setting must be set to "NONE" for the system to operate properly.

Master Switch Screen

To get to the Master Switch screen, press  from the Console Port screen.

The Master Switch screen allows the operator to configure the Master Switch that will enable or disable SmartBoom boom section control.



Press  to edit the Master Switch setting. The setting will begin blinking to indicate you are in edit mode. Use the  or  key to toggle between “External” or “Enter Key.” Press the  key again to finish editing. The default setting is “External”. When set to “Enter Key,” the operator can enable SmartBoom from the Home screen by pressing the  key.

When set to “External” and when using a Raven console such as the SCS 440 or 4400, SmartBoom will sense the master switch on the console via the SmartBoom/SmartRow interface cable. If you are using SmartBoom without a Raven console, the orange wire with white stripe must be tied into an external switch to enable/disable SmartBoom.



Receiver Remote Screen

To get to the Receiver Remote screen press  from the Console Port screen.

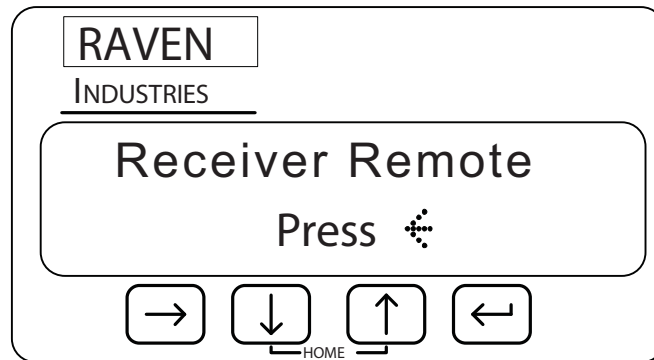
The Receiver Remote screen allows you to configure any Raven GPS receiver that supports a Remote Front Panel such as the RPR115 and RPR110 receivers.



Press  to enable the Remote Receiver feature. If the attached receiver supports Remote Front Panel Mode then its home screen will display within 5 seconds.



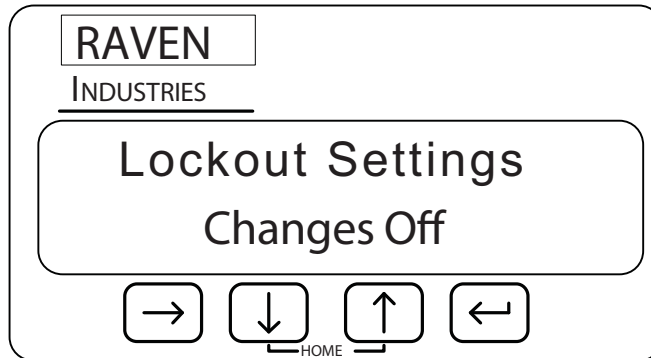

Press the  and  keys simultaneously to exit Remote Front Panel Mode.

Lockout Settings Screen

The Lockout Setting Changes screen allows you to either lock or unlock the settings of the controller. If the Lockout setting is set to ON, a small lock symbol  will appear on all screens affected by the Lockout Setting Changes screen and the settings on those screens will not be editable. If the Lockout setting is set to Off, you can change all values and settings in the SmartBoom/SmartRow controller.



Note: Raven recommends setting the lockout setting to On once all the settings for the controller are set correctly





Press the  key to edit the Lockout Settings Changes setting. The setting will begin blinking to indicate you are in edit mode. Use the  or  key to toggle between "On" and "Off." Press the  key again to finish editing.

Language Settings Screen

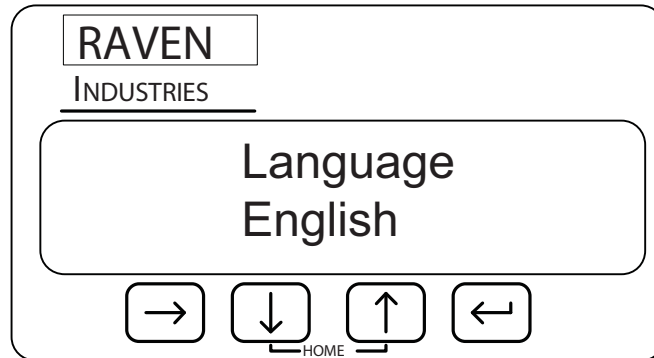
To get to the Language Settings screen press  from the Lockout Settings screen.

The Language Settings screen allows you to select the language of your controller.







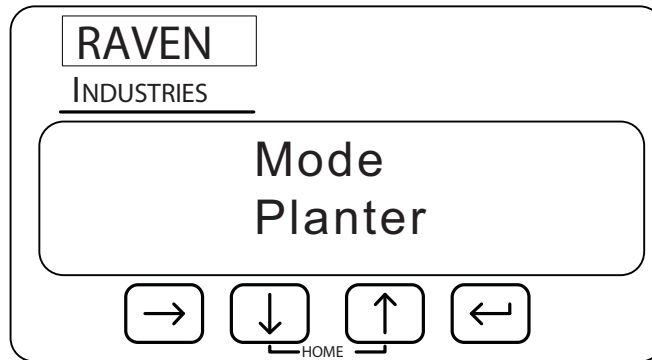

Press  to edit the Language setting. The number will begin blinking to indicate you are in edit mode. Use the  or  key to scroll through the languages. Press the  key again to finish editing.

Mode Selection Screen

To get to the Mode Selection screen press  from the Language Settings screen.

The Mode Settings screen allows you to switch between sprayer, pneumatic and electric planter mode.



Press  to edit the mode. The number will begin blinking to indicate you are in edit mode. Use the  or  key to increase or decrease the value displayed. Use  to switch between planter and sprayer mode. Press the  key again to finish editing.





CHAPTER

9

*SmartBoom Cruizer
Interface and
Calibration*



1. If the SmartRow shield appears instead of the SmartBoom Shield, from the home screen, touch **Tools**, **System**, then **Sprayer** to switch to sprayer mode.

Note: If the Cruizer Lock screen displays on the SmartBoom controller, press the  and  key simultaneously to unlock the controller.

Note: If either the SmartBoom/ SmartRow Shield does not appear, refer to “Check Baud Rate Settings (Cruizer Connection Only)” section on page 97.

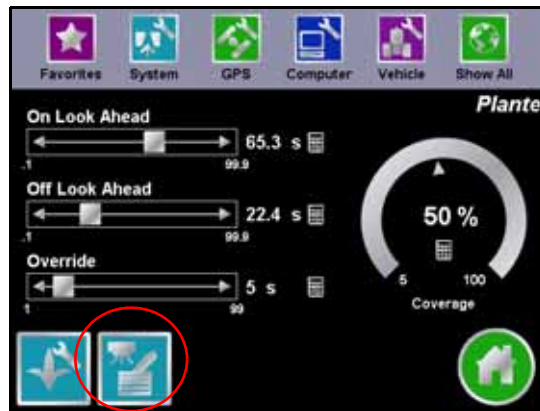

2. Touch the **Sprayer Icon**.
3. The following screen appears.



4. Touch the **Check Mark** to advance.

Note: The Cruizer stores separate settings for the SmartBoom and SmartRow. If you have edited settings before changing implements, you will need to change them again.

Sprayer Section Configuration

Important: *Make sure to set the overall antenna position and overall width before configuring the sprayer sections. If the overall antenna position and width changes, the SmartBoom settings will not automatically update.*

1. From the home screen, touch **Tools**, **Vehicle**, then **Sections** to setup the sprayer sections.

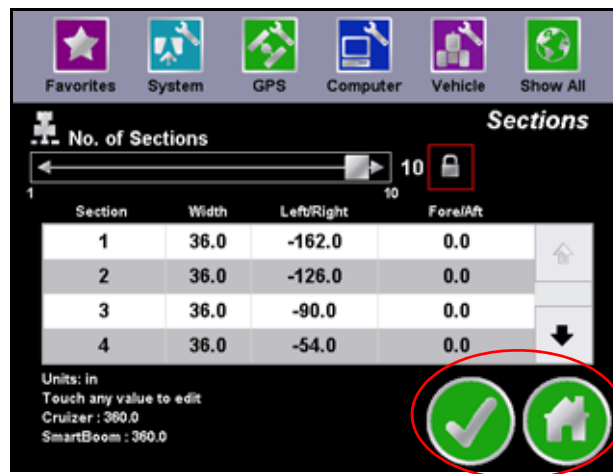

2. Next, use the slider to select the number of sections (maximum of 10 sections). If locked, touch the **Lock Icon** to unlock the number of sections and use the number key pad to enter and exact number of sections.
3. Touch the **Check Mark** to return to the tools screen or touch the **Home Icon** to return to the home screen.

Sprayer Screen

From the home screen, touch **Tools**, **System**, then **Sprayer** to access the Sprayer Screen.

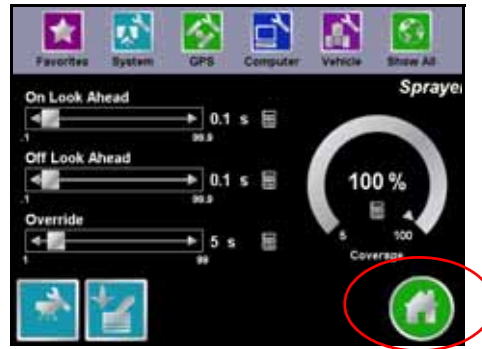

Look Ahead

SmartBoom allows you to pre-program Turn-On and Turn-Off Look Ahead times. SmartBoom monitors the GPS position and as-applied map while considering the Look Ahead times to begin turning sections on or off before they cross spray or no spray boundaries. Look Ahead times can help compensate for delays in the sprayer system including the time it takes for planter clutches to open and close. The specific Look Ahead time is a function of the valve timing and the speed at which the operator is driving the machine.

Percent Coverage

SmartBoom provides the ability to pre-define the amount of coverage SmartBoom will apply. For most applications that require complete coverage, the Percent Coverage should be set to 100 percent. For applications that will not tolerate overlap, the Percent Coverage should be set to a lower value. SmartBoom allows a Percent Coverage value anywhere from 5 to 100 percent in increments of 5 percent.

SmartBoom Override

SmartBoom provides you the ability to momentarily override the SmartBoom feature and force all boom sections on. This may be desired if you want to double up coverage on an area of the field. The override feature is also used when starting off from a dead stop. Enable the SmartBoom Override feature and allow the boom valves to open up before driving ahead. The amount of time for the override can be modified to match your specific application needs. The SmartBoom icon is located on the lower left side of the Guidance Screen. See "SmartBoom Override" on page 76 for more information.

Touch the **Home Icon** to return to the home screen.

Sprayer Controller Setup Screen

From the Sprayer screen, touch the **Sprayer Controller Setup Icon** in the lower left corner to access the Controller Setup screen.

The sprayer Controller Setup screen allows you to set up SmartBoom control parameters for the job you are working on. Under most conditions, these settings will be set and not changed.

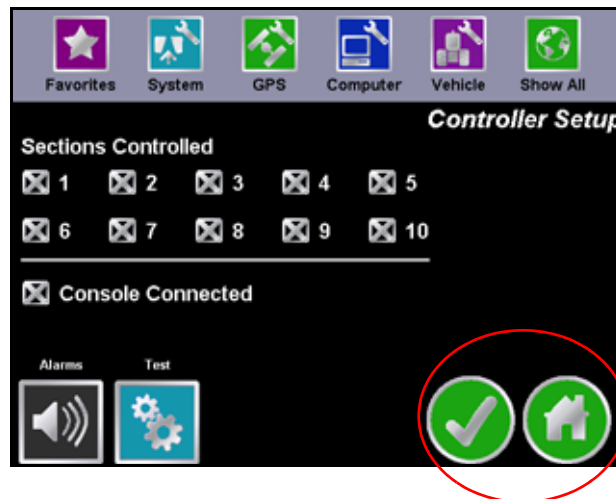

The Section control allows you to individually enable SmartBoom control for different section numbers.

If for any reason the console needs to be disconnected, uncheck the Console Connected box. Console connected will be selected if a 440/450/460/660/4400/4600 console is connected to the SmartBoom.

Touch the **Alarms Icon** to toggle the alarms on and off.

Touch the **Test Icon** to test cycle the sections. Each section will individually turn on for 4 seconds and then turn off. The next section will then be turned on and off and the process will continue until every sections has been cycled on and off.

Touch the **Check Mark** to return to the Sprayer screen or touch the **Home Icon** to return to the home screen.

Guidance Screen

Once the system is configured, you are now ready to begin a guidance session. Refer to the *Cruizer Operator's manual* for instructions on starting a guidance session.

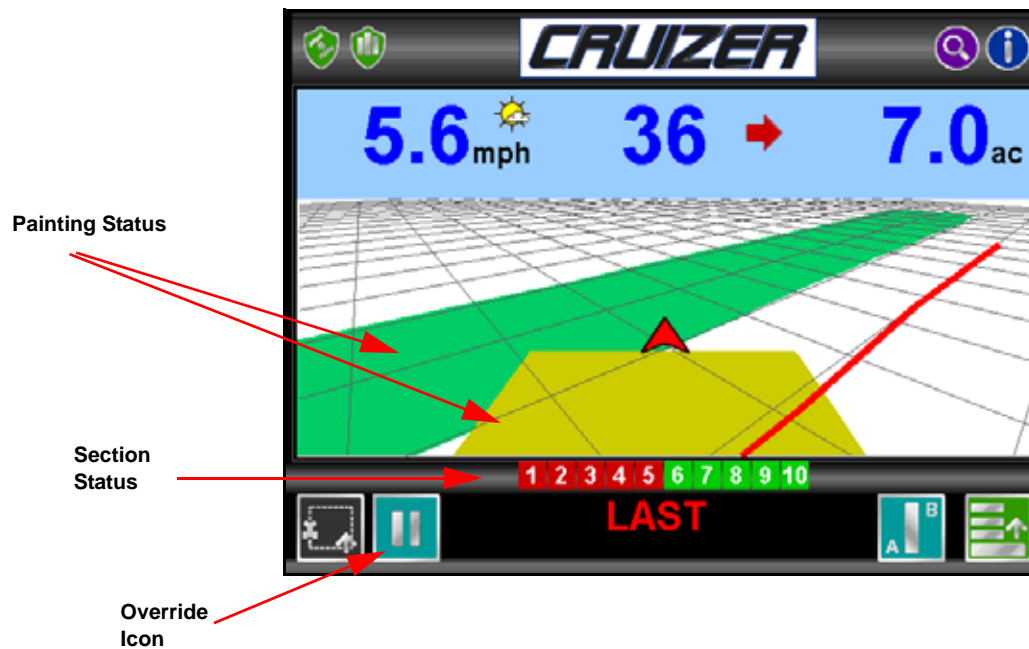

Section Status:

- **Green**= On
- **Red**= Off
- **Black**= Not Controlled

Painting Status:

- **Green**= All sections are On.
- **Yellow**= At least one section is On, but not all of them.
- **Off**= No sections are On.

Override Icon

- Touch this icon to enable the Override feature. See "SmartBoom Override" on page 76 for more information.

Field Review Screen

4. From the Guidance screen, touch:

Menu  **Field Review**  to view the Field Review Screen.

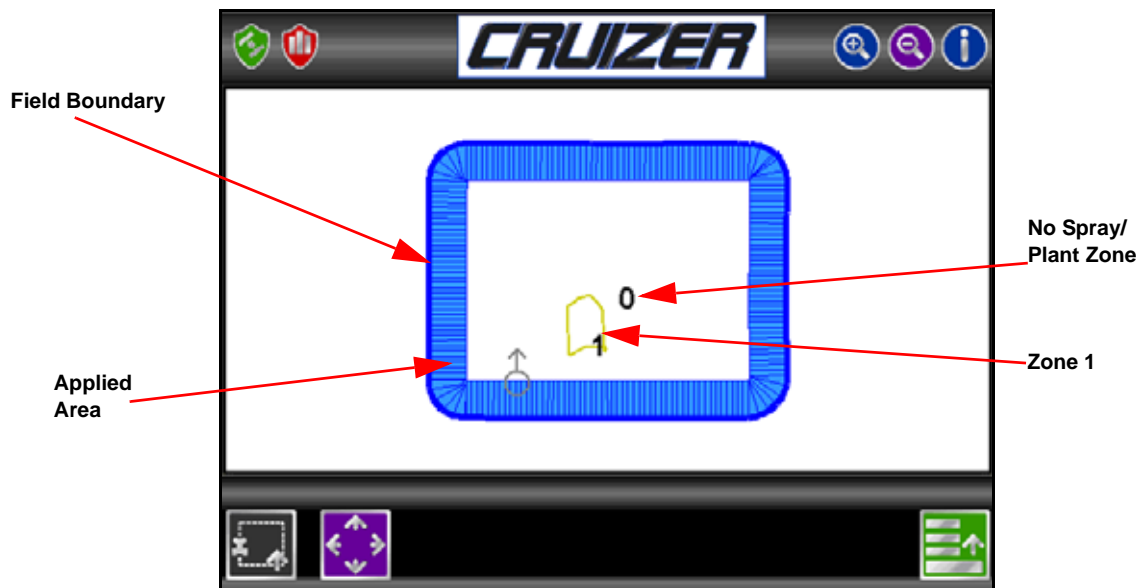

SmartBoom Modes

The available modes for operating SmartBoom are:

- Standard SmartBoom Job
- SmartBoom Job with No Spray Zone
- SmartBoom Job with Field Boundary
- SmartBoom Job with Field Boundary and No Spray Zone

Standard SmartBoom Job

As sections enter previously sprayed areas, SmartBoom automatically turns that section **OFF**. When the section leaves the previously sprayed area, SmartBoom automatically turns the section back **ON**.

The standard field boundary Tools are used while operating in Standard SmartBoom Mode.

No Spray Zone Mapping Mode

No Spray zones may be created and around any areas in which product application should be avoided, such as waterways or around well heads.

For example, as the vehicle crosses into a no spray zone, SmartBoom automatically shuts off any section that enters the no spray zone while other sections remain enabled. As the sections re-enter unsprayed zones, SmartBoom automatically toggles product application back on.

Field Boundaries

Field Boundaries within a SmartBoom enabled Job automatically create a zone map based upon the completed boundary.

SmartBoom assigns a minimum of three implement widths outside of the completed field boundary as a no spray zone.

Note: *When creating a field boundary, the Cruiser does not display the field boundary while driving and the completed boundary only appears in the Field Review Screen. See page 78 for more information.*

The following procedure guides you through recording a no spray zone.

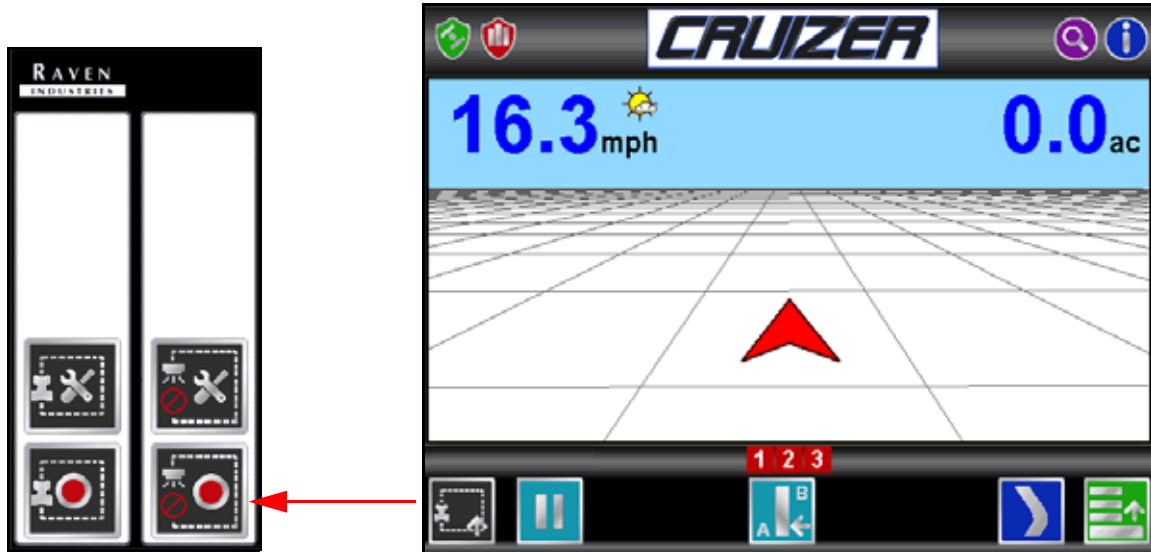

5. Touch:

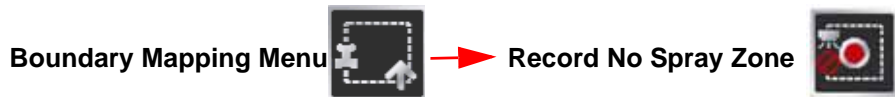



6. Start driving. The area inside of the completed boundary will become a no spray zone.

7. Touch **Stop**  to complete the no spray zone.

Note: The Cruiser automatically stops and completes the recording when the vehicle comes within one boom width of the starting point.

While recording, you can touch **Pause** , **Stop** , and **Reset**  at anytime. When

paused, touch the **Record**  icon and to resume recording the no spray zone.

When the recording is completed, touch  to delete a zone.

Select the **No Spray Zone Mapping Tools Icon**  to display the Reference Point. The

Reference point is the point on the vehicle where Cruiser will record the selected feature's boundary.

- Left and Right End of Sprayer options set the Reference Point at the left or right end of the Guidance Width.
- Center of Sprayer sets the Reference Point at the center of the configured Guidance Width. To set the Reference Point, select the option that corresponds to the orientation of your vehicle with respect to the feature being recorded and then touch the **Check Mark**.





CHAPTER

10

SmartRow Cruizer Interface and Calibration



1. If the SmartBoom shield appears instead of the SmartRow shield, from the home screen, touch **Tools**, **Systems**, then **Planter** to switch to planter mode.

Note: If the Cruizer Lock screen displays on the SmartRow controller, press the  and  key simultaneously to unlock the controller.

Note: If either the SmartBoom or SmartRow Shield does not appear, refer to “Check Baud Rate Settings (Cruizer Connection Only)” section on page 87.

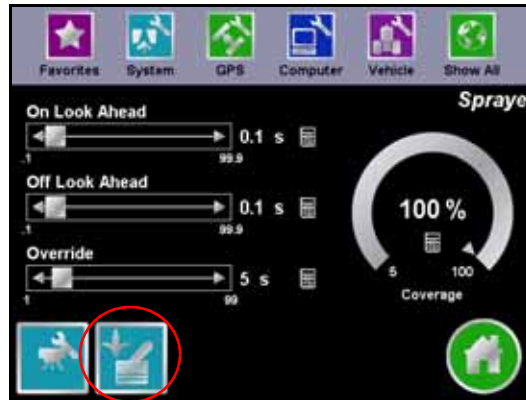

2. Touch the **Planter Icon**.
3. The following screen appears.



4. Touch the **Check Mark** to advance.

Planter Section Configuration

Important: *Make sure to set the overall antenna position before configuring the planter sections. If the overall antenna position changes, the SmartRow settings will not automatically update.*

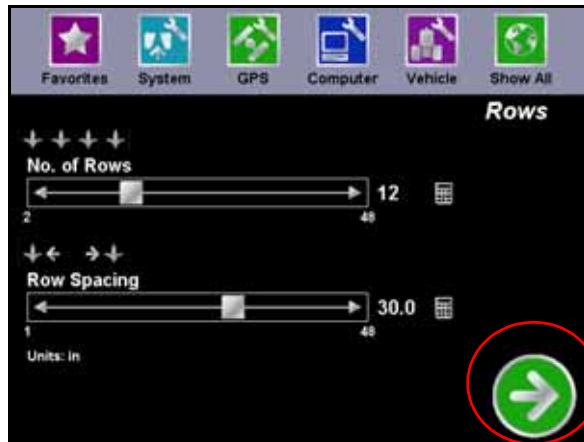

1. From the home screen, touch **Tools**, **Vehicle**, then **Sections** to setup the planter rows and sections.
2. Use the slider to select the number of planter rows (maximum of 48 Rows) or touch the number keypad to enter an exact number of rows.
3. Enter the width in inches between each row.
4. Touch the **Forward Arrow** to advance

*If the overall Cruiser implement width does not match the planter width, you will need to adjust the overall width by touching **Vehicle, Width** and then entering the new width.*

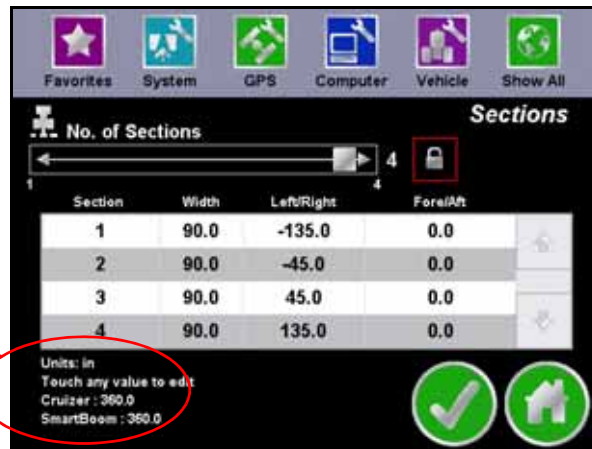

- Next, use the slider to select the number of sections (maximum of 4 sections). If locked, touch the **lock icon** to unlock the number of sections and use the number key pad to enter an exact number of sections.
- Touch the **Check Mark** to return to the tools screen or touch the **Home icon** to return to the home screen.

Planter Screen

1. From the home screen, touch **Tools**, **System**, then **Planter** to setup the planter sections.



Look Ahead

SmartRow allows you to pre-program Turn-On and Turn-Off Look Ahead times. SmartRow monitors the GPS position and as-applied map while considering the Look Ahead times to begin turning sections on or off before they cross plant or no plant boundaries. Look Ahead times can help compensate for delays in the planter system including the time it takes for planter clutches to open and close. The specific Look Ahead time is a function of the valve timing and the speed at which the operator is driving the machine.

Percent Coverage

SmartRow provides the ability to pre-define the amount of coverage SmartRow will apply. For most applications that require complete coverage, the Percent Coverage should be set to 100 percent. For applications that will not tolerate overlap, the Percent Coverage should be set to a lower value. SmartRow allows a Percent Coverage value anywhere from 5 to 100 percent in increments of 5 percent.

SmartRow Override

SmartRow provides you the ability to momentarily override the SmartRow feature and force all boom sections on. This may be desired if you want to double up coverage on an area of the field. The override feature is also used when starting off from a dead stop. Enable the SmartRow Override feature and allow the boom valves to open up before driving ahead. The amount of time for the override can be modified to match your specific application needs. The SmartRow icon is located on the lower left side of the Guidance Screen. See "Guidance Screen" on page 89 for more information.

Touch the **Home Icon** to return to the home screen.

Planter Controller Setup Screen

From the Planter screen, touch the **Planter Controller Setup Icon** in the lower left corner to access the Controller Setup screen.

The Planter Controller Setup screen allows you to set up SmartRow control parameters for the job you are working on. Under most conditions, these settings will be set and not changed.

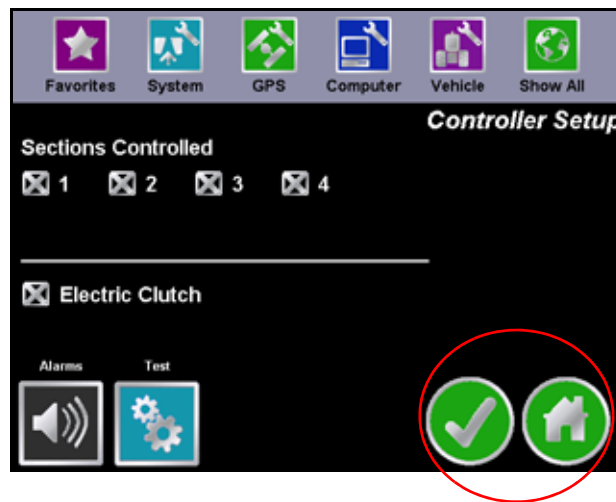

The Section control allows you to individually enable SmartRow control for different section numbers.

Select electric clutch for electric clutch systems and leave unchecked for pneumatic (air) systems.

Touch the **Alarms Icon** to toggle the alarms on and off.

Touch the **Test Icon** to test cycle the sections. Each section will individually turn on for 4 seconds and then turn off. The next section will then be turned on and off and the process will continue until every sections has been cycled on and off.

Touch the **Check Mark** to return to the planter screen or touch the **Home Icon** to return to the home screen

Guidance Screen

Once the system is configured, you are now ready to begin a guidance session. Refer to the *Cruizer Operator's manual* for instructions on starting a guidance session.

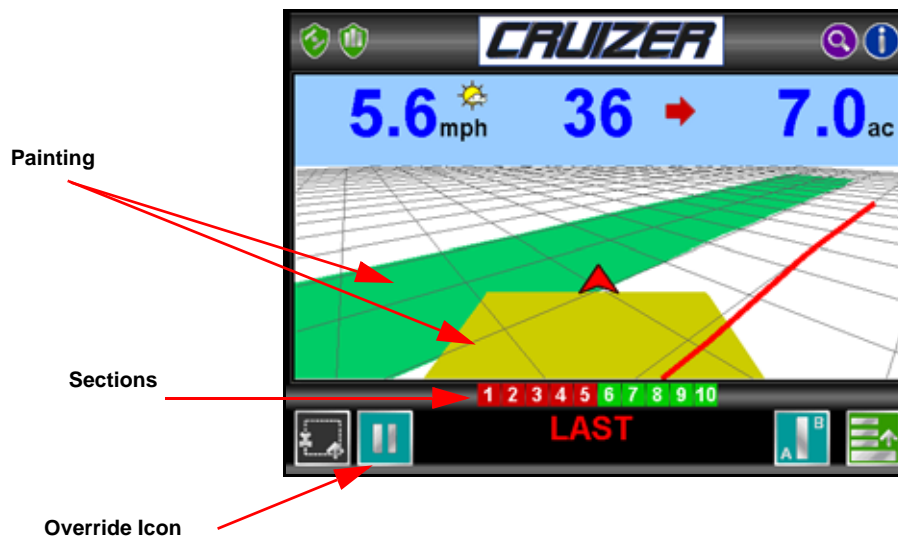

Section Status:

- **Green**= On
- **Red**= Off
- **Black**= Not Controlled

Painting Status:

- **Green**= All sections are On.
- **Yellow**= At least one section is On, but not all of them.
- **Off**= No sections are On.

Override Icon

- Touch this icon to enable the Override feature. See "SmartRow Override" on page 87 for more information.

Field Review Screen

2. From the Guidance screen, touch:

Menu  **Field Review**  to view the Field Review Screen.

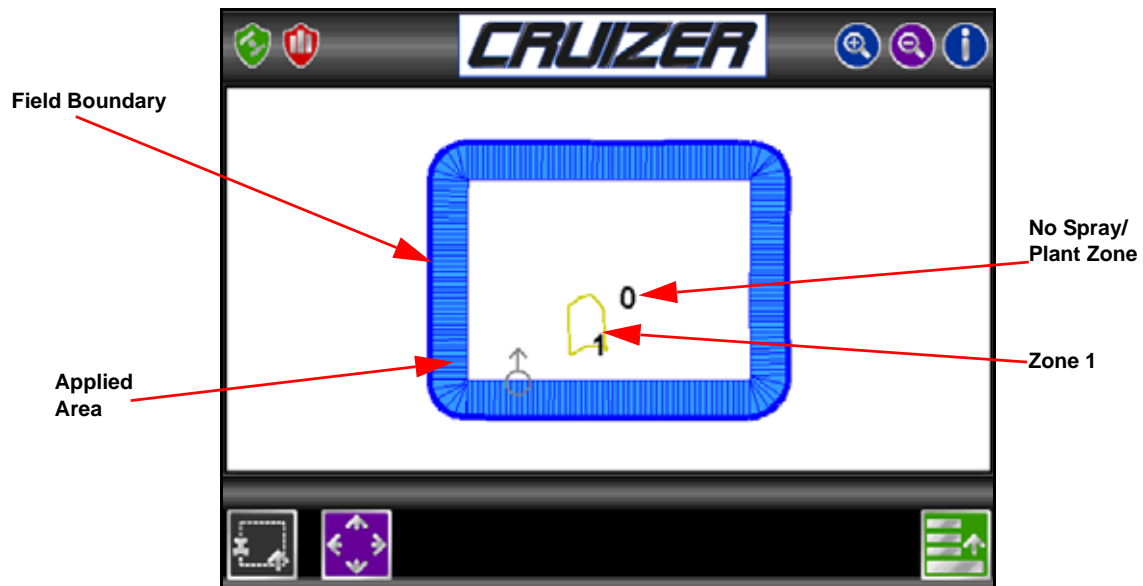

SmartRow Modes

The available modes for operating SmartRow are:

- Standard SmartRow Job
- SmartRow Job with No Plant Zone
- SmartRow Job with Field Boundary
- SmartRow Job with Field Boundary and No Plant Zone

Standard SmartRow Job

As sections enter previously painted areas, SmartRow automatically turns that section **OFF**. When the section leaves the previously painted area, SmartRow automatically turns the section back **ON**.

The standard field boundary tools are used while operating in Standard SmartRow Mode.

No Plant Zone Mapping Mode

No Plant zones may be created and around any areas in which product application should be avoided, such as waterways or around well heads.

For example, as the vehicle crosses into a no plant zone, SmartRow automatically shuts off any section that enters the no plant zone while other sections remain enabled. As the sections reenter un-painted zones, SmartRow automatically toggles product application back on.

Field Boundaries

Field Boundaries within a SmartRow enabled Job automatically create a zone map based upon the completed boundary.

SmartRow assigns a minimum of three implement widths outside of the completed field boundary of a plant zone.

Note: *When creating a field boundary, the Cruiser does not display the field boundary while driving and the completed boundary only appears in the Field Review Screen. See page 90 for more information.*



The following procedure guides you through recording no plant zone.

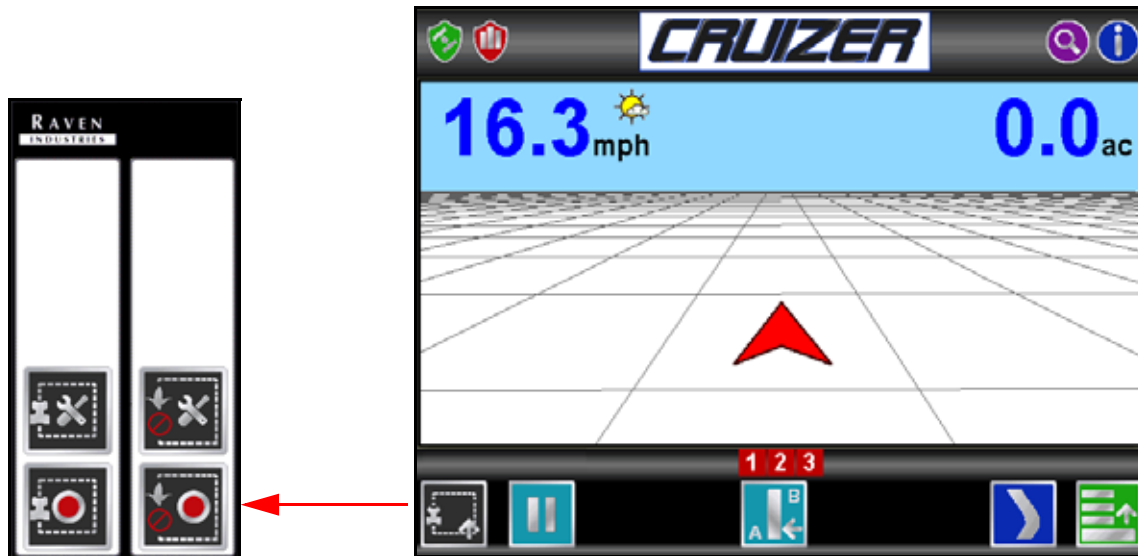





3. Touch:



4. Start driving. The area inside of the completed boundary will become a no plant zone.

5. Touch **Stop**  to complete the no plant zone.

Note: The Cruiser automatically stops and completes the recording when the vehicle comes within one section width of the starting point.

While recording, touch **Pause** , **Stop** , and **Reset**  at anytime. When paused, touch the **Record**  icon and to resume recording the no plant zone.

If a mistake is made and you need to delete a zone, touch .

Select the **No Plant Zone Mapping Tools Icon**  to display the Reference Point. The Reference point is the point on the vehicle where Cruiser will record the selected feature's boundary.

- Left and Right End of Planter options set the Reference Point at the left or right end of the Guidance Width.
- Center of Planter sets the Reference Point at the center of the configured Guidance Width. To set the Reference Point, select the option that corresponds to the orientation of your vehicle with respect to the feature being recorded and then touch the **Check Mark**.

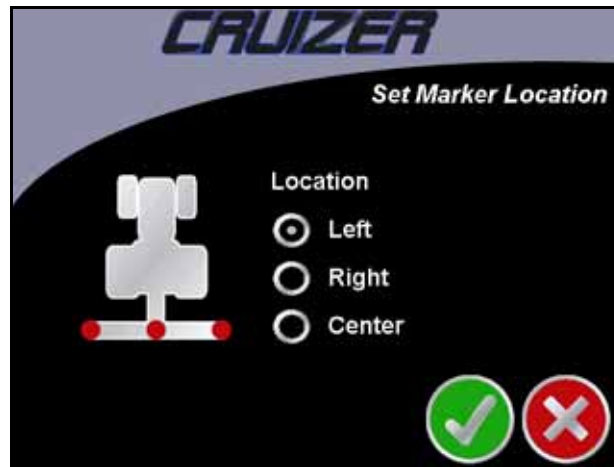

CHAPTER

11

SmartBoom/ SmartRow Troubleshooting

There are a few common problems that you may encounter while using your SmartBoom/SmartRow system. This section provides a list of these issues and some easy troubleshooting tips you can use to diagnose and solve these issues yourself.

Check the Installation

Check any connections to the SmartBoom/SmartRow controller. Make sure:

- Power Connection: Make sure power cable is connected securely to the back of the SmartBoom/SmartRow Controller.
- Console Communications Connection: Make sure the console communication cable is connected to the back of the SmartBoom and the back of the product control console.
- GPS Receiver Connection: Make sure the GPS connection is secure on the back of the SmartBoom/SmartRow Controller as well as the GPS receiver.
- Control Connection: Make sure the control cable is secure on the back of the SmartBoom and that the control cable is connected to the product control console and the system harness. For SmartRow make sure connected to system cable.

Check for Power

Make sure power is being supplied to SmartBoom/SmartRow. If the console has a power switch, make sure the product control console power switch is turned on. If the console and SmartBoom/SmartRow power is supplied from a switched power source, make sure the power key or power switch is turned on.

Check for GPS Reception

Make sure there is power to the GPS receiver and that the GPS receiver is functioning properly. When testing that the GPS antenna is operational, the antenna must be in a location where it can receive unobstructed satellite signals and away from trees and buildings.

Check for GPS Communication

Check the SmartBoom/SmartRow screen for any GPS communications errors. If an error is displayed, troubleshoot the GPS communications issue.

Check for Console Communication (SmartBoom Only)

Make sure there is communication coming from the product control console. One way of testing this is to turn one or more boom switches on and start SmartBoom/SmartRow. If a signal is present, SmartBoom/SmartRow will indicate that a boom switch is out of position.

Check Baud Rate Settings (Cruizer Connection Only)

- From the **Home Screen**, select:

Configuration Screen  → **GPS**  → **Output** .

When connecting SmartBoom/SmartRow, ensure that port A is selected and all messages are set to zero.

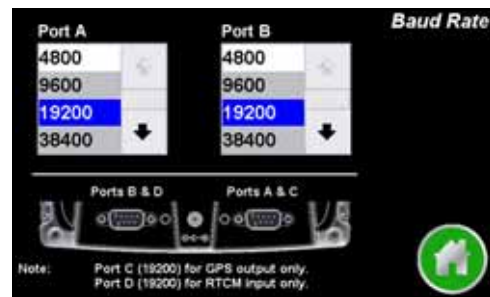
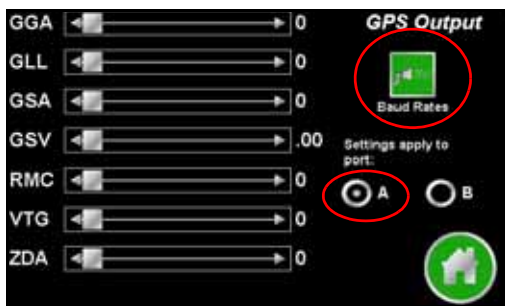







- Touch **Baud Rates** .
- Enter 19200 for the Port A Baud Rate setting.



Clear NV memory in SmartBoom/ SmartRow (Cruizer Connection only) Error Messages

Note: *Clearing the NV memory will clear all the previously entered settings. Use the following table to record current settings before clearing the NV memory. Refer to the SmartBoom Menu Structure on page 16 or the SmartRow Menu Structure on page 34 for assistance with this process.*

Number of Sections	
Section Width	
Fore/Aft	
Left/Right	
On Look Ahead	
Off Look Ahead	

When connecting a SmartBoom to a Cruizer for the first time or after updating software, clearing the NV memory can help ensure that the port settings in SmartBoom are set correctly. To clear the NV memory, press the outside two buttons   on the SmartBoom simultaneously. This will display the diagnostic menu. Press the down button  until the “Clear NV Memory” appears. Press the enter button  to enable the setting and then the down button  to change the entry to “Yes.” Press the enter button  one more time to initiate the memory clear.

Error Messages

When SmartBoom/SmartRow detects an issue, the Home screen will display an error message associated with the problem. The table below lists the possible error messages that could display on the home screen, as well as how to correct them.

Error Messages	Problem	Solution
NO GPS	SmartBoom/ SmartRow does not detect a GPS signal	<ul style="list-style-type: none"> • This is normal on startup. Wait at least 5 minutes before trying anything else. • Make sure that the GPS receiver is turned on and receiving a signal. • Make sure that the port setting for SmartBoom/SmartRow and the GPS receiver match. • Make sure that the GPS receiver is outputting GGA and VTG messages at 4 Hz or greater. 10 Hz is the recommended output rate. • The SmartBoom/SmartRow will assign the first port it receives GPS as the main GPS port. If you have switched GPS input ports you need to cycle power
NO DIF	Differential GPS has not been detected	<ul style="list-style-type: none"> • This is normal on startup. Wait 5 minutes. Check the GPS receiver to make sure it has the differential correction function. Contact manufacturer for additional information.
Lo Mem or LoDMem	Less than 20% of memory left	<ul style="list-style-type: none"> • Finish job and start new job.
Flash?	An error has occurred writing to the flash card	<ul style="list-style-type: none"> • If this problem persists, your unit will need to be returned for repair.
NoCons	SmartBoom cannot communicate with the console	<ul style="list-style-type: none"> • Check console data cable. If console does not support serial communication then set SmartBoom console port to NONE through System Config menus.
Dashes	Master switch in off position	<ul style="list-style-type: none"> • Turn on master switch.

Error Messages	Problem	Solution
O in boom position	Boom switch out of position Override Enabled	<ul style="list-style-type: none"> • Turn all console or machine boom switches to the off position. • Override should time out.

Mechanical Problems

Mechanical problems with the vehicle can cause the SmartBoom/SmartRow to not work properly. Before you start troubleshooting the system, trace all hoses and wires to make sure that they are connected to the proper ports and connectors. You can avoid many potential problems by making sure that all wires and hoses are properly connected. The following table lists some common problems and the corrective action needed to fix the problem.

Problem	Solution
SmartBoom/SmartRow will not power up	<ul style="list-style-type: none"> • Turn the key to the On position. • Turn the product controller power switch to on. • Check the fuses. • Check the battery connections. • Test for +12VDC using a voltmeter. • Replace SmartBoom/SmartRow.
SmartBoom/SmartRow displays only half of the screen.	<ul style="list-style-type: none"> • Unplug the power cable from the back of the controller and then reattach it and power up. • Replace SmartBoom/SmartRow.
SmartBoom/SmartRow arrow keys do not function.	<ul style="list-style-type: none"> • Unplug the power cable from the back of the SmartBoom/SmartRow and then reattach it and power up. • Replace SmartBoom/SmartRow. • If Cruizer was recently connected try pressing the [LEFT] [DOWN] buttons to unlock the SmartBoom.
Cannot enter or change the initial settings on SmartBoom/SmartRow	<ul style="list-style-type: none"> • Turn off the power to SmartBoom/SmartRow and then turn it back on. • Verify that the Lockout Setting is Off. • Replace SmartBoom/SmartRow.

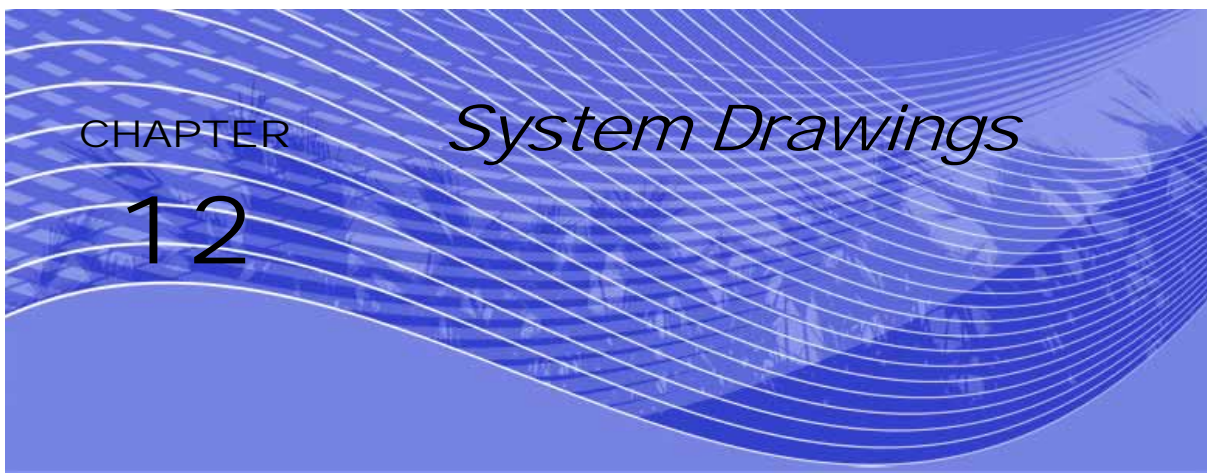
The header graphic features a blue background with white, wavy, grid-like lines. The text 'CHAPTER 12' is positioned on the left side, and 'System Drawings' is written in a large, elegant, italicized serif font on the right side.

CHAPTER
12

System Drawings

The following diagrams may be helpful for installing or troubleshooting the SmartBoom/ SmartRow system. The following diagrams may show optional features or components not required for operation and will not apply to your system if the required hardware has not been installed.

Contact your local dealer for purchasing or more information on components shown in the following diagrams.

Additional system diagrams are available from the Raven Industries web site:

<http://www.ravenprecision.com/Support/ApplicationDrawings/index2.jsp>

SMARTROW ELECTRIC CLUTCH KITS

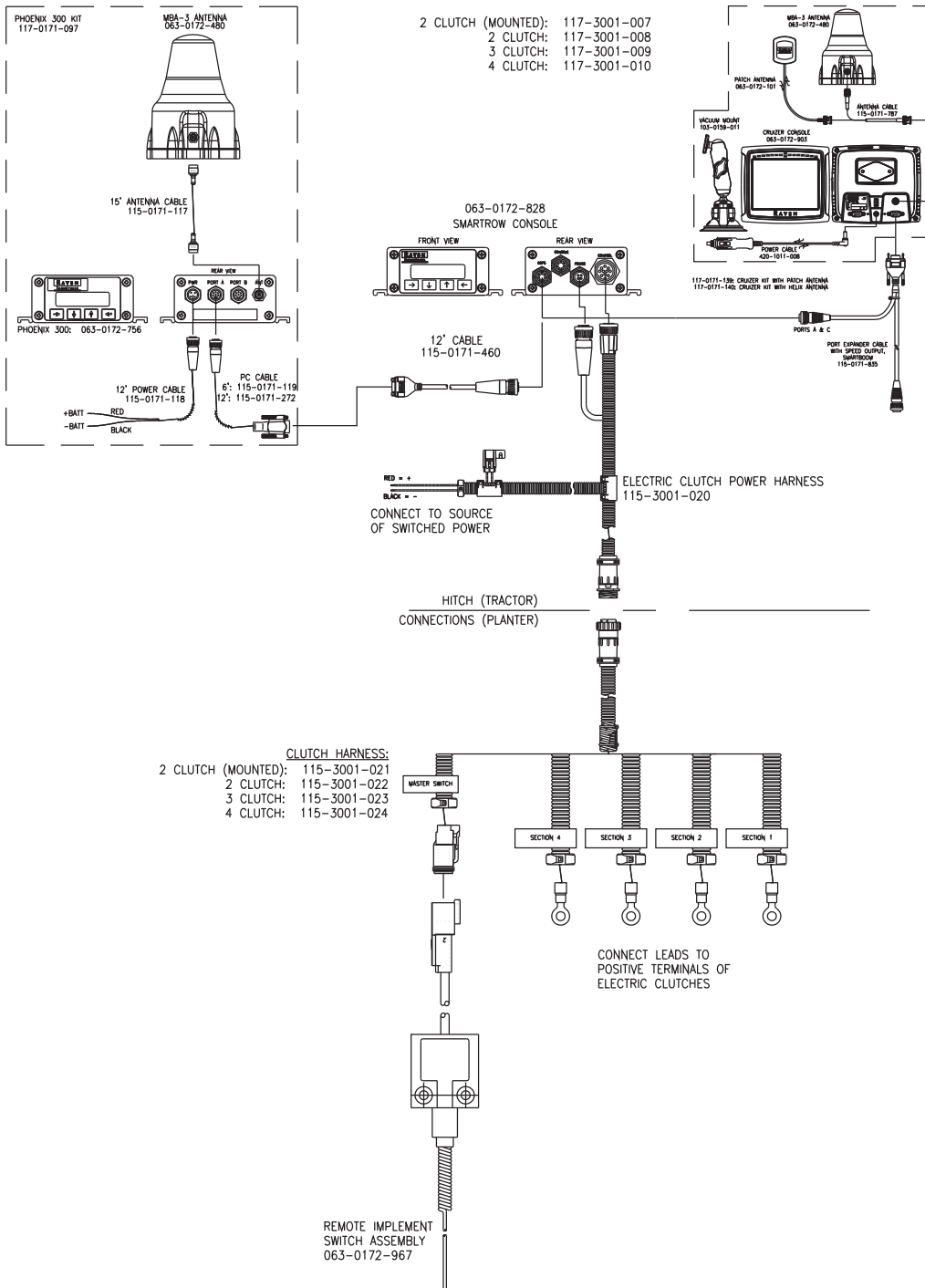

SMARTROW AIR CLUTCH KITS 117-3001-006

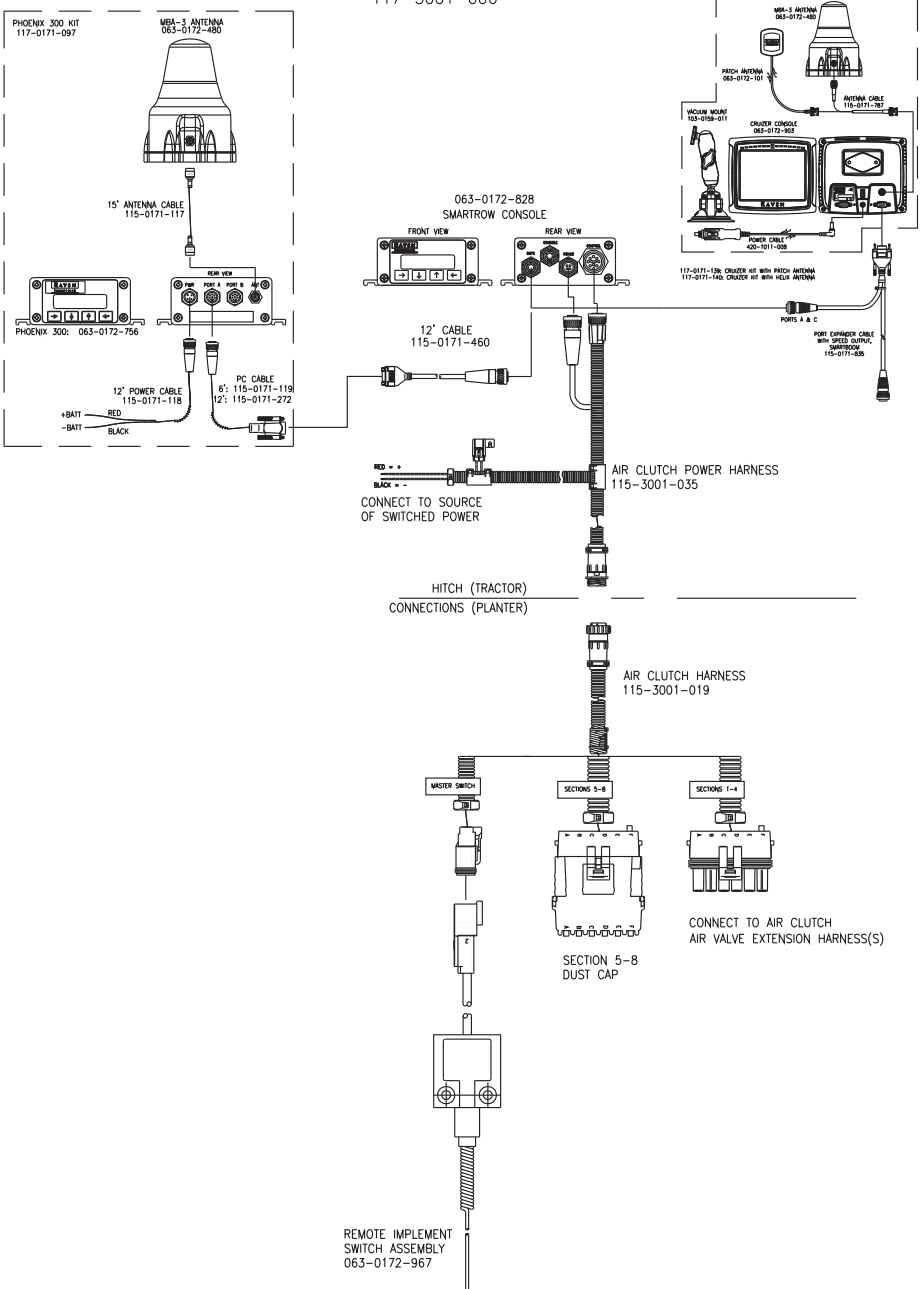

SMARTBOOM + CRUIZER, SCS 440/450/460/660

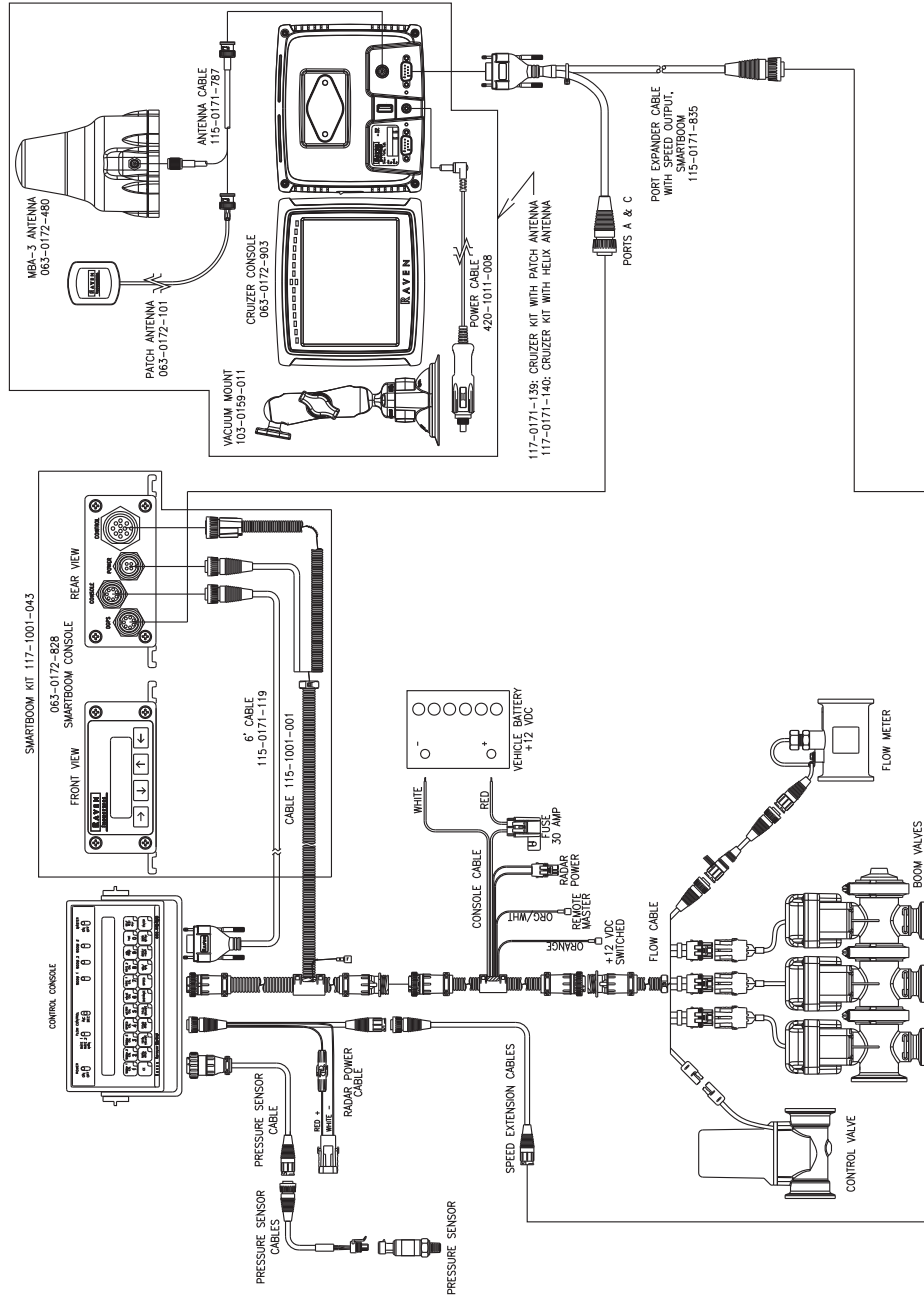

A

About SmartBoom Jobs 10
About SmartRow Jobs 28
Additional SmartBoom Features 12
Additional SmartRow Features 30
Autolocate Sections Screen 50

B

Baud Rate Screens 65

C

Clear NV memory 98
Console Connection (SmartBoom Only) 6
Console Port Screen (SmartBoom Only) 66
Control All Sctns Screen 54
Control Section Screens 55
Cruizer Connection 6
Cruizer No Plant Zone Mapping Mode 91
Cruizer No Spray Zone Mapping Mode 80
Cruizer Planter Controller Setup Screen 88
Cruizer Planter Screen 87
Cruizer Planter Section Configuration 85
Cruizer SmartBoom Field Boundaries 80
Cruizer SmartBoom Field Review Screen 79
Cruizer SmartBoom Guidance Screen 78
Cruizer SmartBoom Look Ahead 76
Cruizer SmartBoom Modes 80
Cruizer SmartBoom Override 76
Cruizer SmartBoom Percent Coverage 76
Cruizer SmartRow Field Boundaries 91
Cruizer SmartRow Field Review Screen 90
Cruizer SmartRow Guidance Screen 89
Cruizer SmartRow Look Ahead 87
Cruizer SmartRow Modes 91
Cruizer SmartRow Override 87
Cruizer SmartRow Percent Coverage 87
Cruizer Sprayer Controller Setup Screen 77
Cruizer Sprayer Screen 76
Cruizer Sprayer Section Configuration 75
Cruizer Standard SmartBoom Job 80
Cruizer Standard SmartRow Job 91

D

Distance Unit Screen 64

E

Electrical Safety 2
End No Plant Zone Screen 43
End No Spray Zone Screen 24

Error Messages 99

F

F/A Offset Screen 49
Field Boundary Menu 19
Field Boundary Offset Screen 20
Functional Description 4

G

GPS Receiver 6

H

Home Display Screen 17, 35

I

Important Safety Information 1
Individual Fore/Aft Offset Screen 52
Individual L/R Offset Screen 51
Installation 5
Interface Cable 7
Introduction 3

K

Key Beep Screen 63

L

L/R Offset Screen 48
Language Settings Screen 70
LCD Backlight Screen 62
LCD Contrast Screen 62
Left Boom Control 18
Lockout Settings Screen 69
Look Ahead 30

M

Manual Control Screen 17
Manual Control When Stopped 19
Master Switch 7
Master Switch Screen 67
Mode Selection Screen 71

N

No Plant Zone Menu 40
No Plant Zone Offset Screen 41
No Spray Zone Menu 22
Number of Sections Screen 46

O

Off Look Ahead Screen 57
On Look Ahead Screen 56
Override Time Screen 59
Overview 3

P

Percent Coverage 12
Percent Coverage Screen 58
Planter Controller Setup Screen 88

R

Receiver Remote Screen 68
Returning Home 19
Right Boom Control 18

S

Section Width Screens 47
Sections Configuration Menu 45, 53
SmartBoom Display Setup 15
SmartBoom End Field Boundary Screen 21
SmartBoom Front Panel Display 15
SmartBoom Initial Startup 9
SmartBoom Job with Field Boundary 11
SmartBoom Job with Field Boundary and No Spray Zones 11
SmartBoom Job with No Spray Zones 11
SmartBoom Look Ahead 12
SmartBoom Manual Control 13
SmartBoom Menu Structure 16
SmartBoom No Spray Zone Offset Screen 23
SmartBoom Start Field Boundary Screen 21
SmartRow Display Setup 33
SmartRow End Field Boundary Screen 39
SmartRow Field Boundary Menu 37
SmartRow Field Boundary Offset Screen 38
SmartRow Initial Startup 27
SmartRow Job with Field Boundary 29
SmartRow Job with Field Boundary and No Plant Zones 29
SmartRow Job with No Plant Zones 29
SmartRow Left Section Control 36
SmartRow Manual Control 31
SmartRow Manual Control Screen 36
SmartRow Manual Control When Stopped 37
SmartRow Menu Structure 34
SmartRow Override 31
SmartRow Percent Coverage 30
SmartRow Returning Home 37
SmartRow Right Section Control 36

SmartRow Start Field Boundary Screen 39
Standard SmartBoom Job 11
Standard SmartRow Job 29
Start No Spray Zone Screen 23
System Configuration Menu 61
System Drawings 101

T

Test Cycle Sections Screen 60

U

Updates 4

RAVEN

RAVEN INDUSTRIES

Limited Warranty

What Does this Warranty Cover?

This warranty covers all defects in workmanship or materials in your Raven Applied Technology Product under normal use, maintenance, and service.

How Long is the Coverage Period?

Raven Applied Technology Products are covered by this warranty for 12 months after the date of purchase. This warranty coverage applies only to the original owner and is nontransferable.

How Can I Get Service?

Bring the defective part and proof of purchase to your Raven Dealer. If your Dealer agrees with the warranty claim, the Dealer will send the part and proof of purchase to their distributor or to Raven Industries for final approval.

What Will Raven Industries Do?

Upon confirmation of the warranty claim, Raven Industries will, at our discretion, repair or replace the defective part and pay for return freight.

What is not Covered by this Warranty?

Raven Industries will not assume any expense or liability for repairs made outside our facilities without written consent. Raven Industries is not responsible for damage to any associated equipment or products and will not be liable for loss of profit or other special damages. The obligation of this warranty is in lieu of all other warranties, expressed or implied, and no person or organization is authorized to assume any liability for Raven Industries.

Damages caused by normal wear and tear, misuse, abuse, neglect, accident, or improper installation and maintenance are not covered by this warranty.