

SCS 450 Serial Interface Installation and Service Manual

Manual No. 016-0159-831 Rev. E 6/16 E28129

Disclaimer

While every effort has been made to ensure the accuracy of this document, Raven Industries assumes no responsibility for omissions and errors. Nor is any liability assumed for damages resulting from the use of information contained herein.

Raven Industries shall not be responsible or liable for incidental or consequential damages or a loss of anticipated benefits or profits, work stoppage or loss, or impairment of data arising out of the use, or inability to use, this system or any of its components. Raven Industries shall not be held responsible for any modifications or repairs made outside our facilities, nor damages resulting from inadequate maintenance of this system.

As with all wireless and satellite signals, several factors may affect the availability and accuracy of wireless and satellite navigation and correction services (e.g. GPS, GNSS, SBAS, etc.). Therefore, Raven Industries cannot guarantee the accuracy, integrity, continuity, or availability of these services and cannot guarantee the ability to use Raven systems, or products used as components of systems, which rely upon the reception of these signals or availability of these services. Raven Industries accepts no responsibility for the use of any of these signals or services for other than the stated purpose.

Chapter 1	Important Safety Information	1
	Important Safety Information	1
	Hydraulic Safety	2
	Electrical Safety	2
Chapter 2	Introduction	1
	Introduction	1
	Unit Definitions and Conversions	2
	Unit of Measure Definitions	2
	Unit of Measure Conversions	2
	Calculating Machine's Calibration Values	3
	Calculate the Boom Cal Value	3
	Calculate the Speed Cal Value	3
	Calculate the Meter Cal Value	5
	Calculate the Valve Cal Value	5
	Calculate the Rate 1 and Rate 2 Cal Values	6
	Verifying Flow Rate Limits	7
Chapter 3	Calibration Card	9
	Introduction	9
Chapter 4	Installation	11
	Sensor Installation	11
	Raven Radar Speed Sensor	11
	Wheel Drive Speed Sensor	12
	Phoenix 10 GPS Speed Sensor	14
	Flow Meter Installation	15
	Mounting the Flow Meter	15
	Install the Pressure Transducer - Optional	15
	Control Valve Installation	16
	Install the Control Valve	16
	Alternate Bypass Line Plumbing System	17
	Connect the Flow Control Cable Boom Valve Connectors	17
	Console and Cabling Installation	18
	Install the Remote Switch - Optional	20
	Battery Connections	21
Chapter 5	Console Programming and Calibration	23
	Console Identification	23
	Console Features	24
	Button Definitions	25

Console Programming	26
Data Entry	26
Initial Console Programming	26
Changing Initial Console Programming	28
Programming Additional System Data	29
System Features	30
Data Menu	30
Data Logger On/Off	31
Self Test Feature	32
Volume/Min Rate Fault	33
Volume/Area Rate Alarm	33
Low Tank Fault	33
Automatic Rate +/-	33
Control Valve Delay and Valve Advance	33
Zero Speed Shut-Off	34
Data Lock Feature	34
Decimal Shift Feature	35
Chapter 6 Initial System Setup and Testing	37
Initial System Setup	37
Alternate Bypass Line System Setup	38
Initial System Field Test	39
Alternate Bypass Plumbing Initial System Field Test	39
Chapter 7 Preventative Maintenance & Troubleshooting	41
General Preventative Maintenance	41
Flow Meter Maintenance	41
Flow Meter Preventative Maintenance and Adjustment	41
Testing Flow Meter Cables	42
Recalibrating the Flow Meter	43
Speed Sensor Cables	44
Testing Speed Sensor Extension Cables	44
Troubleshooting	45
Console Issues	45
Rate Control Issues	46
Chapter 8 Replacement Parts.....	49

CHAPTER

1

IMPORTANT SAFETY INFORMATION

IMPORTANT SAFETY INFORMATION

NOTICE

Read this manual and the operation and safety instructions included with your implement and/or controller carefully before installing the SCS 450 Serial Interface system.

- Follow all safety information presented within this manual.
- If you require assistance with any portion of the installation or service of your Raven equipment, contact your local Raven dealer for support.
- Follow all safety labels affixed to the system components. Be sure to keep safety labels in good condition and replace any missing or damaged labels. To obtain replacements for missing or damaged safety labels, contact your local Raven dealer.

When operating the machine after installing the SCS 450 Serial Interface system, observe the following safety measures:

- Be alert and away of surroundings.
- Do not operate the SCS 450 Serial Interface system while under the influence of alcohol or an illegal substance.
- Remain in the operator's position in the machine at all times when the SCS 450 Serial Interface system is engaged.
- Determine and remain a safe working distance from other individuals. The operator is responsible for disabling the SCS 450 Serial Interface system when the safe working distance has been diminished.
- Ensure the SCS 450 Serial Interface is disabled prior to starting any maintenance work on the machine or parts of the SCS 450 Serial Interface system.
- Follow all label instructions for proper chemical mixing, handling, and container disposal methods.

 **DANGER**

Thoroughly bleed the nurse tank hose and all other system lines prior to disassembling the flow meter, fittings, and hoses, especially in the case of anhydrous ammonia.

 **CAUTION**

HYDRAULIC SAFETY

- Raven Industries recommends that appropriate protective equipment be worn at all times when working on the hydraulic system.
- Never attempt to open or work on a hydraulic system with the equipment running. Care should always be taken when opening a system that has been previously pressurized.
- When disconnecting the hydraulic hoses or purging is required, be aware that the hydraulic fluid may be extremely hot and under high pressure. Caution must be exercised.
- Any work performed on the hydraulic system must be done in accordance with the machine manufacturer's approved maintenance instructions.
- When installing AutoBoom hydraulics or performing diagnostics, maintenance, or routine service, ensure that precautions are taken to prevent any foreign material or contaminants from being introduced into the machine's hydraulic system. Objects or materials that are able to bypass the machine's hydraulic filtration system will reduce performance and possibly damage the hydraulic valves.

ELECTRICAL SAFETY

- Always verify that the power leads are connected to the correct polarity as marked. Reversing the power leads could cause severe damage to the equipment.
- Ensure that the power cable is the last cable to be connected.
- Disconnect the SCS 450 Serial Interface console before jump-starting the vehicle.
- Disconnect the SCS 450 Serial Interface console before welding any component of the machine.

INTRODUCTION

Congratulations on your purchase of the Raven SCS (Sprayer Control System) 450 Serial Interface! The Raven SCS 450 is designed to provide uniformity of spray applications, regardless of the vehicle's speed. Utilizing a computer-based console, a speed sensor, a turbine-type flow meter, and a motorized control valve, the SCS 450 also functions as an area monitor, speed monitor, and volume totalizer.

The operator sets the target volume per area to be applied, and the SCS 450 automatically maintains the flow. A manual override switch allows the operator to manually control the flow for spot-spraying. The actual volume per area being applied is displayed at all times on the console.

	<p>NOTICE</p> <p>The performance of the SCS 450 relies on the proper installation and preventative maintenance of the system and the sprayer. Review this Installation & Service Manual thoroughly before operating the system.</p>
--	--

UNIT DEFINITIONS AND CONVERSIONS

UNIT OF MEASURE DEFINITIONS

Abbreviation	Definition	Abbreviation	Definition
GPM	Gallons per Minute	cm	Centimeters
lit/min	Liters per Minute	dm	Decimeters
dl/min	Deciliters per Minute	m	Meter
PSI	Pounds per Square Inch	MPH	Miles per Hour
kPa	Kilopascal	km	Kilometers
GPA	Gallons per Acre	km/h	Kilometers per Hour
lit/ha	Liters per Hectare	US	Volume per Acre
ml/ha	Milliliters per Hectare	SI	Volume per Hectare
GPK	Gallons per 1,000 Square Feet	TU	Volume per 1,000 Square Feet
mm	Millimeters	[]	Metric Numbers

UNIT OF MEASURE CONVERSIONS

To convert the METER CAL value into the a unit of measure, divide the original number printed on the Flow Meter label by the desired conversion unit of measure value.

Fluid Ounces Conversion Formula	Liters Conversion Formula	Pounds Conversion Formula
$\frac{\text{Original METER CAL Number}}{128}$	$\frac{\text{Original METER CAL Number}}{3.785}$	$\frac{\text{Original METER CAL Number}}{\text{Weight of One Gallon of Product}}$

Liquid

- 1 US Gallon = 128 fluid ounces
- 1 US Gallon = 3.785 liters
- 1 US Gallon = 0.83267 imperial gallons
- 1 US Gallon = 8.34 pounds (water)

Area

- 1 square meter = 10.764 square feet
- 1 hectare = 2.471 acres or 10,000 square meters
- 1 acre = 0.405 hectares or 43,560 square feet
- 1 square mile = 640 acres or 258.9 hectares

Length

- 1 millimeter (mm) = 0.039 inches
- 1 centimeter (cm) = 0.393 inches
- 1 meter (m) = 3.281 feet
- 1 kilometer (km) = 0.621 miles
- 1 inch = 25.4 mm or 2.54 cm
- 1 mile = 1.609 km

Pressure

- 1 psi = 6.89 kPa
- 1 kPa = 0.145 psi

CALCULATING MACHINE'S CALIBRATION VALUES

CALCULATE THE BOOM CAL VALUE

BROADCAST SPRAYING

Calculate the Boom Cal value in inches [cm] by multiplying the number of tips by the spacing between the tips. Be sure to write down these figures for future reference when programming the console.

FIGURE 1. Boom Sections

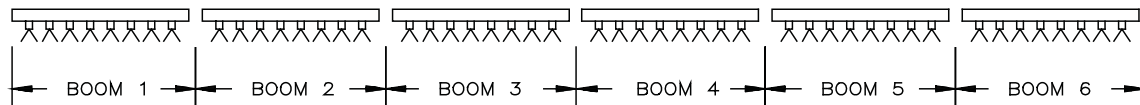

BAND SPRAYING

Calculate the Boom Cal value in inches [cm] by multiplying the number of tips by the spacing between the tips. Calculate the Adjusted Applied Rate by multiplying the Broadcast Rate by the Band Width in inches [cm], then divide by the spacing in inches [cm].

FOR EXAMPLE:

Broadcast Rate	=	20 GPA [200 lit/ha]
Spacing	=	40 inches [100 cm]
Band Width	=	14 inches [40 cm]

$$\frac{\text{GPA} \times \text{Band Width}}{\text{Spacing}} = \text{Adjusted Applied Rate}$$

$$\frac{20 \times 14}{40} = 7 \text{ GPA}$$

$$\frac{[200] \times [40]}{[100]} = 80 \text{ lit/ha}$$

CALCULATE THE SPEED CAL VALUE

RAVEN RADAR ONLY

The initial Speed Cal value for Raven radar is 598 [152]. After the initial console programming has been performed, this value may be adjusted to optimize the system's performance.

Phoenix 10 Speed Sensors Only

The initial Speed Cal value for Phoenix 10 speed sensors is 785 [200]. After the initial console programming has been performed, this value may be adjusted to optimize the system’s performance.

WHEEL DRIVE SPEED SENSORS ONLY

IMPORTANT: Perform this procedure after the system installation is complete. This procedure is critical to the console’s performance, so measure carefully. This procedure should be performed on the same soil conditions in which you will be spraying, since wheel circumference varies in soft soil versus hard-packed soil.

FIGURE 2. Speed Cal Value Calculation

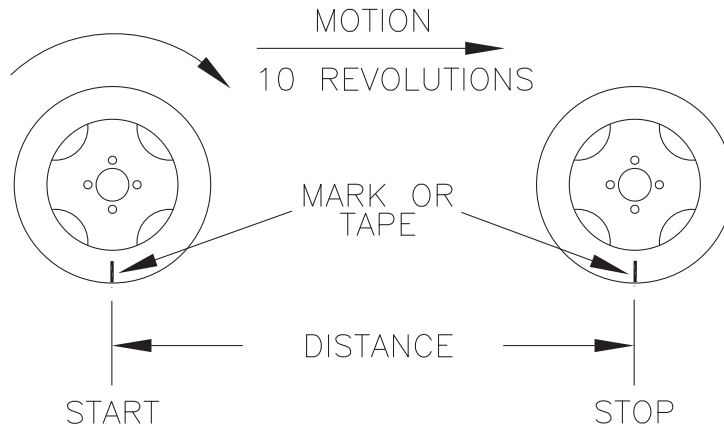

1. Place a chalk mark or tape on the tire on which the speed sensor is mounted.
2. Mark the spot on the ground directly below the chalk mark or tape.
3. Drive the machine straight ahead, counting 10 full rotations of the wheel.

IMPORTANT: The mark must stop at the same position (with the chalk mark or tape perpendicular to the ground at the bottom of the tire) as before it was before the measurement began.

4. Measure the distance (in inches/cm) from the ground starting mark to the stopping mark. Round off fractions of an inch/cm.
5. Write down this number as it will be used as the Speed Cal value when programming the console.

NOTE: Large tires and very low speed applications may require additional magnets to ensure accurate speed readings. Any even number of magnets may be used as long as they alternate in color and are equally spaced. After calculating the Speed Cal value, the number must be adjusted according to the actual number of magnets used.

FOR EXAMPLE:

$$\begin{array}{r}
 \text{Normal Number of Magnets} \\
 \hline
 \text{Actual Number of Magnets}
 \end{array}
 \times \text{Calculated Speed Cal} = \text{Adjusted Speed Cal}$$

$$\begin{array}{r}
 4 \\
 \hline
 6
 \end{array}
 \times 1200 = 800$$

CALCULATE THE METER CAL VALUE

No calculation of the Meter Cal value is necessary, since the flow meter calibration value is stamped on the tag attached to each flow meter. Locate this number and write it down for future reference when programming the console.

CALCULATE THE VALVE CAL VALUE

The Valve Cal figure is used to control the response time of the control valve motor to the change in the vehicle's speed. After operating the system, this number may be refined. The initial recommended control valve values are:

- C-SD (standard valve) = 2123
- C-FC (fast-close valve) = 743
- C-F (fast valve) = 743
- C-P (PWM valve) = 43
- C-PC (PWM close valve) = 43

2

FIGURE 3. Valve Calibration Definitions

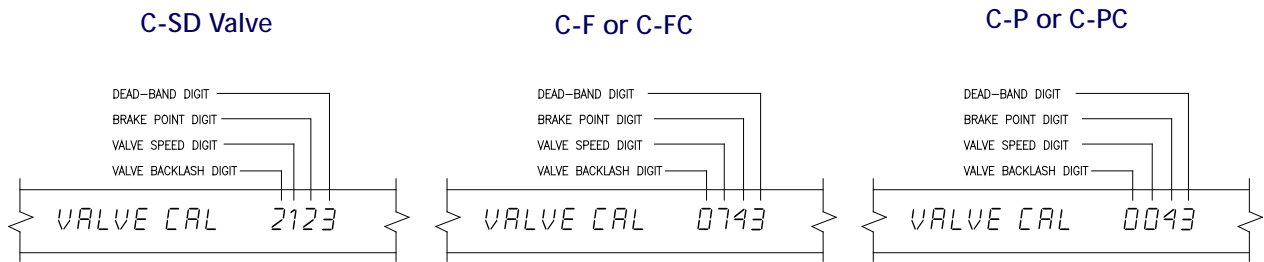

Digit	Description	Range	Range Definition
Valve Backlash	Controls the time of the first correction pulse after a change in correction direction is detected (INC to DEC, or DEC to INC)	1 - 9	1 = Short Pulse 9 = Long Pulse
Valve Speed	Controls the response time of the control valve motor. Caution: Running the control valve too fast will cause the system to oscillate.	Refer to specific valve	Refer to specific valve
	C-SD Valve	1 - 9	1 = Slow 9 = Fast
	C-F and C-FC Valve	0 - 9	0 = Fast 9 = Slow
	C-P and C-PC Valve	0 - 9	0 = Slow 9 = Fast

Digit	Description	Range	Range Definition
Brake Point	Sets the percentage away from target rate at which the control valve motor begins turning at a lower rate.	0 - 9	0 = 5% 1 = 10% 9 = 90%
Dead Band	Allowable difference between the target and actual application rate, where rate correction is not performed.	1 - 9	1 = 1% 9 = 9%

CALCULATE THE RATE 1 AND RATE 2 CAL VALUES

Determine the application rate at which the chemical is to be sprayed, and then consult with your Raven dealer to verify that the spray nozzles are capable of applying at that rate. To determine which spray nozzles to use with the sprayer, the following information must be known:

Nominal Application Pressure _____ PSI (kpa)
 Target Application Rate _____ GPA (lit/ha)
 Target Speed _____ MPH (km/h)
 Nozzle Spacing _____ inches (cm)

With this information, calculate the volume per minute, per nozzle using the following formula:

$$\frac{\text{GPA (lit/ha)} \times \text{MPH (km/h)} \times \text{inches (cm)}}{5,940 [60,000]} = \text{GPM (lit/min)}$$

Refer to the following chart to determine which nozzle to use based on the desired output.

TIP COLOR	TIP NO.		LIQUID PRESSURE IN PSI	CAPACITY 1 NOZZLE IN GPM	CAPACITY 1 NOZZLE IN OZ/MIN	GALLONS PER ACRE 20" SPACING			
	80 DEG.	110 DEG.				5 MPH	6 MPH	7 MPH	8 MPH
YELLOW	XR8002	XR11002	15	.12	15	7.3	6.1	5.2	4.5
			20	.14	18	8.4	7.0	6.0	5.3
			30	.17	22	10.3	8.6	7.4	6.4
			40	.20	26	11.9	9.9	8.5	7.4
			60	.25	32	14.6	12.1	10.4	9.1
BLUE	XR8003	XR11003	15	.18	23	10.9	9.1	7.8	6.8
			20	.21	27	12.6	10.5	9.0	7.9
			30	.26	33	15.4	12.9	11.0	9.7
			40	.30	38	17.8	14.9	12.7	11.1
			60	.37	47	22.0	18.2	15.6	13.6
RED	XR8004	XR11004	15	.24	31	14.5	12.1	10.4	9.1
			20	.28	36	16.8	14.0	12.0	10.5
			30	.35	45	21.0	17.2	14.7	12.9
			40	.40	51	24.0	19.8	17.0	14.9
			60	.49	63	29.0	24.0	21.0	18.2
BROWN	XR8005	XR11005	15	.31	40	18.2	15.2	13.0	11.4
			20	.35	45	21.0	17.5	15.0	13.1
			30	.43	55	26.0	21.0	18.4	16.1
			40	.50	64	30.0	25.0	21.0	18.6
			60	.61	78	36.0	30.0	26.0	23.0

FOR EXAMPLE:

Nominal Application Pressure	30	PSI (kpa)
Target Application Rate	20	GPA (lit/ha)
Target Speed	5.2	MPH (km/h)
Nozzle Spacing	20	inches (cm)

$$\frac{20 \text{ GPA} \times 5.2 \text{ MPH} \times 20 \text{ inches}}{5,940} = .35 \text{ GPM}$$

Based on these calculations and a PSI of 30, tip XR8004 should be selected since it comes closest to providing the desired output.



VERIFYING FLOW RATE LIMITS

The flow rate of spray must be within the specified range for the flow meter being used.

Flow Meter Model	Flow Range
RFM 5	0.1 - 5 GPM [0.2 - 18.9 lit/min]
RFM 15	0.3 - 15 GPM [1.1 - 56.8 lit/min]
RFM 60P	1 - 60 GPM [3.8 - 210 lit/min]
RFM 60S	1 - 60 GPM [3.8 - 210 lit/min]
RFM 100	5 - 100 GPM [18.9 - 380 lit/min]
RFM 200/200 Poly	15 - 200 GPM [56.8 - 760 lit/min]
Magmeter 200	3 - 200 GPM [11.36 - 757 lit/min]
RFM 400	25 - 400 GPM [94.6 - 1515 lit/min]
Krohne 3" Magmeter*	15 - 250 GPM [56.78 - 946.25 lit/min]
Krohne 4" Magmeter*	35 - 1,800 GPM [132.48 - 6813 lit/min]
Krohne 6" Magmeter*	70 - 3,000 GPM [264.95 - 11,355 lit/min]

***NOTE:** Only Krohne Magmeters sold through Raven Industries should be used with Raven controllers. No other Krohne Magmeters are supported.

CHAPTER

CALIBRATION CARD

3

INTRODUCTION

Located on the next page is a card that may be used to record the machine's calibration values. Write the calibration numbers in pencil so that they may be revised if necessary. Cut on the dotted line, fold, and insert the card into the plastic envelope provided for your convenience.

FIGURE 1. Calibration Card Inserted into Envelope

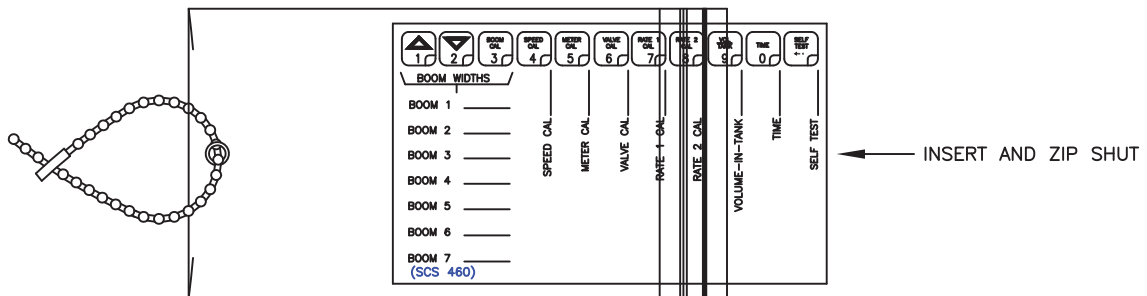















CUT ON DOTTED LINE

FOLD LINE

WARNING: DISCONNECT CONSOLE BEFORE JUMP STARTING, CHARGING BATTERY, OR WELDING ON EQUIPMENT.

DATA ENTRY EXAMPLE: TO ENTER VALVE CAL.

1. PRESS VALVE CAL KEY.
2. PRESS ENTER KEY.
3. PRESS KEYS REQUIRED, TO ENTER PROPER NUMBER.
(EXAMPLE: KEYS    FOR 2123)
4. PRESS ENTER KEY AGAIN.

										
BOOM 1	BOOM 2	BOOM 3	SPEED CAL	METER CAL	VALVE CAL	RATE 1 CAL	RATE 2 CAL	VOLUME-IN-TANK	TIME	SELF TEST

BOOM WIDTHS

BOOM 1 _____

BOOM 2 _____

BOOM 3 _____

BOOM 4 _____

BOOM 5 _____

BOOM 6 _____

BOOM 7 _____

(SCS 460)

SENSOR INSTALLATION

RAVEN RADAR SPEED SENSOR

NOTE: Raven Industries recommends the installation of a large, heavy mounting bracket (P/N 107-0159-693) on the machine's frame for mounting the radar speed sensor.

FIGURE 1. Radar Mounting Locations

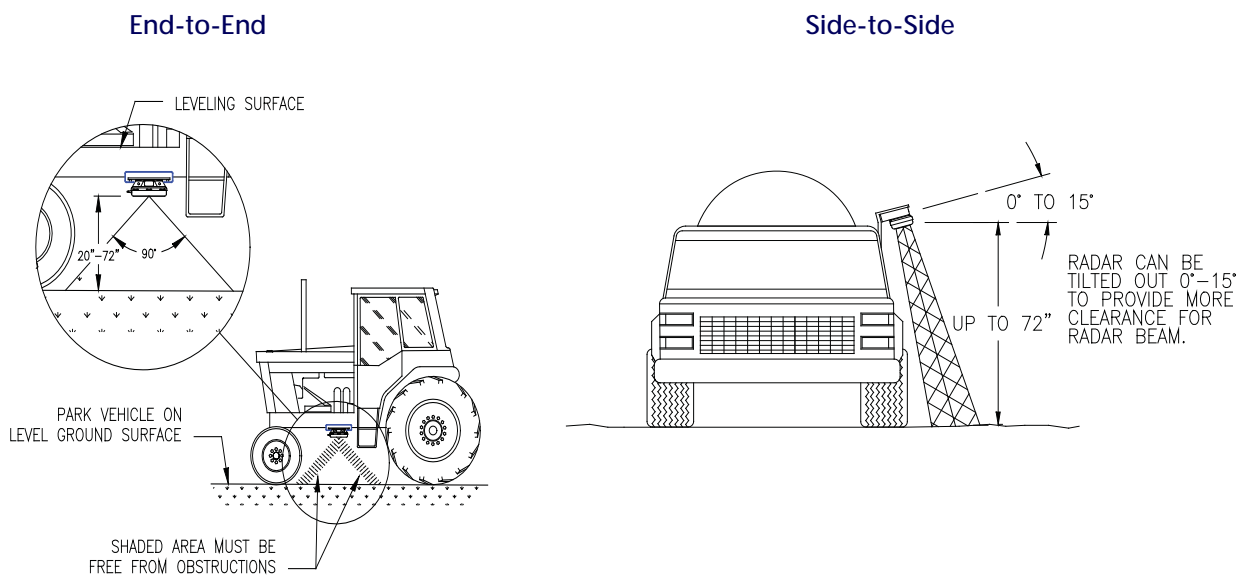

1. Park the machine on a level surface.
2. Select the radar mounting location on the machine, considering the following factors:
 - The line of sight from the lens to the ground must not be obstructed by structures or tires. Obstructions must not come closer to the bottom of the radar than 20”.
 - When viewed from side of the machine (end-to-end view), the radar lens must be parallel to the ground.
 - When viewed from the front of the machine (side-to-side view), the radar may be tilted slightly, with no more than a 15° tilt to provide more clearance and avoid obstructions.
3. Use a level to verify that the selected mounting bracket location is parallel to the ground.
4. Bolt the mounting bracket to the machine.

FIGURE 2. Radar Mounting

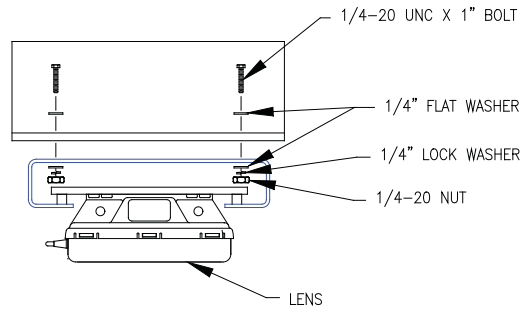

5. Bolt the radar to the mounted bracket using the supplied mounting hardware.
6. Connect the radar power cable (P/N 115-0159-539) to the radar.

NOTE: The radar power cable will be connected to the console later in the procedure.

WHEEL DRIVE SPEED SENSOR

RIM DRILLING FOR FOUR AND EIGHT HOLE WHEEL STUD PATTERNS - OPTIONAL

This section is required only on wheels that do not have pre-punched mounting holes. If your machine has the pre-punched mounting holes, proceed to the Mounting the Wheel Drive Speed Sensor section on the following page.

FIGURE 3. Eight Hole Stud Pattern

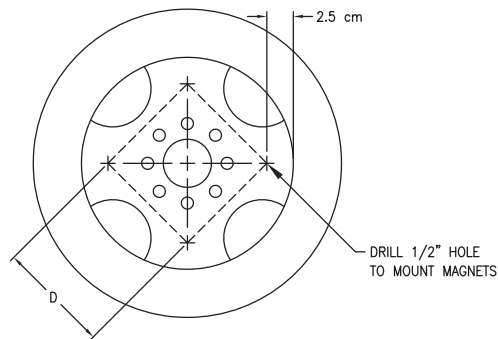

1. Using the illustration above, choose four opposing stud holes on the wheel.
2. Using the center of the opposing stud holes, draw two lines across the wheel, dividing the wheel into four equal parts.
3. Measure in one inch from the rim on each end of the lines and mark the wheel at each point.
4. Drill a 1/2" hole on each of the four marks.

NOTE: The distance between each set of drilled holes must be equal within 1/8" [3 mm] to ensure system accuracy.

RIM DRILLING FOR SIX HOLE WHEEL STUD PATTERNS - OPTIONAL

This section is required only on wheels that do not have pre-punched mounting holes. If your machine has the pre-punched mounting holes, proceed to the Mounting the Wheel Drive Speed Sensor section on the following page.

FIGURE 4. Six Hole Stud Pattern

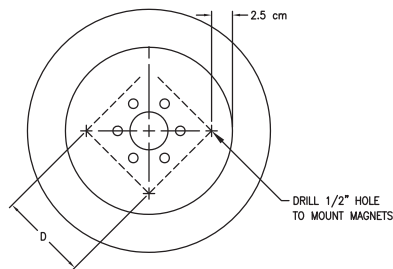

1. Cut a piece of wood so that it is an exact fit from the top edge of the rim to the bottom edge of the rim.
2. Measure the length of the cut wood block and mark the center.
3. Using the wood block as a guide, draw two lines across the wheel, dividing the wheel into four equal parts.
4. Measure in one inch from the rim on each end of the lines and mark the wheel at each point.
5. Drill a 1/2" hold on each of the four marks.

NOTE: The distance between each set of drilled holes must be equal within 1/8" [3 mm] to ensure system accuracy.

MOUNTING THE WHEEL DRIVE SPEED SENSOR

1. Select a non-driven wheel (a front wheel if the machine is rear-wheel drive, or a back wheel if the machine is front-wheel drive) on which to mount the sensors.

FIGURE 5. Wheel Magnet Mounting

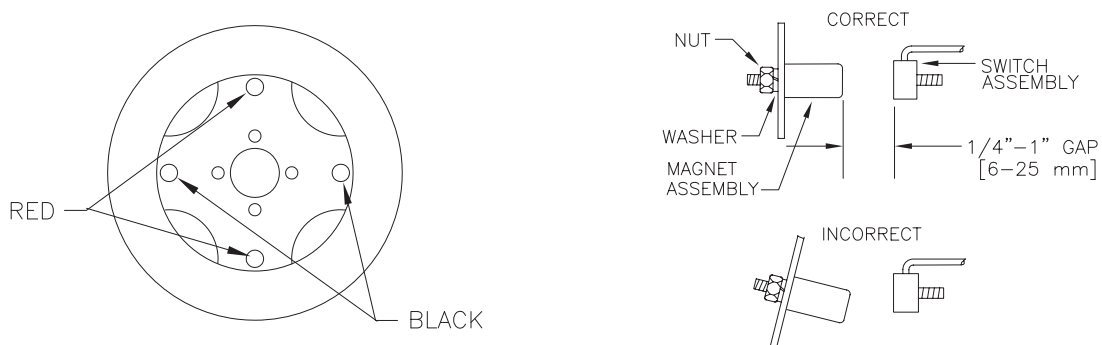

2. Mount the four magnets in the pre-punched or drilled mounting holes on the inside of the wheel so that the red magnets are on opposite sides of the wheel.
3. Tighten the nuts on the wheel magnets to ensure they are installed securely.

FIGURE 6. Switch Assembly Installed

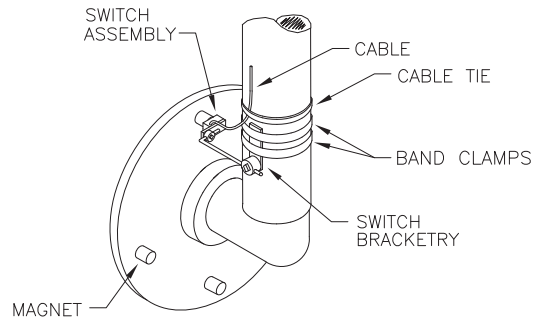

NOTE: The switch assembly does not need to pivot with the wheel.

4. Loosely mount the switch assembly to the wheel axle with the supplied hardware, positioning it so that as the wheel rotates, the magnets pass across the center of the switch assembly.
 - Clearance between the magnets and the switch assembly must be 1/4" - 1" [6 mm - 25 mm].
 - Make sure the machine's wheels can be turned to the extremes in each direction without the magnets coming in contact with the switch assembly.
5. Tighten the mounting hardware to secure the switch assembly.
6. Secure the switch assembly cable to the axle with zip ties.

PHOENIX 10 GPS SPEED SENSOR

FIGURE 7. Phoenix 10 Speed Sensor Installed

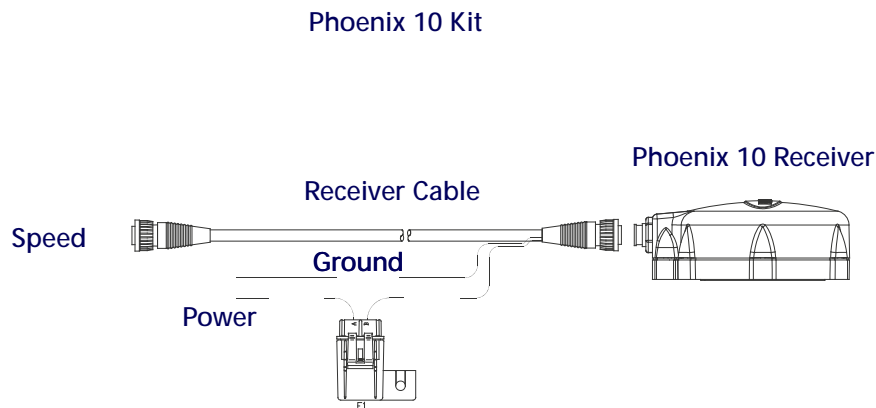

NOTE: The Phoenix 10 is powered by a 9 - 16 VDC negative ground system.

1. Turn off all equipment on the machine to avoid interference with the speed sensor setup.
2. Apply power to the speed sensor by connecting the white wire to a clean ground and the red wire to a clean switched power source.

FLOW METER INSTALLATION

MOUNTING THE FLOW METER

FIGURE 8. Flow Meter Installation Diagram

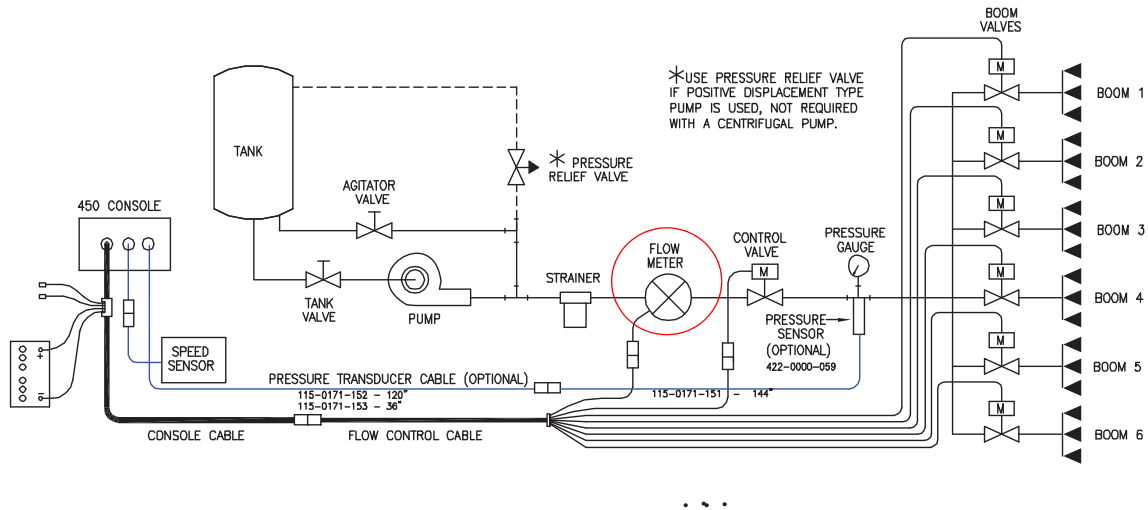

NOTE: All flow through the flow meter must go to the boom sections only. Ensure there are no return, agitation, or sparge lines to the tank or pump after the flow meter.

1. Mount the flow meter in the area of the boom valves (horizontal to the ground) using the supplied bracket. Refer to the figure above.
 - Allow a minimum of 7-1/2" [20 cm] of straight hose on the inlet of the flow meter.
 - The bent radius of the hose on the outlet of the flow meter should be gradual.
 - The flow must be in the direction of the arrow on the flow meter.
2. Connect the female 3-pin connector of the flow control cable to the male flow meter connector.

INSTALL THE PRESSURE TRANSDUCER - OPTIONAL

1. Install the pressure transducer (P/N 422-0000-059) and pressure transducer cables (P/N 115-0171-152 or 115-0171-153 and 115-0171-151).
2. Verify that the pump is turned off and there is 0 psi/kPa of pressure in the lines.
3. Press the DATA MENU button.
4. Enter 0 as the Cal Pressure value.

NOTE: When the system is operating, the system psi/kPa will be displayed when the SPEED or VOL/MIN button is pressed.

CONTROL VALVE INSTALLATION

INSTALL THE CONTROL VALVE

FIGURE 9. Control Valve Installation Diagram

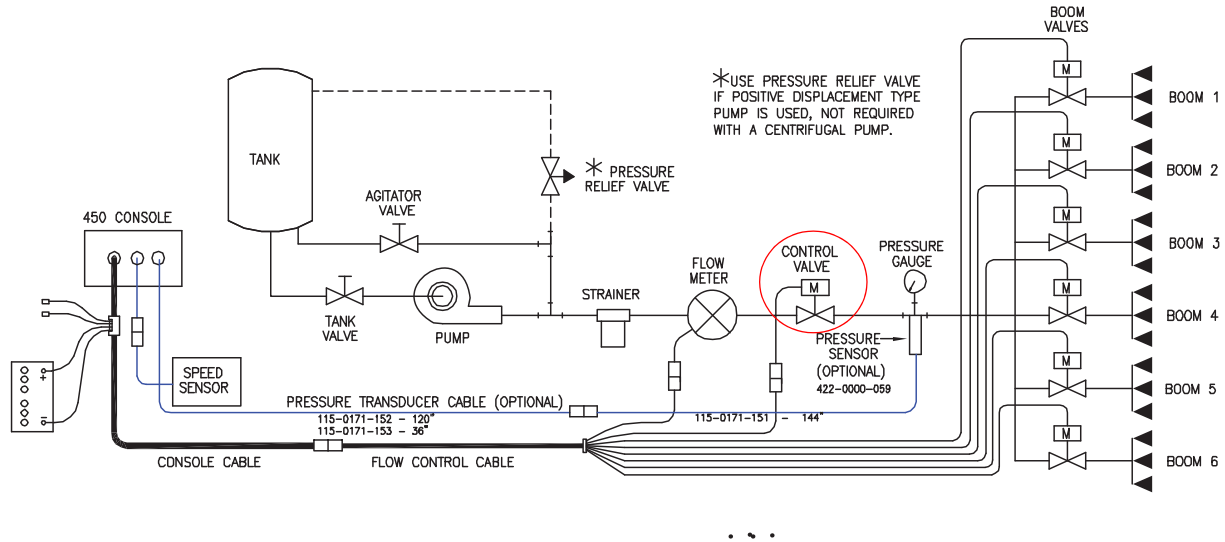

NOTE: This plumbing schematic applies only to applications of 3 GPM [11 lit/min] or greater. For flow less than 3 GPM [11 lit/min], the motorized control valve is mounted on a bypass line. Refer to the Alternate Bypass Line Plumbing System section on page 17 for the alternate bypass line plumbing procedure.

1. Install the control valve on the main hose line between the flow meter and the booms, with the motor in the upright position. Refer to the diagram above.
2. Connect the yellow and green 2-pin connector of the flow control cable to the control valve.

ALTERNATE BYPASS LINE PLUMBING SYSTEM

FIGURE 10. Alternate Bypass Line Plumbing System Diagram

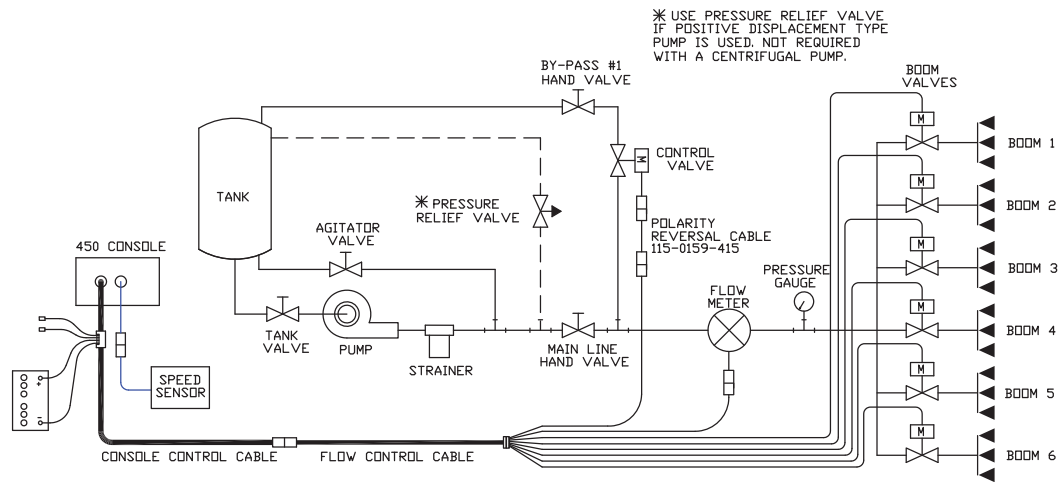

NOTE: This plumbing schematic applies only to applications of less than 3 GPM [11 lit/min]. For flow of 3 GPM [11 lit/min] or greater, the motorized control valve is installed on the main hose line. Refer to the Install the Control Valve section on page 16 for the main hose line plumbing procedure.

1. Install the control valve in the by-pass #1 hand valve line with the motor in the upright position. Refer to the diagram above.
2. Install the reverse polarity cable (P/N 115-0159-415) on the other end of the control valve.
3. Connect the yellow and green 2-pin connector of the flow control cable to the other end of the reverse polarity cable.



CONNECT THE FLOW CONTROL CABLE BOOM VALVE CONNECTORS

1. Connect the boom valve connector with the black or gray signal wire to boom valve #1.
2. Connect the boom valve connector with the brown signal wire to boom valve #2
3. Connect the boom valve connector with the blue signal wire to boom valve #3.
4. Connect the boom valve connector with the black/white signal wire to boom valve #4.
5. Connect the boom valve connector with the brown/white signal wire to boom valve #5.
6. Connect the boom valve connector with the blue/white signal wire to boom valve #6.
7. Connect the boom valve connector with the white/black signal wire to boom valve #7.

CONSOLE AND CABLING INSTALLATION

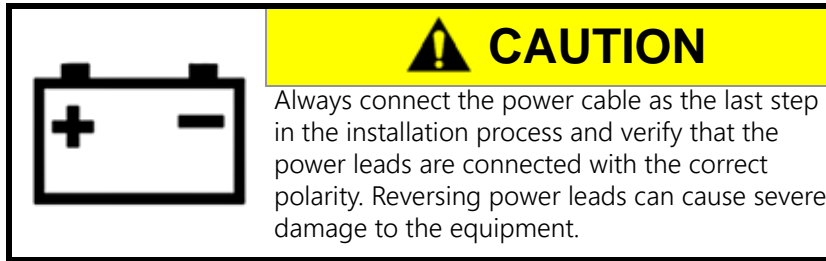

1. Mount the SCS 450 console to a secure area inside the machine's cab.

NOTE: The SCS 450 console should be mounted in the machine's cab so that the machine operator has easy access to it.

2. Connect the female end of the console control cable into the back of the console.
3. If using the Raven radar speed sensor:
 - Connect the radar power wire to the switch power wire on the console control cable.
 - Connect the radar ground to the ground wire on the console control cable.
4. Turn the POWER ON/OFF switch to OFF.
5. Route the power wire on the console control cable to the 12 VDC battery and connect it to the positive (+) battery terminal.
6. Route the ground wire on the console control cable to the 12 VDC battery and connect it to the negative (-) battery terminal.

IMPORTANT: Do not connect the power and ground wires to the machine's starter!

7. Secure the battery wires with zip ties.

IMPORTANT: Do not secure the battery wires near the existing battery leads or any other electrical wiring.

8. Connect the speed sensor cable to the back of the console.
9. Connect the male end of the console cable to the main female connector on the flow control cable.
10. Secure the speed sensor cable and console control cable with zip ties.

FIGURE 11. Console Cabling Diagram

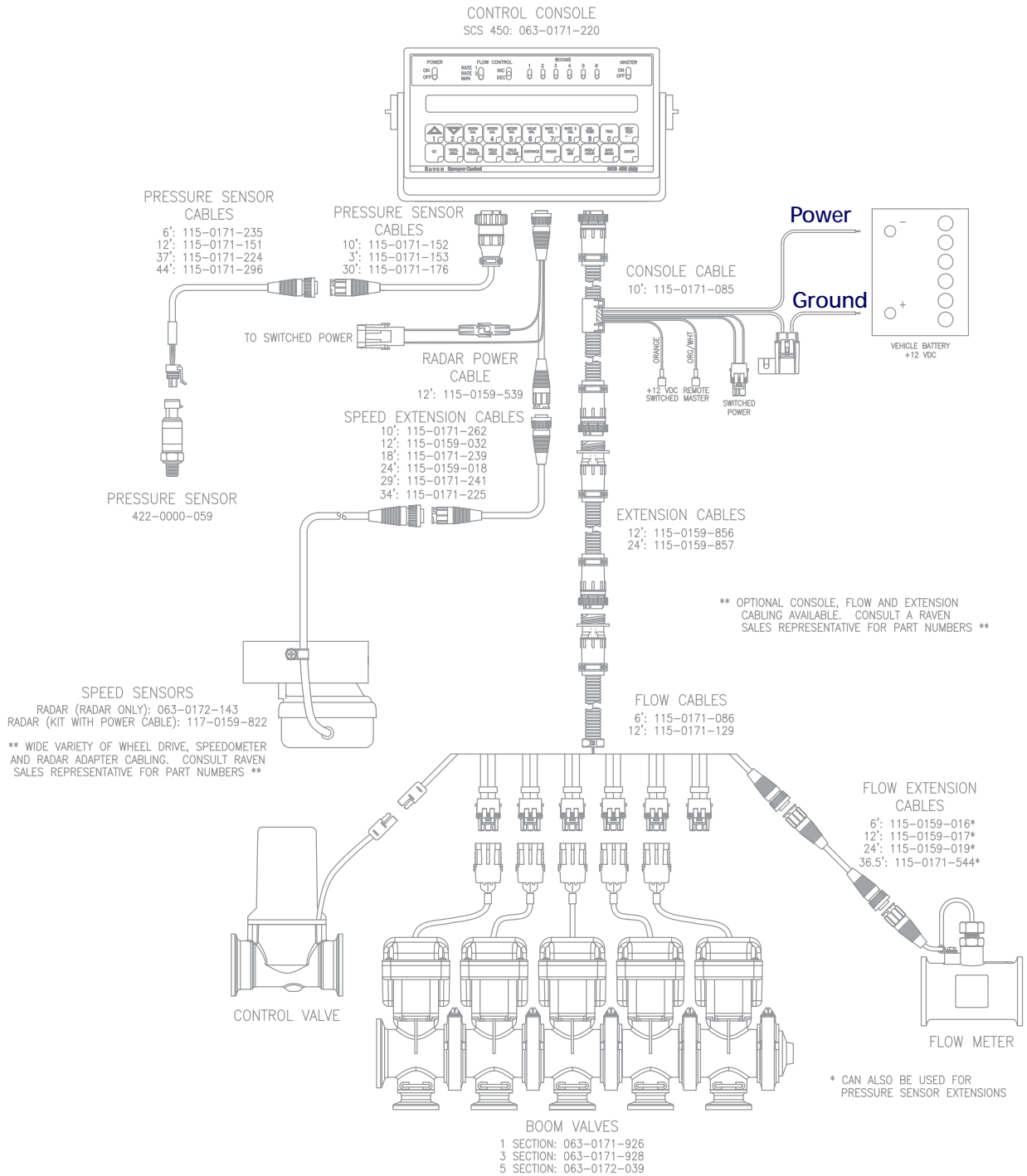

4

INSTALL THE REMOTE SWITCH - OPTIONAL

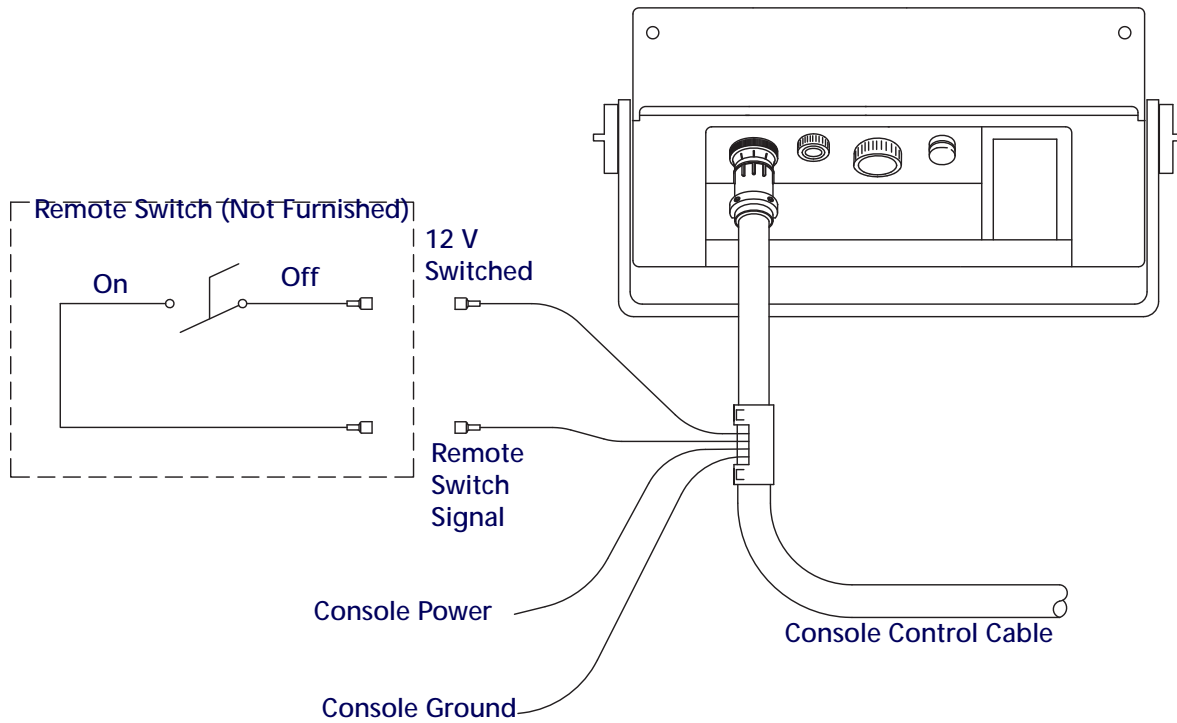

An optional remote switch may be installed if the console is mounted in a location that is not easily accessible. A remote switch may include a foot switch or a toggle switch on the joystick. To utilize the remote switch, the master switch on the console must be turned off. The master switch on the console can be used again once the remote switch is turned off. Refer to the figure above to install the optional remote switch.

BATTERY CONNECTIONS

NOTE: If the system will not be used for an extended period of time (for example, two weeks), be sure to disconnect the SCS 450 battery wires. If the wires are not disconnected and the SCS 450 is only turned OFF, the system will continue to draw 0.25 milliamperes of current to maintain information stored in the console computer, draining the battery.

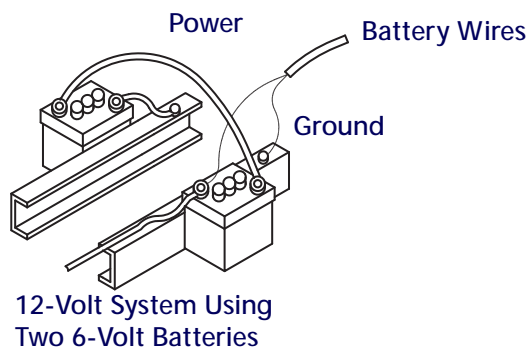
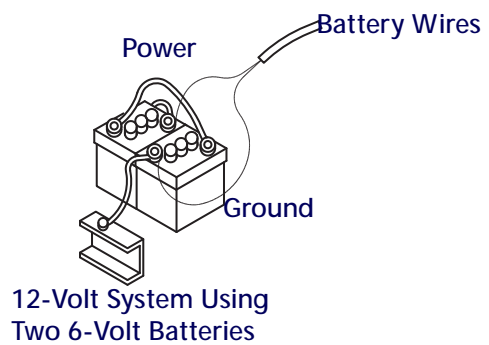
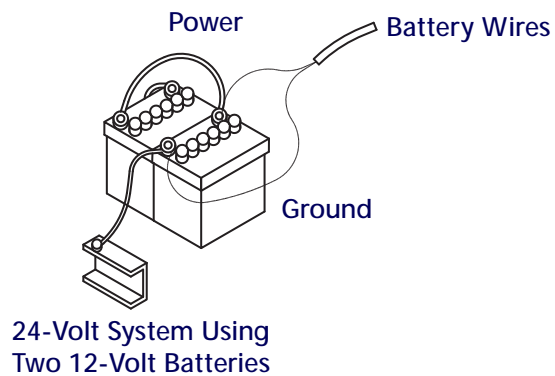
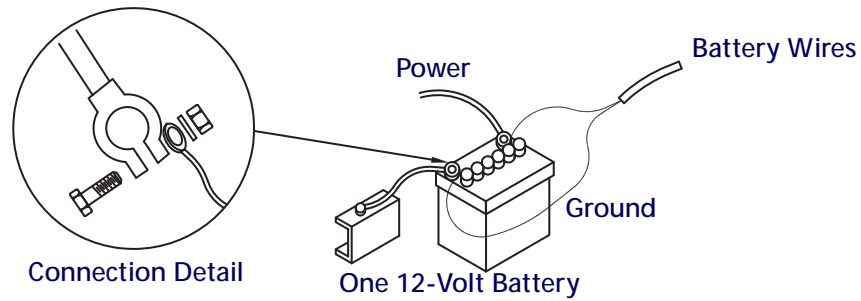

CHAPTER

5

CONSOLE PROGRAMMING AND CALIBRATION

IMPORTANT: The SCS 450 console requires the selection of volume rate (US, SI, or TU), speed sensor type (SP1 or SP2), and valve type (C-SD - standard valve, C-F - fast valve, C-FC - fast close valve, C-P - PWM valve, or C-PC - PWM close valve). Hold the SELF TEST key to review the selections.

CONSOLE IDENTIFICATION

There may be situations that arise during which it may be necessary to contact Raven Industries with questions about the SCS 450 system. The SCS 450 console has an identification label affixed that contains information useful to the Raven customer support team to identify potential issues with the console or system. Please refer to this information on the console when calling to request assistance.

FIGURE 1. Identification Label

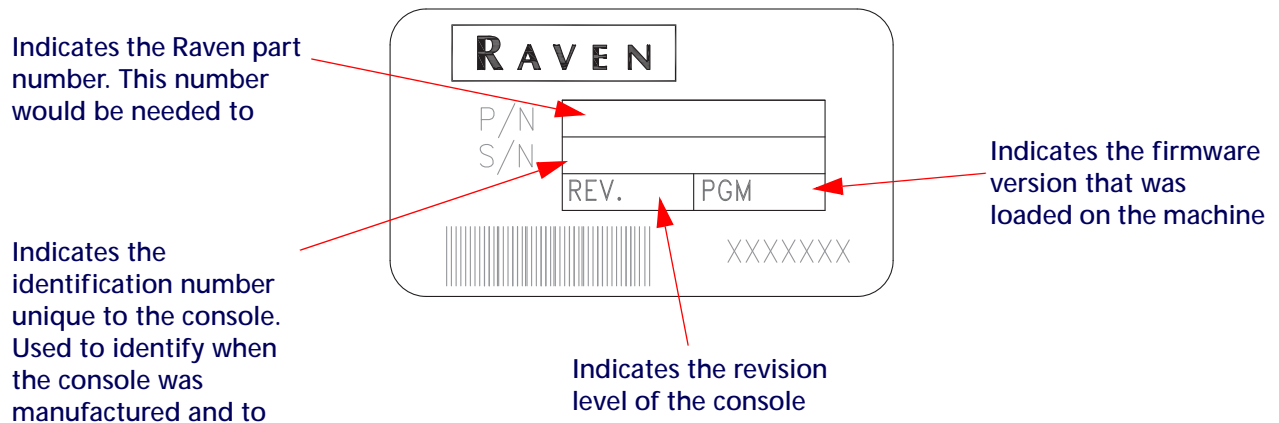

CONSOLE FEATURES

FIGURE 2. SCS 450 Serial Console

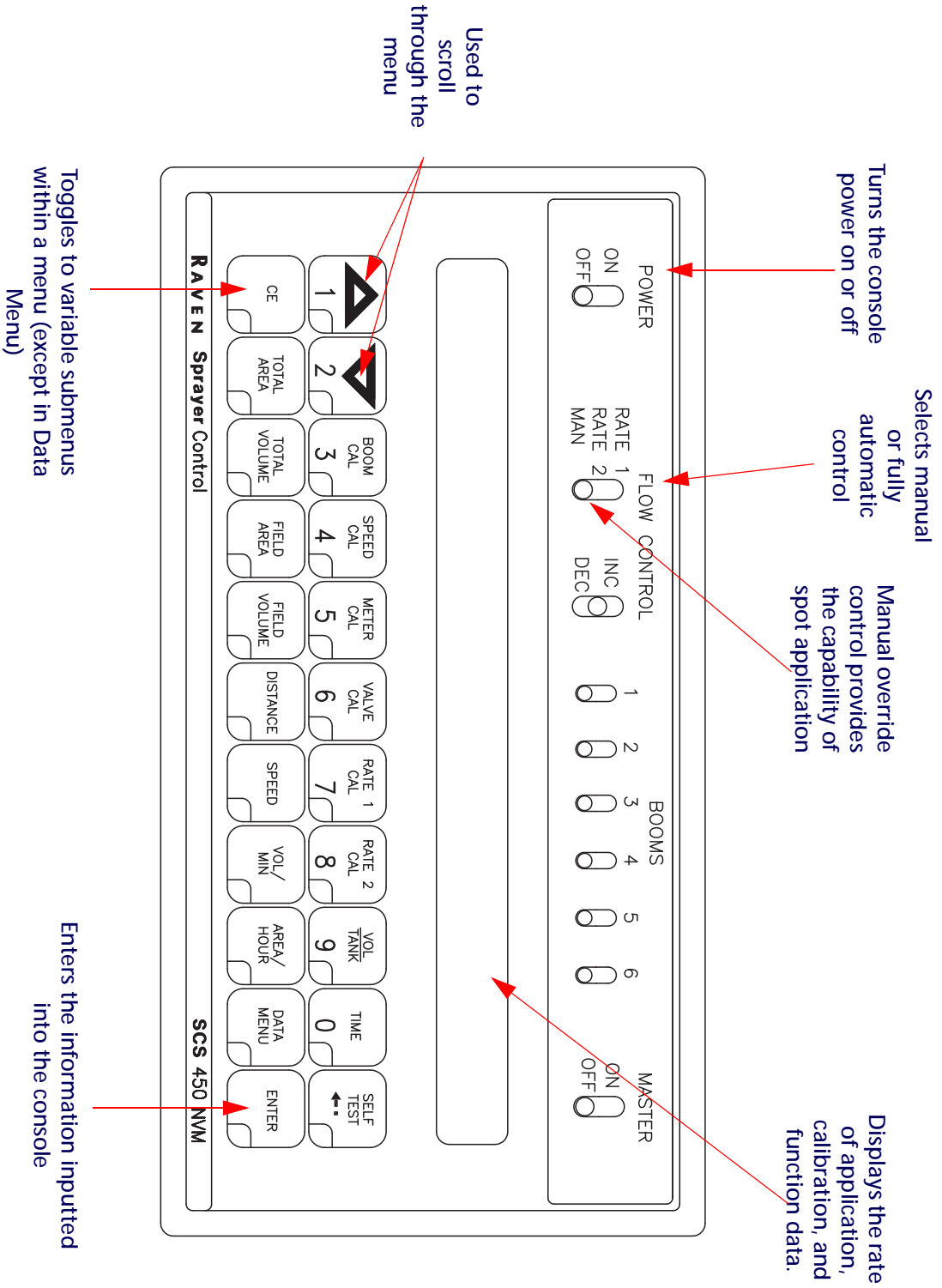

BUTTON DEFINITIONS

CALIBRATION BUTTONS

The calibration buttons are used to enter data into the console when calibrating the system. Refer to the table below for the button names and functions.

Button Name	Function
BOOM CAL	Length of the boom. Select the boom number by using the up/down arrow keys.
SPEED CAL	Determined by speed sensor.
METER CAL	Meter calibration number.
VALVE CAL	Valve response time
RATE 1 CAL	Target application rate.
RATE 2 CAL	Target application rate.
TIME	24 hour clock (military time).

FUNCTION BUTTONS

The function buttons are used to display the data on a particular aspect of the application. Refer to the table below for the button names and functions.

Button Name	Function
TOTAL AREA	Displays total area applied. To zero out this figure, press ENTER, 0, then ENTER in this menu.
TOTAL VOLUME	Displays total volume applied. To zero out this figure, press ENTER, 0, then ENTER in this menu.
FIELD AREA	Displays field area applied. To zero out this figure, press ENTER, 0, then ENTER in this menu.
FIELD VOLUME	Volume applied to the field. To zero out this figure, press ENTER, 0, then ENTER in this menu.
DISTANCE	Displays distance traveled. To zero out this figure, press ENTER, 0, then ENTER in this menu.
SPEED	Displays the vehicle's speed.
VOL/MIN	Displays the volume per minute applied.
AREA/HOUR	Calculates the total area covered per hour at the present speed (not an average).
DATA MENU	Used for data logging and variable rate commands.
SELF TEST	Displays data after selecting volume rate, speed sensor type, or valve type.



CONSOLE PROGRAMMING

DATA ENTRY

NOTE: Data must be entered for all booms and for each of the variables. If a boom is not in use, enter 0 as the value for that boom.

1. Press the number key that corresponds with the variable to be changed:
 - 3 - BOOM CAL
 - 4 - SPEED CAL
 - 5 - METER CAL
 - 6 - VALVE CAL
 - 7 - RATE 1 CAL
 - 8 - RATE 2 CAL
2. Press ENTER. The name of the variable being changed and the letter E will appear in the display.
3. Use the number buttons to enter the value.
4. Complete the data entry by pressing ENTER.

INITIAL CONSOLE PROGRAMMING

After all installation steps have been performed and the console power is turned on, the message "CAL US - VOLUME PER ACRE" will appear in the console's display. This indicates that the console must be calibrated (or programmed) before it can be operated. Console calibration is a one-time procedure that, once it has been performed, does not have to be repeated. Turning off the POWER ON/OFF switch does not affect the console's memory - all data is retained.

IMPORTANT: If an entry or selection error is made during the first six steps of this procedure, turn the POWER ON/OFF switch to the OFF position, press CE and hold while turning the POWER ON/OFF switch to the ON position to reset the console.

Refer to the values that were calculated in the Calculating Machine's Calibration Values section on page 3 when performing the initial console programming.

1. Select the unit of measure (US - Volume per Acre, TU - Volume per Square Feet, or SI - Volume per Hectare) by pressing the CE button until the desired unit of measure appears in the display.
2. Press ENTER. The message "CAL SP1-WHEEL DRIVE" will appear in the console's display.
3. Select the type of sensor being used by pressing the CE button until the desired sensor type appears in the display.

NOTE: If the Phoenix 10 GPS speed sensor is being used, select SP-2 RADAR as the speed sensor type.

4. Press ENTER. The message "CAL C-SD-STANDARD VALVE" will appear in the console's display.
5. Select the type of valve being used by pressing the CE button until the desired valve type appears in the display.
6. Press ENTER. The message "CAL SELF TEST 00" will appear in the console's display.
7. Press the BOOM CAL button. The message "CAL BOOM 1 CAL" will appear in the console's display.
8. Enter the boom width that was previously calculated.

9. Use the arrow keys to advance to the remaining booms and enter the data for each boom.

NOTE: If a boom is not being used, enter 0 for the boom length.

10. Press the SPEED CAL button and enter the appropriate speed cal value for the type of sensor being used.

NOTE: The SPEED CAL value will have to be calibrated if Raven radar is not being used.

11. Press the METER CAL button and enter the meter cal value stamped on the flow meter’s identification tag.

12. Press the VALVE CAL button and enter the calibration number that corresponds with the control valve being used.

13. Press the RATE 1 CAL button and enter the Rate 1 value that was previously calculated.

14. Press the RATE 2 CAL button and enter the Rate 2 value that was previously calculated.

IMPORTANT: The Rate 2 value should not vary by more than 20% from the Rate 1 value, or the spray pattern may suffer. If a second rate is not being used, enter the same value that was entered for the Rate 1 Cal.

The initial console programming is now complete, and the flashing “CAL” in the console’s display should turn off. If it does not, repeat the procedure starting from step 7 above.

REFINING THE SPEED CAL VALUE - RAVEN RADAR ONLY

The initial Speed Cal value when using Raven radar is 598 [152]. However, after initial console programming, it may be necessary to refine this number to improve the system’s performance. Complete the following steps to refine the speed cal value:

1. Turn the POWER switch ON.
2. Turn all boom switches OFF.
3. Press the DISTANCE button on the SCS 450 console.
4. Enter 0 as the value.
5. Drive 1 mile [1 km].

NOTE: Do not use the vehicle’s odometer to determine the distance. Use highway markers or section lines to measure the distance traveled. To achieve the most accurate calibration, accelerate and decelerate slowly using typical application speeds.

6. Press the DISTANCE button. The value should be approximately 5280 [1000]. If the value is between 5260 - 5300 [990 - 1010], the speed cal value for the machine is 598 [152]. If the value is any other value, use the following formula to recalculate the speed cal value.

$$\frac{\text{Old SPEED CAL X 5280}}{\text{DISTANCE VALUE}} = \text{Adjusted Speed Cal}$$

FOR EXAMPLE: Assume that the DISTANCE value is actually displayed as 5000 [980].

$$\frac{598 \times 5280}{5000} = 631.48 \text{ (English)}$$

$$\frac{[152] \times [1000]}{[980]} = 155 \text{ [metric]}$$

IMPORTANT: The new Speed Cal value must be rounded to the nearest whole number.

7. Enter the adjusted Speed Cal value.
8. Recheck the new Speed Cal value by repeating the steps above.

REFINING THE SPEED CAL VALUE - PHOENIX 10 SPEED SENSORS ONLY

The initial Speed Cal value when using the Phoenix 10 speed sensor is 785 [200]. However, after initial console programming, it may be necessary to refine this number to improve the system's performance. Complete the following steps to refine the speed cal value:

1. Verify the SCS 450 console is powered ON.
2. Press the DISTANCE button on the SCS 450 console.
3. Enter 0 as the value.
4. Drive 1 mile [1 km].

NOTE: Do not use the vehicle's odometer to determine the distance. Use highway markers or section lines to measure the distance traveled. To achieve the most accurate calibration, accelerate and decelerate slowly.

5. Check the value in the display. It should be approximately 5280 [1000]. If the value is between 5260 - 5300 [990 - 1010], the speed cal value for the machine is 785 [200]. If the value is any other value, use the following formula to recalculate the speed cal value.

$$\frac{\text{Old SPEED CAL X 5280}}{\text{DISTANCE VALUE}} = \text{Adjusted Speed Cal}$$

FOR EXAMPLE: Assume that the DISTANCE value is actually displayed as 5000 [980].

$$\frac{785 \times 5280}{5000} = 743.4 \text{ (English)}$$

$$\frac{[200] \times [1000]}{[980]} = 204.1 \text{ [metric]}$$

IMPORTANT: The new Speed Cal value must be rounded to the nearest whole number.

6. Enter the adjusted Speed Cal value.
7. Recheck the new Speed Cal value by repeating the steps above.

CHANGING INITIAL CONSOLE PROGRAMMING

Occasionally it is necessary to make changes to the console programming after the initial programming is complete. To make changes to the initial setup:

1. Press SELF TEST and hold it for 30 seconds. The console's display will flash the current program setting.
2. Press CE to advance to the setting that needs to be changed.
3. Press ENTER. The name of the variable being changed will appear in the console's display.
4. Change the variable to the desired setting.
5. Complete the data entry by pressing ENTER.
6. Repeat the steps above for each variable that needs to be changed.

PROGRAMMING ADDITIONAL SYSTEM DATA

Although it is not required for system operation, data may be entered in the VOL TANK and TIME submenus.

VOL TANK

1. Press the VOL TANK button.
2. Press ENTER.
3. Enter the estimated volume of product in the tank.
4. Press ENTER.

NOTE: The VOL TANK variable will have to be updated each time the tank is refilled.

TIME AND DATE

NOTE: The system runs on a 24 hour clock. Therefore, for any time after 12:59 pm, add 12 hours to the time. For example, 8:30 am is entered as 8:30, but 1:30 pm is entered as 13:30 on the keyboard.

1. Press the TIME button. The message "RATE 0.0 TIME 0:00" will appear in the console's display.
2. Enter the time.
3. Press ENTER.
4. Use the arrow keys to toggle to the date fields (MONTH, DAY, YEAR) and enter the data for each of the fields.

POWER DOWN

If the console is not used for 10 days, it reverts to a power down (low power) mode by default. In this mode, all data is retained, but the time of day clock will reset to 0:00. The default date may be changed from 10 days to a number preferred by the user. To change the default power down value:

1. Press the TIME button. The message "RATE 0.0 TIME 0:00" will appear in the console's display.
1. Use the arrow keys to toggle to POWER DOWN.
2. Enter the desired default power down value (the number of days before the system clock is reset to 0:00).

SYSTEM FEATURES

DATA MENU

Pressing the DATA MENU button displays the menu options by name and the default setting. Use the arrow keys to scroll through the menu options.

Menu Option	Function
PRINT FIELD BEGIN	Sends data through the serial port to the attached printer (optional - not supplied by Raven) to Print Field Begin and Print Field End pages. Pressing CE will toggle between the two pages. 1. Press ENTER to print the Print Field Begin. The display will now show PRINT FIELD END. 2. PRESS ENTER to print the Print Field End.
ALARM ON	Turns the audible alarms on and off for the Vol/Minute Rate Fault, Volume/Area Rate Alarm, and Low Tank Fault features. Pressing CE will toggle between Alarm On and Alarm Off.
DISPLAYSMOOTHING ON	Turns display smoothing on and off. Display Smoothing On adjusts the console to display the target rate when the actual rate is within 10% of the target rate. Display Smoothing Off displays the actual target rate. Pressing CE will toggle between the two settings.
RATE CHANGE ALARM ON	Turns the rate change alarm on and off. When the Rate Change Alarm is on, the alarm emits four long beeps when the RATE 1 calibration number is changed via the serial port using a valid change request data string. Pressing CE will toggle between the two settings.
GPS FILE REF 1	This application is not currently used in the SCS 450 system.
GPS INACTIVE	This application is not currently used in the SCS 450 system.
FIELD REF 0	Allows the user to enter up to a four-digit number to represent a field. Field reference is included in the field begin and field end pages and the data logger time/date string.
BAUD RATE 9600	Used in the GPS logging mode. The baud rate option is 1200 - 9600 baud.
DATA LOG TRIGGER VALUE 0	Used in the data logging mode. The trigger determines how often the actual rate data string is sent to the serial port. The trigger may either be in feet/meters or seconds. The default value is set to zero. This value must be changed to a number ranging from 1 - 9999, or the data logger feature will not work.
DATA LOG TRIGGER UNITS FEET	Used in the data logging mode. The trigger may either be in feet/meters or seconds. Pressing CE will toggle between the FEET (METER) and SEC.
DATA LOG OFF	Turns the data logger on and off. NOTE: The trigger value must be set to a figure other than zero in order to toggle DATA LOG to ON.
PRESS ENTER TO CAL PRESSURE	Used to set the zero point of the pressure transducer for pressure display.
OFF RATE PERCENT 30	Used to set the percent of off-target value. The alarm sounds when the actual rate is off from the target rate by a specified percentage. The off-target value is preset to 30%, but may be changed to a different number.

Menu Option	Function
HIGH PWM OFFSET 253	Used to set the maximum desired RPM or hydraulic output of the Pulse-Width Modulated (PWM) control valve. <ol style="list-style-type: none"> 1. In the DATA MENU, use the arrow keys to advance to HIGH PWM OFFSET 253. 2. Move the product switch to MAN and the boom switches and master switch to ON. 3. Hold the INC/DEC switch to increase the RPMs. If the motor exceeds the desired RPMs, decrease the number by 10 and push INC again. 4. Decrease the 253 value displayed until the motor runs at the desired RPM. 5. Enter a number of 10 or greater. 6. Press the arrow up key to advance to LOW PWM OFFSET 1.
LOW PWM OFFSET 1	Used to set the minimum desired RPM or hydraulic output of the control valve. Used to set the zero point or shut-off point of the PWM control valve. <ol style="list-style-type: none"> 1. In the DATA MENU, use the arrow keys to advance to LOW PWM OFFSET 1. 2. Move the product switch to MAN and the boom switches and master switch to ON. 3. Hold the INC/DEC switch to decrease the RPMs until the motor stops. 4. Increase the value displayed until the motor runs at the desired RPMs. 5. Enter a number of 10 or fewer. 6. Hold the INC/DEC switch to decrease. If the motor does not stop, lower the offset number by 10 and push DEC again. 7. Press the arrow up key to advance to LOW PWM OFFSET 1.
PWM FREQUENCY 122	Used to enter the coil frequency of the PWM valve type being used. The default frequency is 122 Hz.
PRESS ENTER FOR DATA-LOCK	Sequence to activate the data lock code, the feature that prohibits data entry without the data lock code. The four-digit code must be entered within 15 seconds.

DATA LOGGER ON/OFF

The data logger uses communication strings to pass data through the serial port based on the values entered in DATA LOGGER TRIGGER VALUE and DATA LOGGER TRIGGER UNITS. Whenever a value or console switch is changed, data strings are sent by the console to the remote computer.

Some options within the Data Menu are unavailable when certain other features are active. The console data printout is not available when the data logger is on.

Remote Computer to SCS 450 Console Data Strings

All request strings begin with \$R, indicating a Raven communication string.

Rate 1 Change Request = \$R, RC, <rate_1_cal> <CR> <LF>

Calibration String Values Request = \$R, CR <CR> <LF>

Data String Request = \$R, DR <CR> <LF>

SCS 450 Console to Remote Computer Data Strings

All request strings begin with \$R, indicating a Raven communication string. The 124 value indicates the last three digits of the programmed chip part number in the console, and F is the software revision letter of the console.

- Calibration strings = \$R124F, C1, <switch_byte_1>, <switch_byte_2>, <boom_1_cal>, <boom_2_cal>, <boom_3_cal>, <boom_4_cal>, <boom_5_cal>, <boom_6_cal>, <speed_cal> <CR> <LF>
- = \$R124F, C2, <meter_cal>, <CR> <LF>
- = \$R124F, C3, <valve_cal>, <rate_1_cal>, <rate_2_cal> <CR> <LF>

Bit	Switch Byte 1	Switch Byte 2
0	boom 1	0
1	boom 2	0
2	boom 3	0
3	boom 4	rate 1
4	boom 5	rate 2
5	boom 6	0
6	0	0
7	1	1

Note: If rate 1 and rate 2 are both zero, the console is in Manual mode. For switch bytes, 0 = off and 1 = on.

- Data Strings = \$R124F, D1, <total_area>, <field_area> <CR> <LF>
- = \$R124F, D2, <total_volume>, <field_volume> <CR> <LF>
- = \$R124F, D3, <tank_volume>, <distance> <CR> <LF>
- Actual Rate = \$R124F, AR <actual_rate> <CR> <LF>
- Time/Date = \$R124F, TD, <hr:min>, <month/day/year>, <field_reference> <CR> <LF>

SELF TEST FEATURE

The self test feature simulates speed so that the system may be tested without moving. The self test feature will clear itself when vehicular motion is detected by the speed sensor. A speed cal value of 900 [230] or greater is recommended when operating in this mode.

NOTE: To prevent the self-test speed from clearing itself out automatically, disconnect the speed connector on the back of the console when radar speed sensors are used.

1. Press the SELF TEST button.
2. Enter the desired simulated speed value.
3. Verify the vehicle’s speed by pressing the SPEED button.

VOLUME/MIN RATE FAULT

The low limit value is the minimum volume per minute allowed before the valve stops closing, an alarm sounds, and the SCS 450 console displays the message "LOW LIMIT." The low limit value should be determined with all booms turned on, since this value is directly proportional to the percentage of booms that are turned on. For example, if the low limit entered is 4 and half of the total boom length is shut off, the console automatically reduces the low limit value to 2. To set the low limit value:

4. Press the VOL/MIN button until the console displays the message "SET LOW LIMIT 0."
5. Press ENTER.
6. Enter the desired low limit flow rate.
7. Press ENTER.

NOTE: The alarm may be turned off through the DATA MENU.

VOLUME/AREA RATE ALARM

The SCS 450 console alarm will sound if the actual application rate is 30% or more away from the target application rate for more than 30 seconds. The alarm may be turned off thru the DATA MENU.

LOW TANK FAULT

The SCS 450 console alarm will sound if the volume in the tank drops below the value entered into the console. The alarm will intermittently beep every 15 seconds and the display will flash "LOW LEVEL." To set the low tank alarm value:

1. Press the VOL/TANK button until the console displays the message "SET LOW LEVEL 0."
2. Press ENTER.
3. Enter the desired low tank alarm value.
4. Press ENTER.

NOTE: The alarm may be turned off by entering a value greater than or equal to the current low tank alarm value or turning off the booms. The alarm can be disabled by entering 0 as the low tank alarm value.

AUTOMATIC RATE +/-

The Automatic Rate +/- feature sets the increment at which flow is increased or decreased in the RATE 1 or RATE 2 function. Each time the INC/DEC switch is moved to INC, then the rate cal for that rate will increase by the amount entered into the console. Likewise, when the switch is moved to DEC, the rate will decrease by that value. To enter the rate change value:

1. Press RATE CAL 1 or RATE CAL 2 until the console displays the message "RATE +/- 0.0."
2. Press ENTER.
3. Enter the desired incremental value change. For example, if the rate is to change by 1, enter the value as 1.0.
4. Press ENTER.

CONTROL VALVE DELAY AND VALVE ADVANCE

The Control Valve Delay feature allows the user to set a delay between the time the booms are turned on and when the console begins to control the flow rate. The delay is active if the time between turning off the booms and turning them back on is less than 30 seconds.

The Valve Advance feature allows the user to set the amount of time (in seconds) the valve is open.

Press the SPEED CAL button until the console displays the message "CONTROL VALVE DELAY" and four digits (X X X X). The first digit is the Control Valve Delay value. The value (1 - 9) represents the number of seconds of delay in turning on automatic control. A value of 0 means that there is no delay. The third digit is the Valve Advance value. The value (1 - 9) represents the number of seconds in which the valve will be opened upon all boom sections being turned OFF in automatic control. A value of 0 means that there is no advance.

NOTE: A beginning value of 1020 is recommended for low rate situations to build up pressure when turning the master switch on. For best results, approach the headlands at consistent speeds while turning all boom sections off.

ZERO SPEED SHUT-OFF

The Zero Speed Shut-Off function is active when C-FC (fast-close valve) or C-PC (PWM close valve) is selected, and cannot be disabled. The valve will receive a decrease signal and run closed when the speed drops to 0.7 mph or less. The only way the console can operate under this speed is in the manual mode.

When the Zero Speed Shut-Off has occurred, the master switch must be turned off and back on to restart the system. If a constant speed greater than 0.7 mph is not reached within 10 seconds, the Zero Speed Shut-Off will occur again.

DATA LOCK FEATURE

The Data Lock feature prohibits data entry without the data-lock code. The four-digit code must be entered within 15 seconds.

ACTIVATE THE DATA LOCK CODE

1. Press the DATA MENU button until the message "PRESS ENTER FOR DATA-LOCK" appears on the console's display.
2. Press ENTER. The message "NEW CODE E" will appear in the display.
3. Enter the 4-digit data lock code of your choice within 15 seconds.
4. Press ENTER.

CHANGE THE DATA LOCK CODE

1. Press the DATA MENU button until the message "PRESS ENTER FOR DATA-LOCK" appears on the console's display.
2. Press ENTER. The message "OLD CODE E" will appear in the display.
3. Enter the old 4-digit data lock code within 15 seconds.
4. Press ENTER. The message "NEW CODE E" will appear in the display.
5. Enter the new 4-digit code within 15 seconds, or enter 0 to disable the Data-Lock feature.
6. Press ENTER.

ENTERING DATA IN THE DATA LOCK MODE

1. Press the button of the variable to be edited.
2. Press ENTER. A message prompting for the data-lock code will appear.
3. Enter the data-lock code. If the code is correct, E will appear on the display.
4. Enter the data to be changed as usual.

CLEAR THE DATA-LOCK CODE

The Data-Lock feature may be disabled so that a data-lock code is not required in one of two ways. The code can be changed to 0 as outlined in the “Change the Data Lock Code” on page 34, or the console can be reset, clearing the data-lock code from the system.

IMPORTANT: All calibration values entered into the SCS 450 console will be lost and must be reprogrammed.

To reset the console:

1. Turn the POWER ON/OFF switch to the OFF position.
2. Press CE and hold while turning the POWER ON/OFF switch to the ON position.

DECIMAL SHIFT FEATURE

IMPORTANT: When entering data for Rate 1 Cal and Rate 2 Cal, remember that 2 GPA [20 lit/ha] is entered as 2.0 [20.0] when the decimal is unshifted, but is entered as 2.00 [20.00] when shifted.

IMPORTANT: When shifting or unshifting the decimal place, recheck all calibration values to verify they are correct.

The Decimal Shift feature is used to increase the system’s accuracy at low application rates. The following table illustrates how shifting the decimal point can increase the system’s accuracy.

	US		Metric		Turf	
	Unshifted	Shift	Unshifted	Shift	Unshifted	Shift
Rate Display	000.0	00.00	0000	000.0	00.00	00.00
Rate Cal	000.0	00.00	0000	000.0	00.00	00.00
Tank Volume	0000	000.0	0000	000.0	000.0	000.0
Total Area	000.0	000.0	000.0	000.0	0000	0000
Total Volume	0000	000.0	0000	000.0	000.0	000.0
Field Area	000.0	000.0	000.0	000.0	0000	0000
Field Volume	0000	000.0	0000	000.0	000.0	000.0
Vol/Minute	0000	000.0	0000	000.0	000.0	000.0
Area/Hour	000.0	000.0	000.0	000.0	0000	0000
Rate +/-	000.0	00.00	0000	000.0	00.00	00.00
Low Tank Level	0000	000.0	0000	000.0	000.0	000.0
Low Vol/Min	0000	000.0	0000	000.0	000.0	000.0

SHIFT THE DECIMAL PLACE

1. Press the METER CAL button.
2. Press the SELF TEST button.
3. Enter the flow meter calibration value stamped on the identification tag.
4. Press ENTER.

UNSHIFT THE DECIMAL PLACE

1. Press the METER CAL button.
2. Enter the flow meter calibration value stamped on the identification tag.
3. Press ENTER.

CHAPTER

6

INITIAL SYSTEM SETUP AND TESTING

INITIAL SYSTEM SETUP

After all components of the system have been installed and the console has been programmed, the SCS 450 is ready to be set up. Complete the following steps to set up the SCS 450 system.

NOTE: This procedure applies only to applications of 3 GPM [11 lit/min] or greater. For flow less than 3 GPM [11 lit/min], refer to the Alternate Bypass Line System Setup section on page 38 for the alternate bypass line setup procedure.

1. Fill the tank with water only.
2. If a centrifugal pump is used, proceed to the next step. If a positive displacement pump is used, open the pressure relief valve (PRV).
3. Switch the Rate switch to MAN.
4. Switch the Power switch to ON.
5. Verify that the BOOM CAL, SPEED CAL, METER CAL, VALVE CAL, and RATE CALs have been entered correctly into the console.
6. Press the SELF TEST button.
7. Enter the machine's normal operating speed.
8. Run the pump at the normal operating RPMs.
9. If a centrifugal pump is used, proceed to the next step. If a positive displacement pump is used, set the PRV to 65 psi [450 kPa].
10. Verify that the boom valves operate and that no nozzles are plugged using the boom ON/OFF switches.
11. Switch all boom ON/OFF switches to the ON position.
12. Hold the FLOW CONTROL switch in the INC position until the pressure is at its maximum to ensure that the control valve is fully open.
13. Verify the RATE and maximum pressure.

NOTE: The pressure gauge is not supplied. A pressure gauge **MUST** be installed to properly monitor the system.

14. Adjust the agitator line hand valve until the desired agitation is reached.
15. Verify that the maximum pressure is still present.
16. Hold the FLOW CONTROL switch in the DEC position until the pressure is at its minimum to ensure that the control valve is fully closed.
17. Verify RATE and minimum pressure.

NOTE: If the RATE and minimum pressure cannot be achieved, consider modifying the plumbing into the alternate by-pass plumbing system configuration. Refer to the Alternate Bypass Line Plumbing System section on page 17.

ALTERNATE BYPASS LINE SYSTEM SETUP

NOTE: This procedure applies only to applications of less than 3 GPM [11 lit/min]. For flow of 3 GPM [11 lit/min] or greater, refer to the Initial System Setup section on page 37 for the main hose line setup procedure.

1. Fill the tank with water only.
2. Turn the Master ON/OFF switch ON.
3. Turn the boom ON/OFF switches OFF.
4. Switch the AUTO/MAN/OFF switch to MAN.
5. Turn the POWER ON/OFF switch to ON.
6. Verify that the BOOM CAL, SPEED CAL, METER CAL, VALVE CAL, and RATE CALs have been entered correctly into the console.
7. Press the SELF TEST button.
8. Enter the machine's normal operating speed.
9. With the pump not running, fully open the main line hand valve and the by-pass #1 hand valve.
10. Completely close the agitator line hand valve.
11. If a centrifugal pump is used, proceed to the next step. If a positive displacement pump is used, fully open the pressure relief valve (PRV).
12. Run the pump at normal operating RPMs.
13. If a centrifugal pump is used, proceed to the next step. If a positive displacement pump is used, complete the following steps:
 - a. Turn the Master ON/OFF switch to OFF.
 - b. Close the by-pass #1 hand valve.
 - c. Set the PRV to 65 psi [450 kPa].
 - d. Open the by-pass #1 hand valve.
 - e. Turn the Master ON/OFF switch to ON.
14. Verify that each boom valve is operational and no nozzles are plugged by operating the boom ON/OFF switches.
15. Turn all boom ON/OFF switches to ON.
16. Hold the FLOW CONTROL switch in the INC position for approximately 12 seconds. This ensures that the motorized control valve is fully closed.
17. Adjust the agitator line hand valve until the desired agitation is reached.
18. If necessary, close the main line hand valve to set the desired maximum operating pressure.

NOTE: The maximum pressure should be approximately 10 psi [70 kPa] above the normal spraying pressure. For example, if the normal spraying pressure is 30 psi [210 kPa], set the maximum pressure to 40 psi [280 kPa].

19. Hold the MAN ADJ switch in the DEC position for approximately 12 seconds. This ensures the motorized control valve is fully open.
20. Close the by-pass #1 hand valve to set the desired minimum operating pressure.

NOTE: The minimum pressure should be approximately half the normal spraying pressure. If the normal spraying pressure is 30 psi [210 kPa], set the minimum pressure to approximately 15 psi [105 kPa].

INITIAL SYSTEM FIELD TEST

NOTE: This procedure applies only to applications of 3 GPM [11 lit/min] or greater. For flow less than 3 GPM [11 lit/min], refer to the Alternate Bypass Plumbing Initial System Field Test section for the alternate bypass line testing procedure.

1. Drive down the field at the target speed with the sprayer booms off to verify the SPEED readout in the console.
2. Turn on the sprayer and booms.
3. Switch the RATE switch to RATE 1.
4. Increase or decrease the vehicle's speed by one MPH [2 km/h].

NOTE: The system should automatically adjust to the target application rate. If the system does not perform the adjustment, perform the steps in "Initial System Setup" on page 37. If the system is still not performing correctly, refer to Chapter 6 Preventative Maintenance & Troubleshooting for possible causes and corrective action.

5. At the end of each row, switch the Master ON/OFF switch to OFF to shut off the flow. This also turns off the area totalizer.
6. Verify the area covered and the volume used.

ALTERNATE BYPASS PLUMBING INITIAL SYSTEM FIELD TEST

NOTE: This procedure applies only to applications of less than 3 GPM [11 lit/min]. For flow of 3 GPM [11 lit/min] or greater, refer to the Initial System Setup section for the main hose line testing procedure.

1. Drive down the field at the target speed with the sprayer booms off to verify the SPEED readout in the console.
2. Turn on the sprayer and booms.
3. Switch the MAN/AUTO switch to AUTO.
4. Increase or decrease the vehicle's speed by 1 MPH [2 km/h].

NOTE: The system should automatically adjust to the target application rate. If the system does not perform the adjustment, perform the steps in Alternate Bypass Plumbing Initial System Field Test section on page 39. If the system is still not performing correctly, refer to Chapter 6 Preventative Maintenance & Troubleshooting for possible causes and corrective action.

5. At the end of each row, switch the Master ON/OFF switch to OFF to shut off the flow. This also turns off the area totalizer.
6. Verify the area covered and the volume used.

CHAPTER 7

PREVENTATIVE MAINTENANCE & TROUBLESHOOTING

GENERAL PREVENTATIVE MAINTENANCE

Preventative maintenance is extremely important to ensure the long life of your machine and the SCS 450 system. The following preventative maintenance measures should be taken on a regular basis:

- Flush the entire system with water after the use of suspension-type chemicals. Failure to clean the system can result in the crystallization of chemicals, causing plugs in the flow meter, lines, or nozzles.
- Flush and drain the sprayer thoroughly before storing the machine. Freezing temperatures may damage the flow meter if the water is not drained.
- Remove the console from the cab when not in use for extended periods of time.
- Disconnect the SCS 450 console before jump-starting the vehicle.
- Disconnect the SCS 450 console before welding any component of the machine.

FLOW METER MAINTENANCE

FLOW METER PREVENTATIVE MAINTENANCE AND ADJUSTMENT

	<p>! DANGER</p> <p>Thoroughly bleed the nurse tank hose and all other system lines prior to disassembling the flow meter, fittings, and hoses, especially in the case of anhydrous ammonia (NH₃).</p>
---	---

1. Thoroughly bleed the nurse tank hose and all system lines.
2. Remove the flow meter from the sprayer and flush with clean water to remove any chemicals.
3. Clean and service the turbine and turbine hub.
 - a. Remove the turbine hub and turbine from inside the flow meter.
 - b. Clean the turbine and turbine hub, removing any metal shavings or other foreign material that may have hardened on the plastic and metal parts.
 - c. Verify that the turbine blades and bearings are not worn or damaged.
 - d. Spin the turbine to confirm that it spins freely with very little drag inside the turbine hub.
4. Adjust the turbine hub if necessary. This should be done whenever the transducer assembly is replaced or the turbine stud is adjusted or replaced.
 - a. Hold the turbine hub with the turbine on the transducer.
 - b. Spin the turbine by blowing on it.
 - c. Tighten the turbine stud until the turbine stalls.

- d. Loosen the turbine stud 1/3 of a turn. The turbine should spin freely.
5. Reassemble the flow meter.
6. Use a low pressure (5 psi/34.5 kPa) burst of air to verify that the turbine spins freely. If there is a drag, loosen the hex stud on the bottom of the turbine hub 1/16 of a turn until the turbine spins freely.
7. Store the flow meter in an area that prevents it from freezing.

TESTING FLOW METER CABLES

1. Disconnect the cable from the flow sensor.

FIGURE 1. Flow Sensor Connector Cable Connection

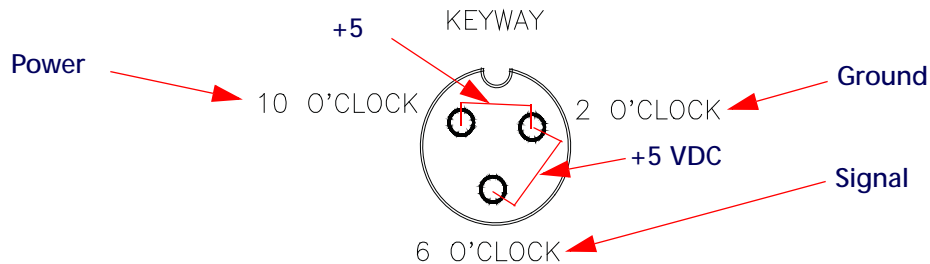

NOTE: If a +5 VDC voltage reading is not present, disconnect the speed sensor cable. If the flow reading is restored, refer to the Testing Speed Sensor Extension Cables section on page 44 to test the speed sensor extension cables.

1. Enter a METER CAL value of 1 into the console.
2. Press the TOTAL VOLUME button.
3. Place the RATE 1/RATE 2/MAN switch in the MAN position.
4. Turn the boom switches ON.
5. Create a short between the ground and signal sockets by inserting a small jumper wire or paper clip into both sockets simultaneously. Each time contact is made, the TOTAL VOLUME reading should increase in increments of 1 or more. If the TOTAL VOLUME does not increase:
 - a. Remove the section of cable closest to the console.
 - b. Repeat the ground-signal short test.
 - If the TOTAL VOLUME does not increase, replace the defective cable and repeat the ground-signal short test.
 - If the TOTAL VOLUME increases, replace the flow sensor.
6. Perform voltage checks as illustrated in the figure above.

IMPORTANT: Re-enter the original METER CAL figure after testing is complete.

RECALIBRATING THE FLOW METER

NOTE: This procedure should be performed when the tank is filled with water, not chemicals.

1. Enter a METER CAL value of 10 [38] into the console.
2. Enter a TOTAL VOLUME value of 0 into the console.
3. Turn OFF all booms.
4. Remove a boom hose and place it into a calibrated 5 gallon [19 liter] container.
5. Turn ON the boom switch for the boom hose that was removed.
6. Turn ON the Master switch and pump exactly 10 gallons [38 liters] of water. The TOTAL VOLUME readout is the new METER CAL number. This number should be within +/- 3% of the calibration number stamped on the tag of the flow meter.
7. Zero out the TOTAL VOLUME value and repeat the procedure several times to verify the accuracy of the new METER CAL value.
8. Verify the flow meter calibration.
 - a. Fill the tank with a predetermined amount of measured liquid (e.g., 250 gallons).

IMPORTANT: Do not rely on the graduation numbers molded into the applicator tank - measure the liquid.

- b. Empty the tank under normal operating conditions.
- c. Check the TANK VOLUME value. If the number displayed is different from the predetermined amount of measured liquid by more than +/- 3%, perform the following calculation:

$$\frac{\text{METER CAL} \times \text{TOTAL VOLUME}}{\text{Predetermined amount of measured liquid}} = \text{Adjusted METER CAL value}$$

FOR EXAMPLE:

METER CAL Value	=	720 [190]
TOTAL VOLUME Value	=	260 [984]
Predetermined amount of measured liquid	=	250 [946]

$$\frac{720 \times 260}{250} = 749 \text{ (English)}$$

$$\frac{[190] \times [984]}{[946]} = 198 \text{ (metric)}$$

9. Enter the adjusted METER CAL value before resuming application.

SPEED SENSOR CABLES

TESTING SPEED SENSOR EXTENSION CABLES

NOTE: Verify that the console is in the SP1 Speed Sensor mode while testing the cable.

1. Disconnect the extension cable from the speed sensor assembly cable.

FIGURE 2. Speed Sensor Connector Cable Connection

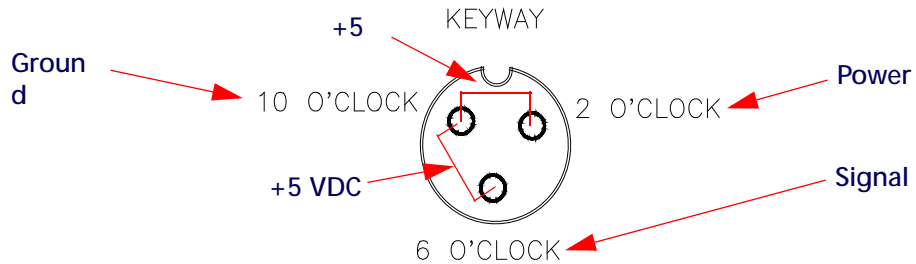

NOTE: If a +5 VDC voltage reading is not present, disconnect the flow sensor cable. If the speed reading is restored, refer to the Testing Flow Meter Cables section on page 42 to test the flow meter cables.

If the speed system is a radar-type system, the voltage between the 10 o'clock and 2 o'clock positions may read +12 VDC.

1. Enter a SPEED CAL value of 9999 into the console.
2. Press the DISTANCE button.
3. Create a short between the ground and signal sockets by inserting a small jumper wire or paper clip into both sockets simultaneously. Each time contact is made, the DISTANCE reading should increase in increments of 1 or more. If the DISTANCE does not increase:
 - a. Remove the section of cable closest to the console.
 - b. Repeat the ground-signal short test.
 - If the DISTANCE does not increase, replace the defective cable and repeat the ground-signal short test.
 - If the DISTANCE increases, replace the speed sensor.
4. Perform voltage checks as illustrated in the figure above.

IMPORTANT: Re-enter the original SPEED CAL figure after testing is complete.

TROUBLESHOOTING

CONSOLE ISSUES

Issue	Corrective Action
The console is on, but there are no lights lit up on the console.	<ol style="list-style-type: none"> 1. Check the fuse on the back of the console. 2. Check the battery connections. 3. Check the operation of the Power ON/OFF switch. 4. Return the console to the dealer to have the processor board assembly replaced.
All of the lights on the console are lit up at the same time.	Return the console to the dealer - this issue is not repairable in the field.
A digit cannot be entered via the buttons on the console.	Return the console to the dealer - this issue is not repairable in the field.
The indicator light on a key will not illuminate.	Return the console to the dealer - this issue is not repairable in the field.
The console display message flashes "CAL" whenever the vehicle's engine is started.	Check the battery voltage and connections.
The console display message flashes "CAL" whenever the Master switch is turned on or off.	Check the battery voltage and connections.
The console display message flashes "CAL" whenever the speed is changed.	Check battery voltage and connections.
The TIME function is inaccurate or drifting.	Return the console to the dealer - this issue is not repairable in the field.
Digits in the display are missing segments.	Return the console to the dealer - this issue is not repairable in the field.
The SPEED displays as "0".	<ol style="list-style-type: none"> 1. Check the speed sensor cable connector and the plug on the back of the console for loose pins. 2. Clean the pins and sockets on the speed sensor cable connections. 3. If a speed sensor extension cable is used, refer to the Testing Speed Sensor Extension Cables section on page 44. 4. If no extension cable is used, replace the speed sensor switch assembly.

Issue	Corrective Action
<p>The SPEED is inaccurate or unstable. (Wheel drive speed sensor)</p>	<ol style="list-style-type: none"> 1. Check the speed sensor. <ol style="list-style-type: none"> c. Run a speed check on a hard surface road. d. If the speed is accurate, move the speed sensor to a different wheel and perform a recheck. 2. Check the magnets. <ol style="list-style-type: none"> a. Remove one red magnet and one black magnet on the wheel. b. Reposition the remaining red and black magnets directly across from each other. c. Enter a SPEED CAL number in the console twice as large as the correct SPEED CAL number. d. Run a speed check on a hard surface road. e. Remove the two magnets and replace them with the other magnets previously removed. f. Run a speed check on a hard surface road. <ul style="list-style-type: none"> • If the speed is accurate with only one set of magnets, replace the bad set of magnets. • If the speed is inaccurate with both sets of magnets, replace the speed sensor assembly. <p>IMPORTANT: Re-enter the original SPEED CAL figure after testing is complete.</p>

RATE CONTROL ISSUES

Issue	Corrective Action
<p>The RATE displays as "0000".</p>	<ol style="list-style-type: none"> 1. Verify that the SPEED is registering correctly. If the speed is zero, refer to the "The SPEED is inaccurate or unstable" issue in the Console Issues section for the appropriate troubleshooting steps. 2. Verify that the TOTAL VOLUME is registering flow. If not, refer to the "Total volume does not register" issue in this section.
<p>The RATE is inaccurate or unstable.</p>	<ol style="list-style-type: none"> 1. Verify that all values are entered into the console correctly. 2. Verify that the SPEED is registering accurately. If it is inaccurate, refer to the "SPEED is inaccurate or unstable" issue in the Console Issues section for the appropriate troubleshooting steps. 3. In MAN (manual) operation, verify that the RATE display (GPA) holds constant. If not, refer to the "Total volume registers flow inaccurately" issue in this section. 4. In MAN operation, check the low end and high end pressure range. If pressure cannot be adjusted manually, refer to the "Total volume registers flow inaccurately" issue in this section. 5. If the problem persists, return the console to the dealer to have the processor board assembly replaced.

Issue	Corrective Action
Cannot vary the RATE in automatic or manual operation.	<ol style="list-style-type: none"> 1. Check the cabling to the motorized control valve for breaks in the line. 2. Verify the cable connections are clean. 3. Verify that there is voltage to the valve connector. <ol style="list-style-type: none"> a. Turn the Master switch ON. b. Switch the RATE 1/RATE 2/MAN switch to MAN. c. Turn the POWER switch ON. d. Manually operate the INC/DEC switch to verify voltage. 4. Verify that the valve is turning. If not, replace the motorized control valve.
The sprayer pressure is correct, but the RATE is low.	<ol style="list-style-type: none"> 1. Verify that the nozzle strainer screens and check valves are not plugged. 2. Verify that the pressure at each boom is the same. 3. Verify that all nozzles are of the correct and same orifice size. Refer to the Calculate the Rate 1 and Rate 2 Cal Values section on page 6 for the proper method to determine nozzle size.
TOTAL VOLUME does not register.	<ol style="list-style-type: none"> 1. Check the flow meter cable for breaks and shorts. Refer to the Testing Flow Meter Cables section on page 42. 2. Clean, adjust, and check the flow meter parts. Refer to the Flow Meter Preventative Maintenance and Adjustment section on page 41. 3. Replace the flow meter transducer.
TOTAL VOLUME registers the flow inaccurately.	Verify that the arrow on the flow meter is pointing in the direction of the flow. Refer to the Flow Meter Preventative Maintenance and Adjustment section on page 41 and the Recalibrating the Flow Meter section on page 43.
Motorized control valve rotates more than 1/4 turn.	Replace the motorized control valve.
There is water inside the cover of the motorized control valve.	<ol style="list-style-type: none"> 1. Replace the isolation flange assembly and coupler shaft. 2. Replace the entire motorized control valve if the PC board or motor is corroded and will not run.
Boom solenoids will not function.	<ol style="list-style-type: none"> 1. Check the cable for wires with breaks or shorts. 2. Verify that the cable connections are clean. 3. Verify that the boom switch and Master switch function properly. 4. Replace the boom valves.

CHAPTER

REPLACEMENT PARTS

8

SCS 450 SERIAL INTERFACE REPLACEMENT PARTS

ITEM	DESCRIPTION	RAVEN PART #
1	Manual Adj. Switch	412-2011-087
2	Rate1/Rate2/Manual Switch	412-2011-073
3	Power Switch	412-2011-048
4	Boom Switch	412-2003-010
5	Master Switch	412-2011-046
6	Mounting Bracket	106-0159-437
7	Mounting Knob	106-0159-438
8	Fuse Holder	510-2001-018
9	Fuse, 15 Amp.	510-1003-003
10	Console Control Cable (10 ft.)	115-0171-085
11	Flow Control Cable (6 ft.)	115-0171-086
	Flow Control Cable (12 ft.)	115-0171-129
12	Flow Meter Cable Ext. (6 ft.)	115-0159-016
	Flow Meter Cable Ext. (12 ft.)	115-0159-017
13	Flow Ext. Cable (12 ft.)	115-0159-856
	Flow Ext. Cable (24 ft.)	115-0159-857
14	Switch Cover	063-0159-734
15	1-Set Filler Spacers	117-0159-421
16	Face Plate Assembly	063-0172-024
17	Display Board Spacer	107-0159-478
18	Display Assembly	063-0171-961
19	Processor Board (Serial Interface)	064-0159-745
20	Connector Plate Assembly (Serial Interface)	063-0172-022
21	Back Assembly	063-0159-530
22	SCS 450 Console (Serial Interface)	063-0171-220

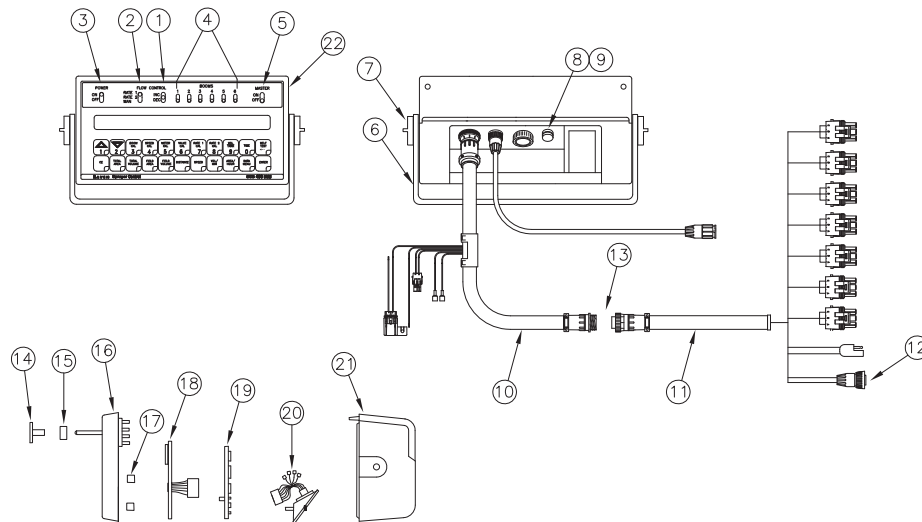

C

Console Programming and Calibration

- Console Features 24
 - Button Definitions 25
- Console Identification 23
- Console Programming 26
 - Changing Initial Console Programming 28
 - Data Entry 26
 - Initial Console Programming 26
 - Programming Additional System Data 29
- System Features 30
 - Automatic Rate +/- 33
 - Control Valve Delay and Valve Advance 33
 - Data Logger 31
 - Data Menu 30
 - Data-Lock Feature 34
 - Activating the Data-Lock Code 34
 - Decimal Shift Feature 35
 - Low Tank Fault 33
 - Self Test Feature 32
 - Volume/Area Rate Alarm 33
 - Volume/Min Rate Fault 33
 - Zero Speed Shut-Off 34

E

Electrical

- Safety 2

H

Hydraulic

- Safety 2

I

Important Safety Information

- Electrical 2
- Hydraulics 2

Initial System Setup and Testing

- Alternate Bypass Plumbing Initial System Field Test 39
- Initial Setup 37
 - Alternate Bypass Line Setup 38
- Initial System Field Test 39
 - Alternate Bypass Plumbing 39

Installation

- Battery Connections 21
- Console and Cabling 18
 - Installing the Optional Remote Switch 20
- Control Valve 16
 - Alternate Bypass Line Plumbing 16
 - Connecting the Flow Control Cable Boom Valve Connectors 17
 - Installing the Control Valve 16
- Flow Meter 15
 - Installing the Pressure Transducer 15
 - Mounting the Flow Meter 15
- Sensors 11
 - Phoenix 10 GPS Speed Sensor 14
 - Raven Radar Speed Sensor 11
 - Wheel Drive Speed Sensors 12

Introduction 1

- Calculating Machine Calibration Values 3
 - Boom Cal Value 3
 - Meter Cal 5
 - Rate 1 and Rate 2 6
 - Speed Cal Value 3
 - Raven Radar 3
 - Speedometer Drive Speed Sensors 3
 - Wheel Drive Speed Sensors 4
 - Valve Cal 5
 - Verifying Flow Rate Limits 7
- Unit Definitions and Conversions 2
 - Unit of Measure Conversions 2
 - Unit of Measure Definitions 2

P

Preventative Maintenance and Troubleshooting

- Flow Meter Maintenance 41
 - Maintenance and Adjustment 41
 - Recalibrating the Flow Meter 43
 - Testing Flow Meter Cables 42
- General Preventative Maintenance 41
- Speed Sensor Cables 44
- Troubleshooting 45
 - Console Issues 45
 - Rate Control Issues 46

RAVEN

Limited Warranty

What Does this Warranty Cover?

This warranty covers all defects in workmanship or materials in your Raven Applied Technology Division product under normal use, maintenance, and service when used for intended purpose.

How Long is the Coverage Period?

Raven Applied Technology products are covered by this warranty for 12 months from the date of retail sale. In no case will the Limited Warranty period exceed 24 months from the date the product was issued by Raven Industries Applied Technology Division. This warranty coverage applies only to the original owner and is non-transferable.

How Can I Get Service?

Bring the defective part and proof of purchase to your Raven dealer. If the dealer approves the warranty claim, the dealer will process the claim and send it to Raven Industries for final approval. The freight cost to Raven Industries will be the customer's responsibility. The Return Materials Authorization (RMA) number must appear on the box and all documentation (including proof of purchase) must be included inside the box to be sent to Raven Industries.

What Will Raven Industries Do?

Upon confirmation of the warranty claim, Raven Industries will (at our discretion) repair or replace the defective product and pay for the standard return freight, regardless of the inbound shipping method. Expedited freight is available at the customer's expense.

What is not Covered by this Warranty?

Raven Industries will not assume any expense or liability for repairs made outside our facilities without written consent. Raven Industries is not responsible for damage to any associated equipment or products and will not be liable for loss of profit, labor, or other damages. The obligation of this warranty is in lieu of all other warranties, expressed or implied, and no person or organization is authorized to assume any liability for Raven Industries.

Damages caused by normal wear and tear, misuse, abuse, neglect, accident, or improper installation and maintenance are not covered by this warranty.



Extended Warranty

What Does this Warranty Cover?

This warranty covers all defects in workmanship or materials in your Raven Applied Technology Division product under normal use, maintenance, and service when used for intended purpose.

Do I Need to Register My Product to Qualify for the Extended Warranty?

Yes. Products/systems must be registered within 30 days of retail sale to receive coverage under the Extended Warranty. If the component does not have a serial tag, the kit it came in must be registered instead.

Where Can I Register My Product for the Extended Warranty?

To register, go online to www.ravenhelp.com and select Product Registration.

How Long is the Extended Warranty Coverage Period?

Raven Applied Technology products that have been registered online are covered for an additional 12 months beyond the Limited Warranty for a total coverage period of 24 months from the date of retail sale. In no case will the Extended Warranty period exceed 36 months from the date the product was issued by Raven Industries Applied Technology Division. This Extended Warranty coverage applies only to the original owner and is non-transferable.

How Can I Get Service?

Bring the defective part and proof of purchase to your Raven dealer. If the dealer approves the warranty claim, the dealer will process the claim and send it to Raven Industries for final approval. The freight cost to Raven Industries will be the customer's responsibility. The Return Materials Authorization (RMA) number must appear on the box and all documentation (including proof of purchase) must be included inside the box to be sent to Raven Industries. In addition, the words "Extended Warranty" must appear on the box and all documentation if the failure is between 12 and 24 months from the retail sale.

What Will Raven Industries Do?

Upon confirmation of the product's registration for the Extended Warranty and the claim itself, Raven Industries will (at our discretion) repair or replace the defective product and pay for the standard return freight, regardless of the inbound shipping method. Expedited freight is available at the customer's expense.

What is Not Covered by the Extended Warranty?

Raven Industries will not assume any expense or liability for repairs made outside our facilities without written consent. Raven Industries is not responsible for damage to any associated equipment or products and will not be liable for loss of profit, labor, or other damages. Cables, hoses, software enhancements, and remanufactured items are not covered by this Extended Warranty. The obligation of this warranty is in lieu of all other warranties, expressed or implied, and no person or organization is authorized to assume any liability for Raven Industries.

Damages caused by normal wear and tear, misuse, abuse, neglect, accident, or improper installation and maintenance are not covered by this warranty.