

RAVEN

# AutoBoom™ Installation Manual



**Hardi Eagle**

## ***Disclaimer***

---

While every effort has been made to ensure the accuracy of this document, Raven Industries assumes no responsibility for omissions and errors. Nor is any liability assumed for damages resulting from the use of information contained herein.

Raven Industries shall not be responsible or liable for incidental or consequential damages or a loss of anticipated benefits or profits, work stoppage or loss, or impairment of data arising out of the use, or inability to use, this system or any of its components. Raven Industries shall not be held responsible for any modifications or repairs made outside our facilities, nor damages resulting from inadequate maintenance of this system.

As with all wireless and satellite signals, several factors may affect the availability and accuracy of wireless and satellite navigation and correction services (e.g. GPS, GNSS, SBAS, etc.). Therefore, Raven Industries cannot guarantee the accuracy, integrity, continuity, or availability of these services and cannot guarantee the ability to use Raven systems, or products used as components of systems, which rely upon the reception of these signals or availability of these services. Raven Industries accepts no responsibility for the use of any of these signals or services for other than the stated purpose.

<b>Chapter 1</b>	<b><i>Important Safety Information</i></b>	<b>1</b>
	Hydraulic Safety	2
	Electrical Safety	2
<b>Chapter 2</b>	<b><i>Introduction</i></b>	<b>3</b>
	Preparing for Installation	4
	Recommendations	4
	Point of Reference	4
	Hydraulic Fittings	4
<b>Chapter 3</b>	<b><i>PowerGlide Plus</i></b>	<b>7</b>
	PowerGlide Plus Kit Contents	7
	Install the PowerGlide Plus Hydraulic System	12
	Remove the Orifice Fittings	12
	Install Fittings on the AutoBoom Valve	15
	Mount the AutoBoom Valve	16
	Install the Pressure and Tank Hoses	17
	Install the Left and Right Cylinder Hoses	18
	Remove the Left and Right Down Hoses	18
	PowerGlide Plus Hydraulic Schematic	20
	Install the Gauge Wheels	21
	Gauge Wheel Mounting Locations	21
	Mount the Gauge Wheels	21
	Install the PowerGlide Plus Wiring	22
	Install the AutoBoom Node	22
	Connect the Harness to the Boom Function Controls	23
	Connect the Harness Cable to the Implement Extension Tee - Gen II Cable Only	24
	Connect the Harness Cable to the Controller Cable - Gen I Cable Only	25
	Connect the Controller (If Applicable) - Gen I Cable Only	25
	Connect the Field Computer (If Applicable)	25
	Connect the Power Leads	25
	PowerGlide Plus Wiring Schematic	26
	Gen I Cabling	26
	Gen II Cabling	27
<b>Chapter 4</b>	<b><i>UltraGlide</i></b>	<b>29</b>
	UltraGlide Kit Contents	29
	Install the UltraGlide Hydraulic System	35
	Install Fittings on the AutoBoom Valve	36
	Mount the AutoBoom Valve	37
	Install the Pressure and Tank Hoses	38
	Install the Left and Right Cylinder Hoses	39

---

Remove the Left and Right Down Hoses .....	39
UltraGlide Hydraulic Schematic .....	41
Install the UltraGlide Sensors .....	42
Boom Sensor Mounting Locations .....	42
Mount the Center Rack Sensor .....	43
Connect the Sensor Cables .....	43
Install the Gauge Wheels - Optional .....	44
Gauge Wheel Mounting Locations .....	44
Mount the Gauge Wheels .....	44
Install the UltraGlide Wiring .....	45
Install the AutoBoom Node .....	45
Connect the Harness to the Boom Function Controls .....	46
Install the Center Rack Control .....	48
Connect the Harness Cable to the Sensors .....	48
Connect the Harness Cable to the Implement Extension Tee - Gen II Cable Only .....	48
Connect the Harness Cable to the Controller Cable - Gen I Cable Only .....	49
Connect the Controller (If Applicable) - Gen I Cable Only .....	49
Connect the Field Computer (If Applicable) .....	49
Connect the Power Leads .....	49
UltraGlide Wiring Schematic .....	50
Gen I Cabling .....	50
Gen II Cabling .....	51
<b>Chapter 5    <i>Replacement Parts</i> .....</b>	<b>53</b>
Valve Blocks .....	53
Wheels .....	54
Sensors .....	54

---

## CHAPTER

# 1

# *Important Safety Information*

---

## NOTICE

Read this manual and the operation and safety instructions included with your implement and/or controller carefully before installing the AutoBoom™ system.

- Follow all safety information presented within this manual.
- If you require assistance with any portion of the installation or service of your Raven equipment, contact your local Raven dealer for support.
- Follow all safety labels affixed to the AutoBoom system components. Be sure to keep safety labels in good condition and replace any missing or damaged labels. To obtain replacements for missing or damaged safety labels, contact your local Raven dealer.

When operating the machine after installing AutoBoom, observe the following safety measures:

- Be alert and aware of surroundings.
- Do not operate AutoBoom or any agricultural equipment while under the influence of alcohol or an illegal substance.
- Remain in the operator's position in the machine at all times when AutoBoom is engaged.
- Disable AutoBoom when exiting from the operator's seat and machine.
- Do not drive the machine with AutoBoom enabled on any public road.
- Determine and remain a safe working distance from other individuals. The operator is responsible for disabling AutoBoom when the safe working distance has diminished.
- Ensure AutoBoom is disabled prior to starting any maintenance work on AutoBoom or the machine.

## WARNING

- When starting the machine for the first time after installing AutoBoom, be sure that all persons stand clear, in case a hose has not been properly tightened.
- The machine must remain stationary and switched off, with the booms unfolded and supported, during installation or maintenance.

 **CAUTION**

---

## *Hydraulic Safety*

- Raven Industries recommends that appropriate protective equipment must be worn at all times when working on the hydraulic system.
- Never attempt to work on a hydraulic system with the equipment running. Care should always be taken when opening a system that has been previously pressurized.
- When disconnecting the hydraulic hoses or purging is required, be aware that the hydraulic fluid may be extremely hot and under high pressure. Caution must be exercised.
- Any work performed on the hydraulic system must be done in accordance with the machine manufacturer's approved maintenance instructions.
- When installing AutoBoom hydraulics or performing diagnostics, maintenance, or routine service, ensure that precautions are taken to prevent any foreign material or contaminants from introduced into the machine's hydraulic system. Objects or materials that are able to bypass the machine's hydraulic filtration system will reduce performance and possibly damage the AutoBoom hydraulic valve.

---

## *Electrical Safety*

- Always verify that the power leads are connected to the correct polarity as marked. Reversing the power leads could cause severe damage to the equipment.
- Ensure that the power cable is the last cable to be connected.

---

CHAPTER

2

*Introduction*

Congratulations on your purchase of the Raven AutoBoom system! This system is designed to provide automated boom height adjustment for agricultural equipment.

This manual applies to the following machines. For future reference, write your serial number in the space below.

**MAKE:** Hardi  
**MODEL:** Eagle  
**YEAR:**  
**SERIAL NUMBER:**

**FIGURE 1. Hardi Eagle**



**Note:** *This manual contains the installation instructions for the PowerGlide Plus and UltraGlide systems. Be sure to identify which system you have and follow only the instructions for that system.*

# *Preparing for Installation*

Before installing AutoBoom, park the machine where the ground is level, clean, and dry. Leave the machine turned off for the duration of the installation process.

During the installation process, follow good safety practices. Be sure to carefully read the instructions in this manual as you complete the installation process.

## Recommendations

Raven Industries recommends the following best practices before installing or operating the AutoBoom system for the first time, at the start of the season, or when moving the AutoBoom system to another machine:

- Ensure the machine's hydraulic filters have been recently changed and there are no issues with the machine's hydraulic system (e.g., pump issues, faulty hydraulic motors, fine metal deposits in the hydraulic hoses, etc.).
- Operate each of the machine's boom hydraulic functions (i.e., tilt, fold, center rack, tongue extension, or other hydraulic valve functions) three times to ensure the machine's hydraulic valve is using fresh oil and debris is flushed from the hydraulic hoses, valves, and filters.
- Upon installation of the AutoBoom system, operate the boom and center rack raise/lower functions through the machine's manual control functions first before operating them via the AutoBoom controller/field computer to ensure the hydraulic system has been installed correctly and air is released from the system.

Raven Industries recommends the following best practices when installing the AutoBoom system.

- Use part numbers to identify the parts.
- Do not remove the plastic wrap from a part until it is necessary for installation.
- Do not remove plastic caps from a part until it is necessary for installation.

## Tools Needed

The following tools are recommended for installation of the AutoBoom system:

- SAE standard-sized wrenches
- Cable ties
- Set of tools

## Point of Reference

The instructions in this manual assume that you are standing behind the machine, looking toward the cab.

---

# *Hydraulic Fittings*

This manual may reference the following types of hydraulic fittings:

- SAE O-ring fittings
- ORFS (O-Ring Face Seal) fittings
- JIC fittings



SAE O-ring fitting



ORFS fitting



JIC fitting (M)





CHAPTER





3

*PowerGlide Plus*







*PowerGlide Plus Kit Contents*

This section contains a list of the components that are included in the PowerGlide Plus AutoBoom kit. Before beginning the AutoBoom installation, compare the items in the AutoBoom kit with the components on this list. If you have questions about the kit, contact your Raven dealer.

**TABLE 1. PowerGlide Plus Installation Kit (P/N 117-0231-026)**

Picture	Item Description	Part Number	Qty.
Not Pictured	Manual - Hardi Eagle AutoBoom Installation	016-0230-026	1
	Valve - PowerGlide Plus/UltraGlide AutoBoom	063-0131-126	1
	Plate - Hydraulic Block Mounting	107-0171-802	1
	Cable - Single Weatherpack Boom Sense Adapter	115-0171-790	1
	Cable - PowerGlide/PowerGlide Plus/ UltraGlide Extension	115-0230-008	1
	Cable - Pin A Signal Metripack Boom Sense Adapter	115-0230-013	2

**TABLE 1. PowerGlide Plus Installation Kit (P/N 117-0231-026)**

Picture	Item Description	Part Number	Qty.
	Cable - 3-Pin Din Pin 2 Signal Boom Sense Adapter	115-0230-080	1
	U-Bolt - 2-9/16" W x 3-1/2" L x 3/8" Thread	107-0171-616	2
	Bolt - 5/16"-18 x 7/8" Hex Bolt	311-0052-104	4
	Bolt - 3/8"-16 Zinc Hex	311-0054-106	3 (1 extra)
	Nut - 3/8"-16 Zinc Flanged Lock	312-1001-164	7 (1 extra)
	Washer - 5/16" Zinc Plated Lock	313-1000-019	4



**TABLE 2. Hydraulic Kit (P/N 117-0134-026)**

Picture	Item Description	Part Number	Qty.
	Fitting - 3/4" JIC M/M/F Swivel Run Tee Adapter	333-0012-039	1
	Fitting - 9/16" JIC M/F 90° Swivel Elbow	333-0012-042	4
	Fitting - 9/16" JIC (M) to 9/16" SAE O-Ring (M) Straight Adapter	333-0012-045	2
	Fitting - 9/16" JIC (M) to 3/4" SAE O-Ring (M) Straight Adapter	333-0012-046	2

TABLE 2. Hydraulic Kit (P/N 117-0134-026)

Picture	Item Description	Part Number	Qty.
	Fitting - 3/4" JIC M/F 90° Swivel Elbow	333-0012-064	1
	Fitting - 3/4" SAE O-Ring (M) to 3/4" JIC (M) Straight Adapter	333-0012-093	1
	Fitting - 1/4" BSPP (F) Cap	333-0012-190	2
	Fitting - 9/16" JIC (M) to 3/8" BSPP (M) Straight Adapter	333-0012-192	2
	Fitting - 3/8" NPT Breather	333-0012-196	2
	Fitting - 9/16" SAE O-Ring (M) to 3/8" BSPP (M) Straight Adapter	333-0012-260	2
	Fitting - 3/8" BSPP (F) to 3/8" BSPP (F) Straight Adapter	333-0012-261	2
	Fitting - 3/8" BSPP Bonded Seal	333-0012-271	2
	Fitting - 3/8" NPT (F) to 3/8" BSPP (M) Straight Adapter	333-0012-303	2
	Hydraulic Hose - 9/16" JIC 90° (F) to 9/16" JIC (F) - 56"	214-1000-266	2
	Hydraulic Hose - 9/16" JIC (F) to 1/2" NPT (M) - 360"	214-1000-286	1

**TABLE 2. Hydraulic Kit (P/N 117-0134-026)**

Picture	Item Description	Part Number	Qty.
	Hydraulic Hose - 3/4" JIC (F) to 1/2" NPT (M) - 360"	214-1000-287	1
	Hydraulic Hose - 9/16" JIC (F) to 3/4" JIC (F) - 12"	214-1000-596	1

**TABLE 3. PowerGlide Plus Wheel Kit (P/N 117-0133-026)**



Picture	Item Description	Part Number	Qty.
	Axle Assembly - Right Cushioned AutoBoom	063-0131-585	1
	Axle Assembly - Left Cushioned AutoBoom	063-0131-590	1
	Bracket - Hardi Eagle Receiver Weldment	116-0159-534	2
	Bracket - Hub Retainer	107-0171-617	2
	Wheel	322-0131-008	2
	U-Bolt - 2-1/16" W x 3" L x 3/8" Thread	107-0171-609	4
	U-Bolt - 1-9/16" W x 2-1/2" L x 3/8" Thread	107-0171-611	4
	Bolt - 1/2"-13 x 1-1/2" SS Hex	311-0058-186	4

TABLE 3. PowerGlide Plus Wheel Kit (P/N 117-0133-026)



Picture	Item Description	Part Number	Qty.
	Nut - 1/2"-13 Zinc Hex	312-1001-043	4
	Nut - 3/8"-16 Zinc Flanged Lock	312-1001-164	16

TABLE 4. Gen I PowerGlide Plus Wiring Kit (P/N 117-0137-023)







Picture	Item Description	Part Number	Qty.
Not Pictured	Manual - AutoBoom Calibration & Operation	016-0130-062	1
	Node - PowerGlide Plus AutoBoom	063-0130-010	1
	Cable - Harness	115-0230-045	1
	Cable - Power/CAN	115-0230-007	1

TABLE 5. Gen II PowerGlide Plus Wiring Kit (P/N 117-5130-001)

Picture	Item Description	Part Number	Qty.
Not Pictured	Manual - AutoBoom Calibration & Operation	016-0130-062	1
	Node - PowerGlide Plus AutoBoom	063-0130-010	1
	Cable - PowerGlide Plus/UltraGlide with CAN/Power Tee AutoBoom	115-0230-085	1

**Important:** In addition to the Gen II wiring kit components listed above, an implement extension tee cable is required for the operation of the PowerGlide Plus AutoBoom system. For available cables and ordering information, contact your local Raven dealer.

## Install the PowerGlide Plus Hydraulic System

	<p><b>WARNING</b></p> <p>The machine must remain stationary and switched off, with the booms unfolded and supported, during installation or maintenance.</p>
---	--

	<p><b>CAUTION</b></p> <p>When installing AutoBoom hydraulics or performing diagnostics, maintenance, or routine service, ensure precautions are taken to prevent any foreign material from being introduced into the machine's hydraulic system.</p> <p>Objects or materials that are able to bypass the machine's hydraulic filtration system will reduce performance and possibly cause damage to the AutoBoom hydraulic valve.</p>
--	---

	<p><b>NOTICE</b></p> <p>The appearance of the AutoBoom hydraulic valve may vary slightly from the images contained in this manual. However, the fittings, hose connections, and cable connections remain the same.</p>
---	--

### Remove the Orifice Fittings

Before populating the hydraulic fittings on the AutoBoom valve, it is necessary to remove orifice fittings from the valve in the PowerGlide Plus system. Failure to remove these fittings from the valve will restrict the down speed of the booms when the system is enabled.



**FIGURE 1. Port 3A and 3B Location**

1. Locate Ports 3A and 3B on the AutoBoom valve.

**FIGURE 2. Coil Removed from the AutoBoom Valve**

2. Remove the coils from the solenoids near Ports 3A and 3B to gain easy access to those ports.

**FIGURE 3. Port Plugs Removed from the AutoBoom Valve**

3. Use an Allen wrench to remove the plugs from Ports 3A and 3B.

FIGURE 4. Orifice Fitting Removed from the AutoBoom Valve



Orifice Fitting  
Removed - Keep for  
Future Use

4. Remove the orifice fittings from Ports 3A and 3B.

**Important:** Tip the AutoBoom valve on its side and use the Allen wrench to remove the orifice from the cavity, taking care not to let the fitting fall into the valve.

FIGURE 5. Port Plug Reinstalled on the AutoBoom Valve



5. Use the Allen wrench to reinstall the port plugs on Ports 3A and 3B of the AutoBoom valve.

FIGURE 6. Coil Reinstalled on the AutoBoom Valve



6. Reinstall the coils on the solenoids of the AutoBoom valve.

## Install Fittings on the AutoBoom Valve

Before mounting the AutoBoom valve on the machine, install the proper fittings on the valve. This prepares the valve for installation and simplifies the hose connection process later in the procedure. Refer to the following figure and table to install the fittings in the appropriate ports of the AutoBoom valve.

**FIGURE 7. Fittings Installed on the AutoBoom Valve**

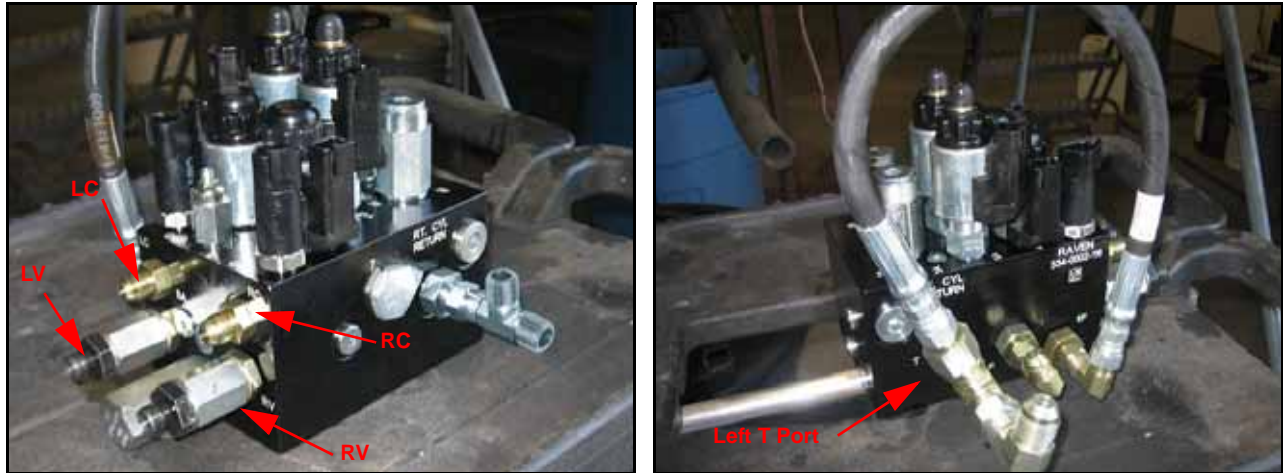

Fitting	Part Number	Port
Fitting - 9/16" JIC (M) to 9/16" SAE O-Ring (M) Straight Adapter	333-0012-045	LC, RC
Fitting - 9/16" SAE O-Ring (M) to 3/8" BSPP (M) Straight Adapter	333-0012-260	LV, RV
Fitting - 3/8" BSPP Bonded Seal	333-0012-271	LV, RV
Fitting - 3/8" BSPP (F) to 3/8" BSPP (F) Straight Adapter	333-0012-261	LV, RV
Fitting - 9/16" JIC (M) to 3/4" SAE O-Ring (M) Straight Adapter	333-0012-046	P, EF
Fitting - 9/16" JIC M/F 90° Swivel Elbow	333-0012-042	P, EF, LC, RC
Fitting - 3/4" SAE O-Ring (M) to 3/4" JIC (M) Straight Adapter	333-0012-093	Left T (port next to P)
Fitting - 3/4" JIC M/M/F Swivel Run Tee Adapter	333-0012-039	Left T (port next to P)
Fitting - 3/4" JIC M/F 90° Swivel Elbow	333-0012-064	Left T (port next to P)

## Mount the AutoBoom Valve

**FIGURE 8. AutoBoom Valve Mounted on the Valve Mounting Plate**

---

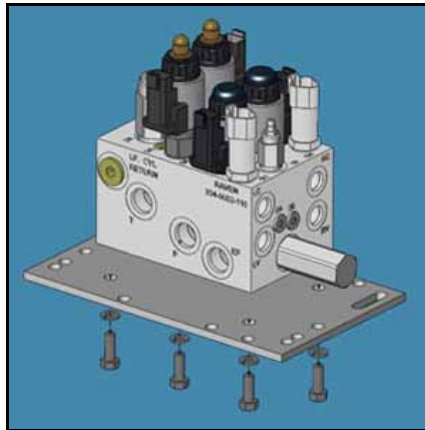

1. Secure the AutoBoom valve (P/N 063-0131-126) to the mounting plate (P/N 107-0171-802) using four 5/16"-18 x 7/8" hex bolts (P/N 311-0052-104) and four 5/16" lock washers (P/N 313-1000-019).

**FIGURE 9. AutoBoom Valve Mounted to the Center Rack**

---



2. Secure the mounting plate to the machine's center rack using two 2-9/16" W x 3-1/2" L x 3/8" thread U-bolts (P/N 107-0171-616) and four 3/8"-16 zinc flanged lock nuts (P/N 312-1001-164).

## Install the Pressure and Tank Hoses



**⚠ WARNING**

Hydraulics are under pressure. Care should always be taken with a system that has been pressurized. When disconnecting or purging hydraulic hoses, be aware that the hydraulic fluid within the machine's system may be extremely hot and under high pressure.



**⚠ CAUTION**

When installing AutoBoom hydraulics or performing diagnostics, maintenance, or routine service, ensure precautions are taken to prevent any foreign material or contaminants from being introduced into the machine's hydraulic system.

Objects or materials that are able to bypass the machine's hydraulic filtration system will reduce performance and possibly cause damage to the AutoBoom hydraulic valve.

**Note:** The tractor's pressure and tank connections require an adapter fitting appropriate for the tractor being used. This fitting is not supplied in the AutoBoom installation kit.

**FIGURE 10. Pressure and Tank Hoses Installed**

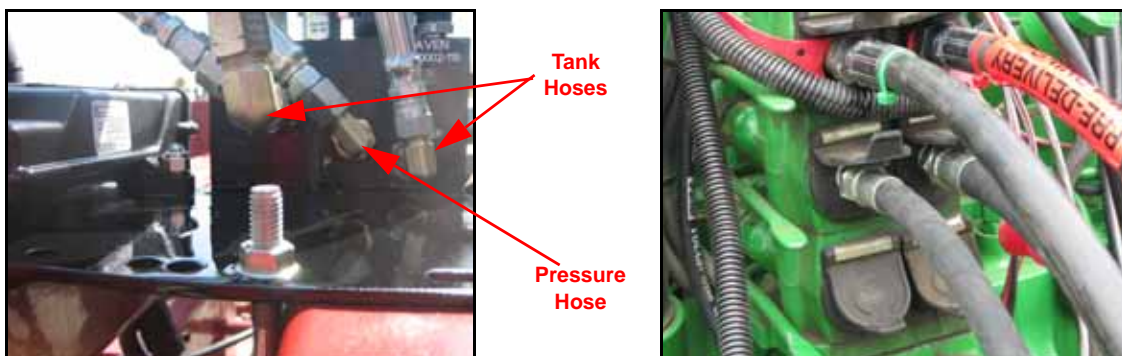

1. Install the 9/16" end of the supplied hydraulic hose (P/N 214-1000-286) on the installed elbow fitting in Port P of the AutoBoom valve.
2. Route the installed hydraulic hose to the back of the tractor and connect it to the tractor's pressure port.
3. Install the 3/4" end of the supplied hydraulic hose (P/N 214-1000-596) on the 90° end of the installed tee fitting in the left T Port on the AutoBoom valve.
4. Connect the other end of the installed hydraulic hose to the installed fittings in Port EF of the AutoBoom valve.
5. Install the 3/4" end of the supplied hydraulic hose (P/N 214-1000-287) on the installed elbow fitting in Port T of the AutoBoom valve.
6. Route the installed hydraulic hose to the back of the tractor and connect it to the tractor's tank port.



## Install the Left and Right Cylinder Hoses

FIGURE 11. Cylinder Hoses Installed



1. Disconnect the machine's cylinder up hoses (ports D and F on the hydraulic valve) from the rod-end of the machine's tilt cylinders.
2. Remove the orifice fittings from the cylinders.
3. Install the orifice fittings on the installed fittings in Ports LV and RV of the AutoBoom valve.
4. Connect the machine's left cylinder hose (port F) to the installed fittings in Port LV of the AutoBoom valve.
5. Connect the machine's right cylinder hose (port D) to the installed fittings in Port RV of the AutoBoom valve.
6. Install a 9/16" JIC (M) to 3/8" BSPP (M) straight adapter fitting (P/N 333-0012-192) in the rod-end of the machine's left tilt cylinder.
7. Install the straight end of the supplied hydraulic hose (P/N 214-1000-266) on the installed fittings in Port LC of the AutoBoom valve.
8. Connect the 90° end of the installed hydraulic hose to the installed fitting in the machine's left tilt cylinder.
9. Install a 9/16" JIC (M) to 3/8" BSPP (M) straight adapter fitting (P/N 333-0012-192) in the rod-end of the machine's right tilt cylinder.
10. Install the straight end of the supplied hydraulic hose (P/N 214-1000-266) on the installed fittings in Port RC of the AutoBoom valve.
11. Connect the 90° end of the installed hydraulic hose to the installed fitting in the machine's right tilt cylinder.

## Remove the Left and Right Down Hoses

FIGURE 12. Machine's Hydraulic Valve



1. Disconnect the machine's cylinder down hoses (ports C and E) from the machine's hydraulic valve.
2. Install 1/4" BSPP (F) cap fittings (P/N 333-0012-190) on the open cylinder fittings of the machine's hydraulic valve.
3. Remove the cylinder down fittings from the base-end of the tilt cylinders.
4. Install the 3/8" NPT (F) to 3/8" BSPP (M) straight adapter fittings (P/N 333-0012-303) in the base-end of the tilt cylinders.
5. Install the 3/8" NPT breather fittings (P/N 333-0012-196) in the installed adapter fittings.
6. Install the 1/4" BSPP (F) cap fittings (P/N 333-0012-190) in the C and E ports on the machine's valve.

# PowerGlide Plus Hydraulic Schematic

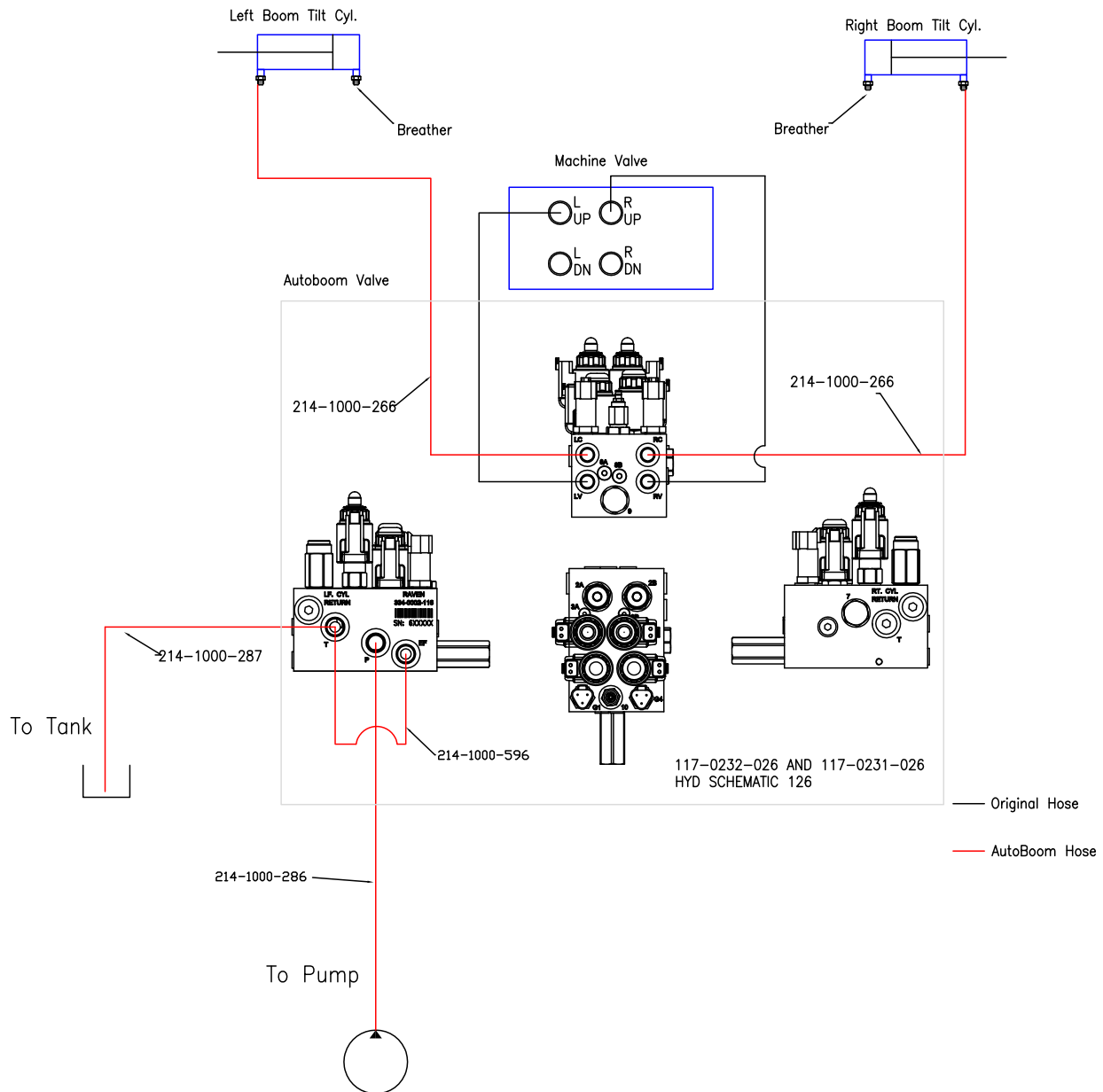



## Install the Gauge Wheels

### Gauge Wheel Mounting Locations

Wheel mounting locations may be influenced by the boom configuration. Determine the appropriate location for mounting the wheels on the boom, ensuring the wheels will not interfere with or be damaged while folding or unfolding the booms. The wheels should be mounted outside of the boom fold, but inside of the boom breakaway.

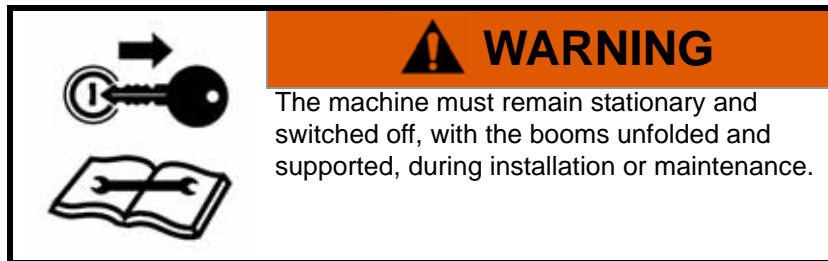

### Mount the Gauge Wheels

**Note:** The appearance of the wheel axles may vary.

FIGURE 13. Gauge Wheel Installed



1. Remove the nuts from the left wheel axle (P/N 063-0131-590).
2. Place the wheel (P/N 322-0131-008) on the wheel axle.
3. Align and place the hub retainer bracket (P/N 107-0171-617) over the wheel.
4. Reinstall the lug nuts on the wheel axle to secure the wheel and hub retainer bracket.
5. Mount the receiver bracket (P/N 116-0159-534) to the front of the left boom using two 2-1/16" W x 3" L x 3/8" thread U-bolts (P/N 107-0171-609), two 1-9/16" W x 2-1/2" L x 3/8" thread U-bolts (P/N 107-0171-611), and eight 3/8"-16 zinc flanged lock nuts (P/N 312-1001-164).
6. Insert the wheel axle into the receiver bracket, positioning it so that the bottom of the wheel touches the ground (or nearly so) and the wheel faces away from the machine.
7. Secure the gauge wheel assembly in the wheel mounting bracket by installing two 1/2"-13 x 1-1/2" SS hex bolts (P/N 311-0058-186) and two 1/2"-13 zinc hex nuts (P/N 312-1001-043).
8. Repeat the steps above to install the right wheel.

## Install the PowerGlide Plus Wiring

### Wiring Connections

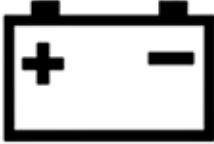
	<b>⚠ CAUTION</b>
Always connect the power cable as the last step in the wiring process and verify that the power leads are connected with the correct polarity. Reversing power leads can cause severe damage to the equipment.	

For wiring connections made outside the cab, apply dielectric silicone grease (P/N 222-0000-006) generously on both the male and female ends of the connectors. Application of the grease will prevent corrosion to the pins and wires.

### Install the AutoBoom Node

FIGURE 14. AutoBoom Node Installed



1. Mount the AutoBoom node (P/N 063-0130-010) to the hydraulic block mounting plate next to the AutoBoom valve using two 3/8"-16 zinc hex bolts (P/N 311-0054-106) and two 3/8"-16 zinc flanged lock nuts (P/N 312-1001-164).
2. Insert the large, rectangular node connectors on the harness cable (P/N 115-0230-045) into the correct ports of the AutoBoom node.
3. Tighten the bolts on the node connectors to secure the connections.

## Connect the Harness to the Boom Function Controls

1. Locate the Left Press and Right Press connectors on the harness cable (P/N 115-0230-045 or 115-0230-085).
2. Route the connectors to the AutoBoom valve (P/N 063-0131-126).
3. Connect the Left Press connector to Port G1 on the AutoBoom valve.
4. Connect the Right Press connector to Port G4 on the AutoBoom valve.
5. Locate the Left Solenoid and Right Solenoid connectors on the harness cable.
6. Connect the Left Solenoid connector to Port 4A on the AutoBoom valve.
7. Connect the Right Solenoid connector to Port 4B on the AutoBoom valve.
8. Locate the Left Prop and Right Prop connectors on the harness cable.
9. Connect the Left Prop connector to Port 5A on the AutoBoom valve.
10. Connect the Right Prop connector to Port 13A on the AutoBoom valve.

**FIGURE 15. Directional Valve Boom Sense Adapter Cable Installed**

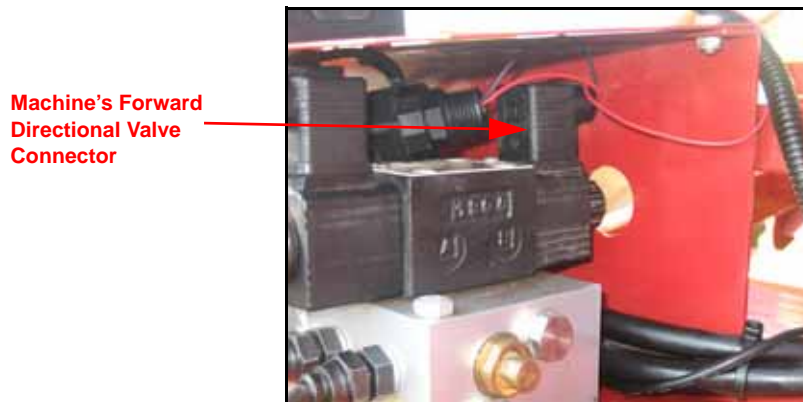

11. Locate the machine's directional valve.
12. Disconnect the machine's forward directional valve connector from the directional valve.
13. Install the 3-pin din pin 2 signal boom sense adapter cable (P/N 115-0230-080) on the machine's forward directional valve connector.

**FIGURE 16. Single Weatherpack Boom Sense Adapter Cable Installed**



14. Install the single weatherpack boom sense adapter cable (P/N 115-0171-790) on the installed 3-pin din boom sense adapter cable.

**FIGURE 17. Machine's Up Cylinder Wiring**

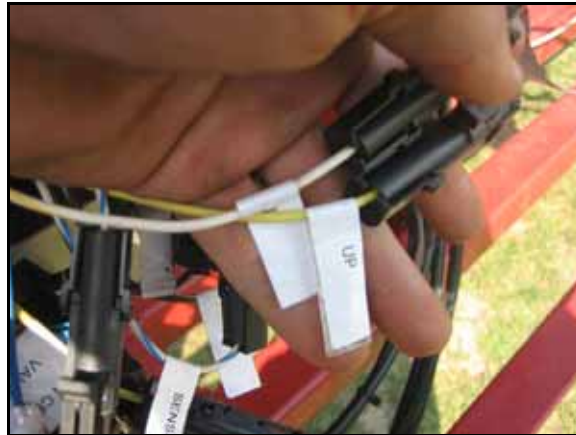

15. Connect the Up connectors on the AutoBoom harness to the Up connectors on the installed single weatherpack boom sense adapter cable (P/N 115-0171-790).

**FIGURE 18. Machine's Down Cylinder Wiring**

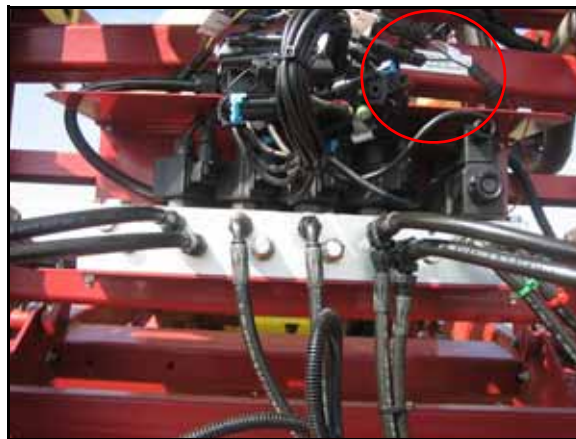

16. Install the metripack pin A signal boom sense adapter cables (P/N 115-0230-013) between the machine's cylinder Up coils and the connectors.
17. Connect the cable connectors to the Down connectors on the AutoBoom harness to the installed boom sense adapter cables.

## Connect the Harness Cable to the Implement Extension Tee - Gen II Cable Only

1. Route the harness cable (P/N 115-0230-085) toward the implement extension tee cable.
2. Connect the harness cable to the To Node connector.
3. Remove the terminator from the machine's chassis harness or the standalone console harness.
4. Install the terminator on the remaining open end of the implement extension tee cable.
5. Refer to the wiring schematic (beginning on page 26) appropriate for the machine's configuration to route the implement extension tee cable.
6. Connect the implement extension tee cable to the location determined in the step above.

---

## Connect the Harness Cable to the Controller Cable - Gen I Cable Only

1. Route the harness cable (P/N 115-0230-045) toward the machine's cab.
2. Connect the harness cable to the controller cable (P/N 115-0230-007).
3. Tighten the connector screw cap to secure the connection.

**Note:** *Be sure to allow enough slack in the harness cable to allow for boom racking.*

## Connect the Controller (If Applicable) - Gen I Cable Only

1. Route the controller cable (P/N 115-0230-007) into the right side of the machine's cab.
2. Locate the two controller connectors and connect them to the AutoBoom controller (P/N 063-0130-021).

**Note:** *The AutoBoom controller should be mounted in the machine's cab so that the machine's operator has easy access to it.*

## Connect the Field Computer (If Applicable)

Refer to the Installation & Operation Manual and the appropriate wiring schematic beginning on page 26 for installation and wiring instructions for your specific field computer.

## Connect the Power Leads

1. Locate the power cable that has the red and white power leads at one end.
2. Disconnect the machine's connectors from the battery terminals.
3. Install the red power lead on the positive battery terminal and reinstall the machine's battery connector.
4. Install the white power lead on the negative battery terminal and reinstall the machine's battery connector.













CHAPTER

4

*UltraGlide*

*UltraGlide Kit Contents*

This section contains a list of the components that are included in the UltraGlide AutoBoom kit. Before beginning the AutoBoom installation, compare the items in the AutoBoom kit with the components on this list. If you have questions about the kit, contact your Raven dealer.

**TABLE 1. UltraGlide Installation Kit (P/N 117-0232-026)**

Picture	Item Description	Part Number	Qty.
Not Pictured	Manual - Hardi Eagle AutoBoom Installation	016-0230-026	1
	Valve - PowerGlide Plus/UltraGlide AutoBoom	063-0131-126	1
	Plate - Hydraulic Block Mounting	107-0171-802	1
	Sensor - Right Ultrasonic	063-0130-012	1
	Sensor - Left Ultrasonic	063-0130-014	1
	Sensor - Center Ultrasonic	063-0130-018	1

TABLE 1. UltraGlide Installation Kit (P/N 117-0232-026)









Picture	Item Description	Part Number	Qty.
	Cable - Single Weatherpack Boom Sense Adapter	115-0171-790	1
	Cable - PowerGlide/PowerGlide Plus/ UltraGlide Extension	115-0230-008	1
	Cable - Pin A Signal Metripack Boom Sense Adapter	115-0230-013	2
	Cable - Pin A Signal Weatherpack Center Rack Control Boom Sense Adapter	115-0230-035	2
	Cable - Center Rack Control 14' Extension	115-0230-066	1
	Cable - 3-Pin Din Pin 2 Signal Boom Sense Adapter	115-0230-080	1
	U-Bolt - 2-1/16" W x 3" L x 3/8" Thread	107-0171-609	6
	U-Bolt - 2-9/16" W x 3-1/2" L x 3/8" Thread	107-0171-616	2
	Bolt - 5/16"-18 x 7/8" Hex	311-0052-104	4
	Bolt - 3/8"-16 Zinc Hex	311-0054-106	3 (1 extra)

TABLE 1. UltraGlide Installation Kit (P/N 117-0232-026)

Picture	Item Description	Part Number	Qty.
	Nut - 3/8"-16 Zinc Flanged Lock	312-1001-164	19 (1 extra)
	Washer - 5/16" Zinc Plated Lock	313-1000-019	4

TABLE 2. Hydraulic Kit (P/N 117-0134-026)

Picture	Item Description	Part Number	Qty.
	Fitting - 3/4" JIC M/M/F Swivel Run Tee Adapter	333-0012-039	1
	Fitting - 9/16" JIC M/F 90° Swivel Elbow	333-0012-042	4
	Fitting - 9/16" JIC (M) to 9/16" SAE O-Ring (M) Straight Adapter	333-0012-045	2
	Fitting - 9/16" JIC (M) to 3/4" SAE O-Ring (M) Straight Adapter	333-0012-046	2
	Fitting - 3/4" JIC M/F 90° Swivel Elbow	333-0012-064	1
	Fitting - 3/4" SAE O-Ring (M) to 3/4" JIC (M) Straight Adapter	333-0012-093	1
	Fitting - 1/4" BSPP (F) Cap	333-0012-190	2
	Fitting - 9/16" JIC (M) to 3/8" BSPP (M) Straight Adapter	333-0012-192	2

TABLE 2. Hydraulic Kit (P/N 117-0134-026)

Picture	Item Description	Part Number	Qty.
	Fitting - 3/8" NPT Breather	333-0012-196	2
	Fitting - 9/16" SAE O-Ring (M) to 3/8" BSPP (M) Straight Adapter	333-0012-260	2
	Fitting - 3/8" BSPP (F) to 3/8" BSPP (F) Straight Adapter	333-0012-261	2
	Fitting - 3/8" BSPP Bonded Seal	333-0012-271	2
	Fitting - 3/8" NPT (F) to 3/8" BSPP (M) Straight Adapter	333-0012-303	2
	Hydraulic Hose - 9/16" JIC 90° (F) to 9/16" JIC (F) - 56"	214-1000-266	2
	Hydraulic Hose - 9/16" JIC (F) to 1/2" NPT (M) - 360"	214-1000-286	1
	Hydraulic Hose - 3/4" JIC (F) to 1/2" NPT (M) - 360"	214-1000-287	1
	Hydraulic Hose - 9/16" JIC (F) to 3/4" JIC (F) - 12"	214-1000-596	1

TABLE 3. Ultrasonic Sensor Bracket Installation Kit (P/N 117-0131-082)





Picture	Item Description	Part Number	Qty.
Not Pictured	Sheet - AutoBoom Sensor Extension	016-0130-070	1
	Bracket - 12" S-Type AutoBoom Sensor	063-0131-592	2
	Bolt - 5/16"-18 x 1-1/4" Hex	311-0052-106	2
	Nut - 5/16"-18 Nylon Insert Lock	312-4000-059	2
	Washer - 5/16" Zinc Flat	313-2300-012	4

TABLE 4. Optional Wheel Kit (P/N 117-0133-026)

Picture	Item Description	Part Number	Qty.
	Axle Assembly - Right Cushioned AutoBoom	063-0131-585	1
	Axle Assembly - Left Cushioned AutoBoom	063-0131-590	1
	Bracket - Hardi Eagle Receiver Weldment	116-0159-534	2
	Bracket - Hub Retainer	107-0171-617	2
	Wheel	322-0131-008	2

**TABLE 4. Optional Wheel Kit (P/N 117-0133-026)**

Picture	Item Description	Part Number	Qty.
	U-Bolt - 2-1/16" W x 3" L x 3/8" Thread	107-0171-609	4
	U-Bolt - 1-9/16" W x 2-1/2" L x 3/8" Thread	107-0171-611	4
	Bolt - 1/2"-13 x 1-1/2" SS Hex	311-0058-186	4
	Nut - 1/2"-13 Zinc Hex	312-1001-043	4
	Nut - 3/8"-16 Zinc Flanged Lock	312-1001-164	16

**TABLE 5. Gen I UltraGlide Wiring Kit (P/N 117-0137-024)**









Picture	Item Description	Part Number	Qty.
Not Pictured	Manual - AutoBoom Calibration & Operation	016-0130-062	1
	Node - UltraGlide AutoBoom	063-0130-013	1
	Cable - Sensor	115-0171-527	2
	Cable - Harness	115-0230-045	1
	Cable - Power/CAN Controller	115-0230-007	1

TABLE 6. Gen II UltraGlide Wiring Kit (P/N 117-5130-003)

Picture	Item Description	Part Number	Qty.
Not Pictured	Manual - AutoBoom Calibration & Operation	016-0130-062	1
	Node - UltraGlide AutoBoom	063-0130-013	1
	Cable - Sensor	115-0171-527	2
	Cable - PowerGlide Plus/UltraGlide with CAN/Power Tee AutoBoom	115-0230-085	1

**Important:** In addition to the Gen II wiring kit components listed above, an implement extension tee cable is required for the operation of the UltraGlide AutoBoom system. For available cables and ordering information, contact your local Raven dealer.

## Install the UltraGlide Hydraulic System



**⚠ WARNING**

The machine must remain stationary and switched off, with the booms unfolded and supported, during installation or maintenance.



**⚠ CAUTION**

When installing AutoBoom hydraulics or performing diagnostics, maintenance, or routine service, ensure precautions are taken to prevent any foreign material from being introduced into the machine's hydraulic system.

Objects or materials that are able to bypass the machine's hydraulic filtration system will reduce performance and possibly cause damage to the AutoBoom hydraulic valve.



**NOTICE**

The appearance of the AutoBoom hydraulic valve may vary slightly from the images contained in this manual. However, the fittings, hose connections, and cable connections remain the same.

## Install Fittings on the AutoBoom Valve

Before mounting the AutoBoom valve on the machine, install the proper fittings on the valve. This prepares the valve for installation and simplifies the hose connection process later in the procedure. Refer to the following figure and table to install the fittings in the appropriate ports of the AutoBoom valve.

**FIGURE 1. Fittings Installed on the AutoBoom Valve**

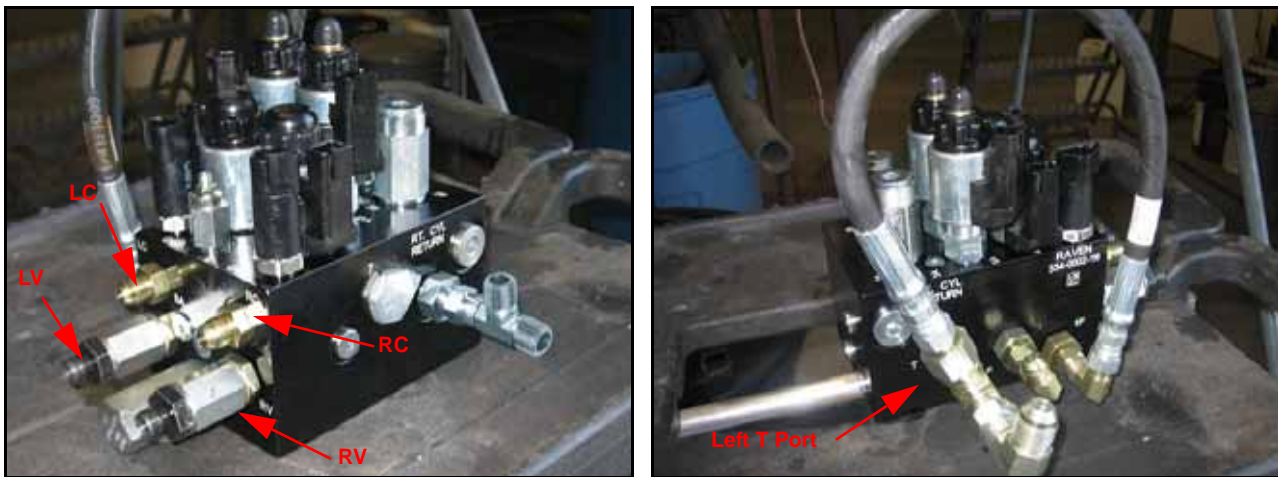

Fitting	Part Number	Port
Fitting - 9/16" JIC (M) to 9/16" SAE O-Ring (M) Straight Adapter	333-0012-045	LC, RC
Fitting - 9/16" SAE O-Ring (M) to 3/8" BSPP (M) Straight Adapter	333-0012-260	LV, RV
Fitting - 3/8" BSPP Bonded Seal	333-0012-271	LV, RV
Fitting - 3/8" BSPP (F) to 3/8" BSPP (F) Straight Adapter	333-0012-261	LV, RV
Fitting - 9/16" JIC (M) to 3/4" SAE O-Ring (M) Straight Adapter	333-0012-046	P, EF
Fitting - 9/16" JIC M/F 90° Swivel Elbow	333-0012-042	P, EF, LC, RC



Fitting	Part Number	Port
Fitting - 3/4" SAE O-Ring (M) to 3/4" JIC (M) Straight Adapter	333-0012-093	Left T (port next to P)
Fitting - 3/4" JIC M/M/F Swivel Run Tee Adapter	333-0012-039	Left T (port next to P)
Fitting - 3/4" JIC M/F 90° Swivel Elbow	333-0012-064	Left T (port next to P)

## Mount the AutoBoom Valve

**FIGURE 2. AutoBoom Valve Mounted on the Valve Mounting Plate**

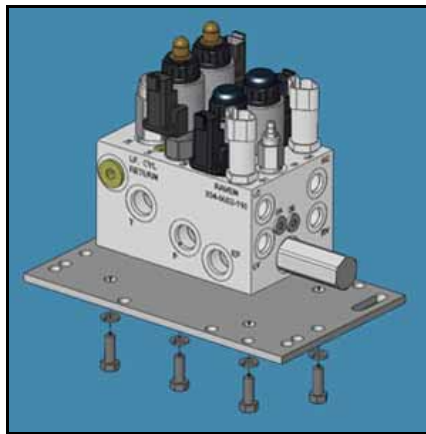

1. Secure the AutoBoom valve (P/N 063-0131-126) to the mounting plate (P/N 107-0171-802) using four 5/16"-18 x 7/8" hex bolts (P/N 311-0052-104) and four 5/16" lock washers (P/N 313-1000-019).

**FIGURE 3. AutoBoom Valve Mounted to the Center Rack**



2. Secure the mounting plate to the machine's center rack using two 2-9/16" W x 3-1/2" L x 3/8" thread U-bolts (P/N 107-0171-616) and four 3/8"-16 zinc flanged lock nuts (P/N 312-1001-164).

## Install the Pressure and Tank Hoses

	<p><b>⚠ WARNING</b></p> <p>Hydraulics are under pressure. Care should always be taken with a system that has been pressurized. When disconnecting or purging hydraulic hoses, be aware that the hydraulic fluid within the machine's system may be extremely hot and under high pressure.</p>
---	---

	<p><b>⚠ CAUTION</b></p> <p>When installing AutoBoom hydraulics or performing diagnostics, maintenance, or routine service, ensure precautions are taken to prevent any foreign material or contaminants from being introduced into the machine's hydraulic system.</p> <p>Objects or materials that are able to bypass the machine's hydraulic filtration system will reduce performance and possibly cause damage to the AutoBoom hydraulic valve.</p>
---	---

**Note:** *The tractor's pressure and tank connections require an adapter fitting appropriate for the tractor being used. This fitting is not supplied in the AutoBoom installation kit.*

FIGURE 4. Pressure and Tank Hoses Installed

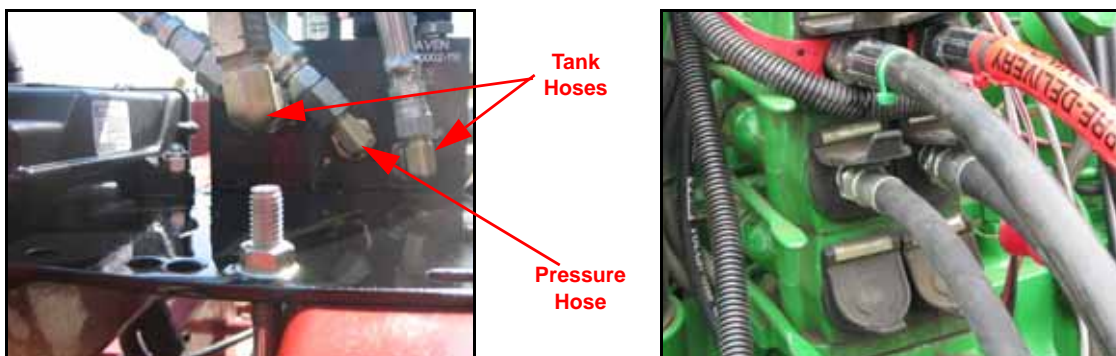

1. Install the 9/16" end of the supplied hydraulic hose (P/N 214-1000-286) on the installed elbow fitting in Port P of the AutoBoom valve.
2. Route the installed hydraulic hose to the back of the tractor and connect it to the tractor's pressure port.
3. Install the 3/4" end of the supplied hydraulic hose (P/N 214-1000-596) on the 90° end of the installed tee fitting in the left T Port on the AutoBoom valve.
4. Connect the other end of the installed hydraulic hose to the installed fittings in Port EF of the AutoBoom valve.
5. Install the 3/4" end of the supplied hydraulic hose (P/N 214-1000-287) on the installed elbow fitting in Port T of the AutoBoom valve.
6. Route the installed hydraulic hose to the back of the tractor and connect it to the tractor's tank port.

## Install the Left and Right Cylinder Hoses

**FIGURE 5. Cylinder Hoses Installed**



1. Disconnect the machine's cylinder up hoses (ports D and F on the hydraulic valve) from the rod-end of the machine's tilt cylinders.
2. Remove the orifice fittings from the cylinders.
3. Install the orifice fittings on the installed fittings in Ports LV and RV of the AutoBoom valve.
4. Connect the machine's left cylinder hose (port F) to the installed fittings in Port LV of the AutoBoom valve.
5. Connect the machine's right cylinder hose (port D) to the installed fittings in Port RV of the AutoBoom valve.
6. Install a 9/16" JIC (M) to 3/8" BSPP (M) straight adapter fitting (P/N 333-0012-192) in the rod-end of the machine's left tilt cylinder.
7. Install the straight end of the supplied hydraulic hose (P/N 214-1000-266) on the installed fittings in Port LC of the AutoBoom valve.
8. Connect the 90° end of the installed hydraulic hose to the installed fitting in the machine's left tilt cylinder.
9. Install a 9/16" JIC (M) to 3/8" BSPP (M) straight adapter fitting (P/N 333-0012-192) in the rod-end of the machine's right tilt cylinder.
10. Install the straight end of the supplied hydraulic hose (P/N 214-1000-266) on the installed fittings in Port RC of the AutoBoom valve.
11. Connect the 90° end of the installed hydraulic hose to the installed fitting in the machine's right tilt cylinder.

## Remove the Left and Right Down Hoses

**FIGURE 6. Machine's Hydraulic Valve**



1. Disconnect the machine's cylinder down hoses (ports C and E) from the machine's hydraulic valve.
2. Install 1/4" BSPP (F) cap fittings (P/N 333-0012-190) on the open cylinder fittings of the machine's hydraulic valve.
3. Remove the cylinder down fittings from the base-end of the tilt cylinders.
4. Install the 3/8" NPT (F) to 3/8" BSPP (M) straight adapter fittings (P/N 333-0012-303) in the base-end of the tilt cylinders.
5. Install the 3/8" NPT breather fittings (P/N 333-0012-196) in the installed adapter fittings.
6. Install the 1/4" BSPP (F) cap fittings (P/N 333-0012-190) in the C and E ports on the machine's valve.

# UltraGlide Hydraulic Schematic

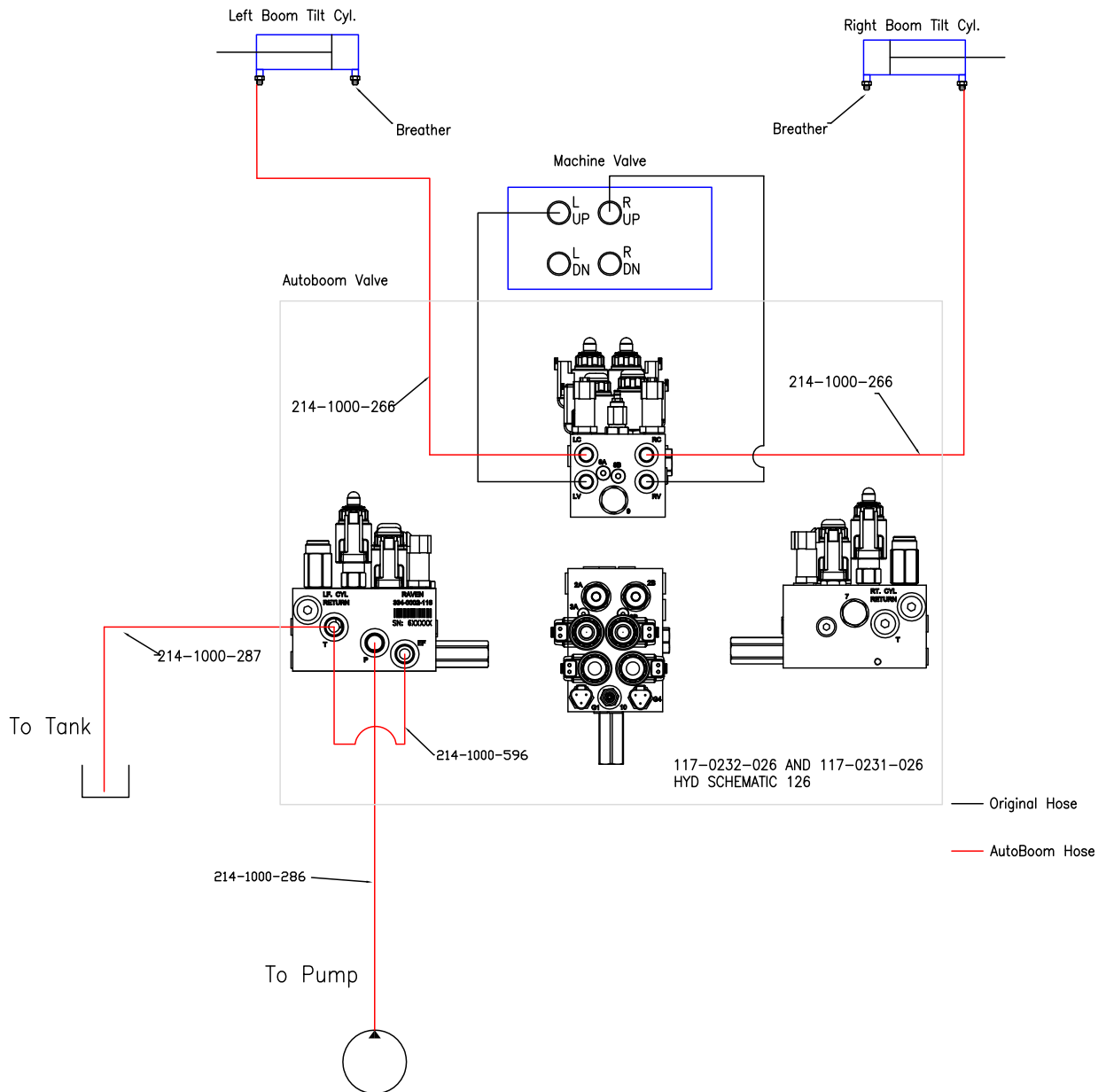

## Install the UltraGlide Sensors

### Boom Sensor Mounting Locations

Sensor mounting locations may be influenced by the boom configuration. If an object enters the sensor's blind range unexpectedly, a false echo return to the sensor could occur, causing the boom to drop and the sensor or boom to be damaged. To ensure optimal operation of the UltraGlide system and to protect the sprayer boom, the sensors should be mounted on the front side of the boom, 8 - 10" above the lowest hanging part of the boom.

FIGURE 7. Illustration of Sensor's Blind Range

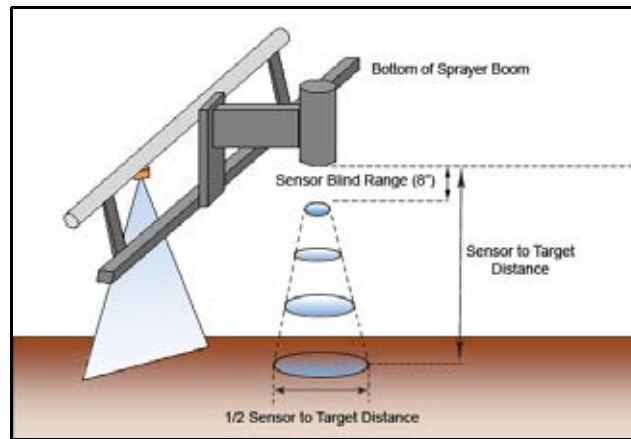

### Mount the Boom Sensors

	<p><b>⚠ WARNING</b></p> <p>The machine must remain stationary and switched off, with the booms unfolded and supported, during installation or maintenance.</p>
---	--

FIGURE 8. Mounted Boom Sensor





1. Locate the left and right ultrasonic sensors (P/N 063-0130-012 and 063-0130-014) in the AutoBoom installation kit.
2. Remove the sensor from the existing plastic arm.
3. Install the sensors on the 12" S-type sensor arms (P/N 063-0131-592) using the supplied 5/16"-18 x 1-1/4" bolts (P/N 311-0052-106), 5/16"-18 nylon insert lock nuts (P/N 312-4000-059) and 5/16" zinc flat washers (P/N 313-2300-012).
4. Secure the left sensor (P/N 063-0130-014) to the front of the left boom using two 2-1/16" W x 3" L x 3/8" thread U-bolts (P/N 107-0171-609) and four 3/8"-16 zinc flanged lock nuts (P/N 312-1001-164).
5. Tighten the nuts to ensure the sensor is mounted securely.
6. Repeat the steps above to mount the remaining boom sensor(s).

## Mount the Center Rack Sensor

FIGURE 9. Center Rack Sensor



1. Mount the center sensor (P/N 063-0130-018) to the machine's center rack using two 2-1/16" W x 3" L x 3/8" thread U-bolts (P/N 107-0171-609) and four 3/8"-16 zinc flanged lock nuts (P/N 312-1001-164).

## Connect the Sensor Cables

1. Connect the left sensor cable (P/N 115-0171-527) to the connector on the outer left sensor.
2. Route the left sensor cable toward the AutoBoom valve.
3. Loop and tie-off any excess cable, allowing enough cable for boom folding and extension.
4. Repeat the steps above to connect the remaining sensor cables.

**Note:** The sensor cables will be connected to the AutoBoom in the wiring phase of installation.

## Install the Gauge Wheels - Optional

### Gauge Wheel Mounting Locations

Wheel mounting locations may be influenced by the boom configuration. Determine an appropriate location for mounting a wheel on the boom, ensuring the wheels will not interfere with or be damaged by folding or unfolding the booms. The wheel should be mounted outside of the boom fold, but inside the boom breakaway.

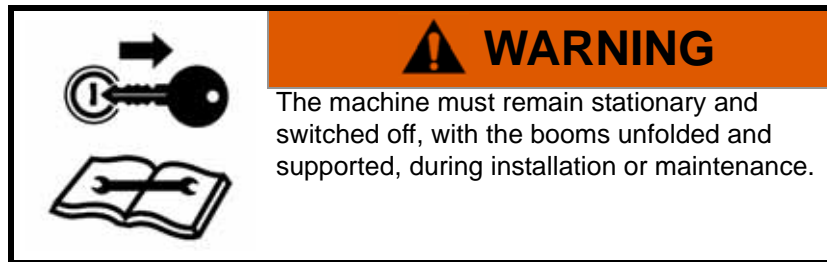

### Mount the Gauge Wheels

**Note:** The appearance of the wheel axles may vary.

FIGURE 10. Gauge Wheel Installed



1. Remove the nuts from the left wheel axle (P/N 063-0131-590).
2. Place the wheel (P/N 322-0131-008) on the wheel axle.
3. Align and place the hub retainer bracket (P/N 107-0171-617) over the wheel.
4. Reinstall the lug nuts on the wheel axle to secure the wheel and hub retainer bracket.
5. Mount the receiver bracket (P/N 116-0159-534) to the front of the left boom using two 2-1/16" W x 3" L x 3/8" thread U-bolts (P/N 107-0171-609), two 1-9/16" W x 2-1/2" L x 3/8" thread U-bolts (P/N 107-0171-611), and eight 3/8"-16 zinc flanged lock nuts (P/N 312-1001-164).
6. Insert the wheel axle into the receiver bracket, positioning it so that the bottom of the wheel touches the ground (or nearly so) and the wheel faces away from the machine.
7. Secure the gauge wheel assembly in the wheel mounting bracket by installing two 1/2"-13 x 1-1/2" SS hex bolts (P/N 311-0058-186) and two 1/2"-13 zinc hex nuts (P/N 312-1001-043).
8. Repeat the steps above to install the right wheel.



## Install the UltraGlide Wiring

### Wiring Connections

	<p><b>⚠ CAUTION</b></p> <p>Always connect the power cable as the last step in the wiring process and verify that the power leads are connected with the correct polarity. Reversing power leads can cause severe damage to the equipment.</p>
---	---

For wiring connections made outside the cab, apply dielectric silicone grease (P/N 222-0000-006) generously on both the male and female ends of the connectors. Application of the grease will prevent corrosion to the pins and wires.

### Install the AutoBoom Node

FIGURE 11. AutoBoom Node Installed



1. Mount the AutoBoom node (P/N 063-0130-013) to the hydraulic block mounting plate next to the AutoBoom valve using two 3/8"-16 zinc hex bolts (P/N 311-0054-106) and two 3/8"-16 zinc flanged lock nuts (P/N 312-1001-164).
2. Insert the large, rectangular node connectors on the harness cable (P/N 115-0230-045 or 115-0230-085) into the correct ports of the AutoBoom node.
3. Tighten the bolts on the node connectors to secure the connections.

## Connect the Harness to the Boom Function Controls

1. Locate the Left Press and Right Press connectors on the harness cable (P/N 115-0230-045 or 115-0230-085).
2. Route the connectors to the AutoBoom valve (P/N 063-0131-126).
3. Connect the Left Press connector to Port G1 on the AutoBoom valve.
4. Connect the Right Press connector to Port G4 on the AutoBoom valve.
5. Locate the Left Solenoid and Right Solenoid connectors on the harness cable.
6. Connect the Left Solenoid connector to Port 4A on the AutoBoom valve.
7. Connect the Right Solenoid connector to Port 4B on the AutoBoom valve.
8. Locate the Left Prop and Right Prop connectors on the harness cable.
9. Connect the Left Prop connector to Port 5A on the AutoBoom valve.
10. Connect the Right Prop connector to Port 13A on the AutoBoom valve.

**FIGURE 12. Directional Valve Boom Sense Adapter Cable Installed**

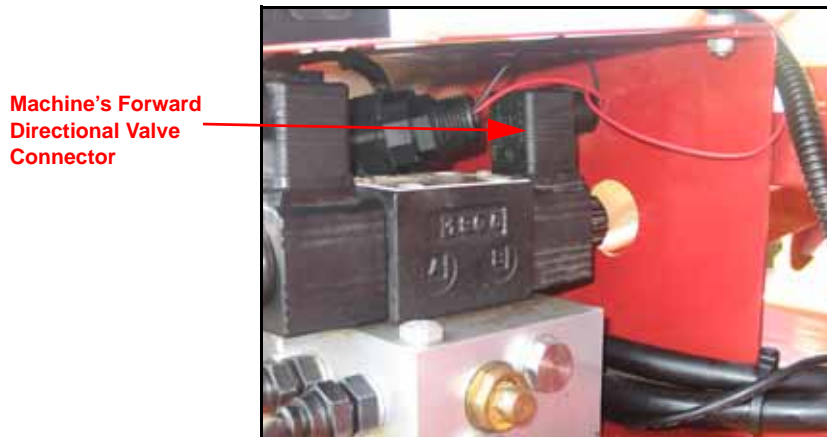

11. Locate the machine's directional valve.
12. Disconnect the machine's forward directional valve connector from the directional valve.
13. Install the 3-pin din pin 2 signal boom sense adapter cable (P/N 115-0230-080) on the machine's forward directional valve connector.

**FIGURE 13. Single Weatherpack Boom Sense Adapter Cable Installed**



14. Install the single weatherpack boom sense adapter cable (P/N 115-0171-790) on the installed 3-pin din boom sense adapter cable.

**FIGURE 14. Machine's Up Cylinder Wiring**

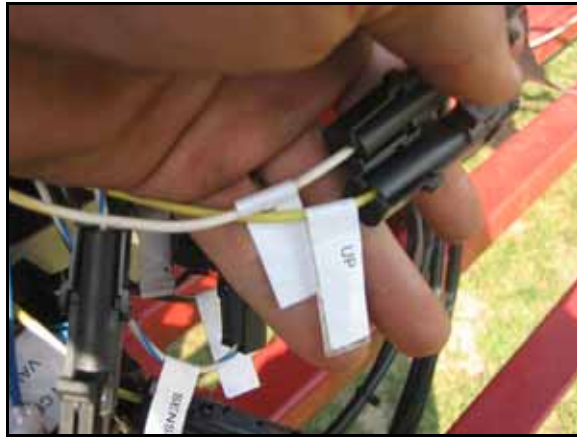

15. Connect the Up connectors on the AutoBoom harness to the installed single weatherpack boom sense adapter cable (P/N 115-0171-790).

**FIGURE 15. Machine's Down Cylinder Wiring**

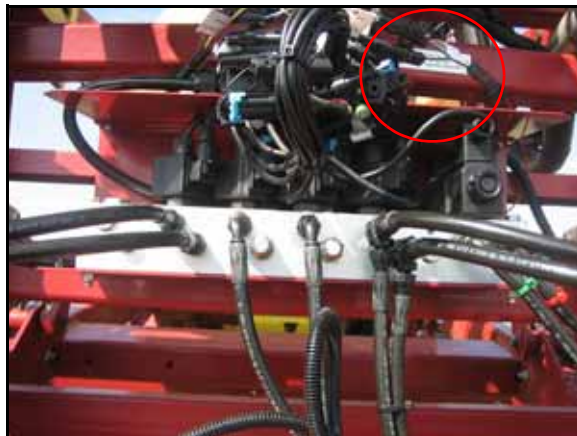

16. Install the metripack pin A signal boom sense adapter cables (P/N 115-0230-013) between the machine's cylinder Up coils and the connectors.
17. Connect the cable connectors to the Down connectors on the AutoBoom harness to the installed boom sense adapter cables.

## Install the Center Rack Control

FIGURE 16. Center Rack Control Connections



1. Locate the machine's center rack control valve.
2. Disconnect the machine's connections from the center rack control valve.
3. Install pin A signal metripack center rack control AutoBoom adapter cables (P/N 115-0230-035) on the machine's center rack control coils.
4. Connect the machine's connections to the installed center rack control adapter cables.
5. Connect the 14' center rack control extension cable (P/N 115-0230-066) to the installed center rack control adapter cables.
6. Route the installed center rack control extension cable to the AutoBoom harness cable.
7. Connect the extension cable to the Center Solenoid Up Sense and Control connections on the AutoBoom harness cable (P/N 115-0230-045 or 115-0230-085).

### Connect the Harness Cable to the Sensors

1. Locate the Center Sensor connector on the AutoBoom harness cable.
2. Connect the Center Sensor connector to the installed center sensor (P/N 063-0130-018).
3. Locate the Left Outer Sensor connector on the AutoBoom harness cable.
4. Connect the Left Outer Sensor connector to the installed left sensor cable (P/N 115-0171-527).
5. Locate the Right Outer Sensor connector on the AutoBoom harness cable.
6. Connect the Right Outer Sensor connector to the installed right sensor cable.
7. If optional inside boom sensors are installed, repeat the steps above to connect the sensors.

### Connect the Harness Cable to the Implement Extension Tee - Gen II Cable Only

1. Route the harness cable (P/N 115-0230-085) toward the implement extension tee cable.
2. Connect the harness cable to the To Node connector.
3. Remove the terminator from the machine's chassis harness or the standalone console harness.

4. Install the terminator on the remaining open end of the implement extension tee cable.
5. Refer to the wiring schematic (beginning on page 50) appropriate for the machine's configuration to route the implement extension tee cable.
6. Connect the implement extension tee cable to the location determined in the step above.

## Connect the Harness Cable to the Controller Cable - Gen I Cable Only

1. Route the harness cable (P/N 115-0230-045) toward the machine's cab.
2. Connect the harness cable to the controller cable (P/N 115-0230-007).
3. Tighten the connector screw cap to secure the connection.

**Note:** *Be sure to allow enough slack in the harness cable to allow for boom racking.*

## Connect the Controller (If Applicable) - Gen I Cable Only

1. Route the controller cable (P/N 115-0230-007) into the right side of the machine's cab.
2. Locate the two controller connectors and connect them to the AutoBoom controller (P/N 063-0130-021).

**Note:** *The AutoBoom controller should be mounted in the machine's cab so that the machine's operator has easy access to it.*

## Connect the Field Computer (If Applicable)

Refer to the Installation & Operation Manual and the appropriate wiring schematic beginning on page 50 for installation and wiring instructions for your specific field computer.

## Connect the Power Leads

1. Locate the power cable that has the red and white power leads at one end.
2. Disconnect the machine's connectors from the battery terminals.
3. Install the red power lead on the positive battery terminal and reinstall the machine's battery connector.
4. Install the white power lead on the negative battery terminal and reinstall the machine's battery connector.





# Gen II Cabling

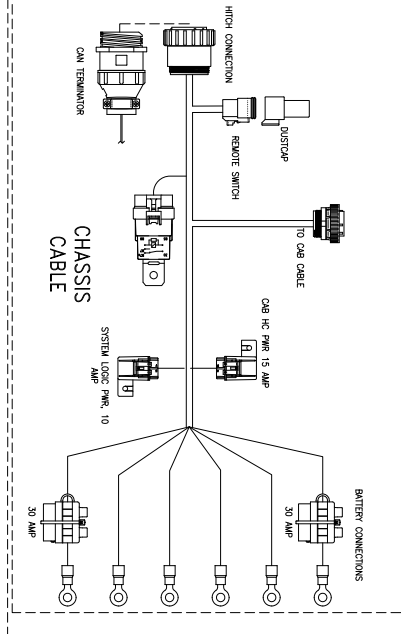
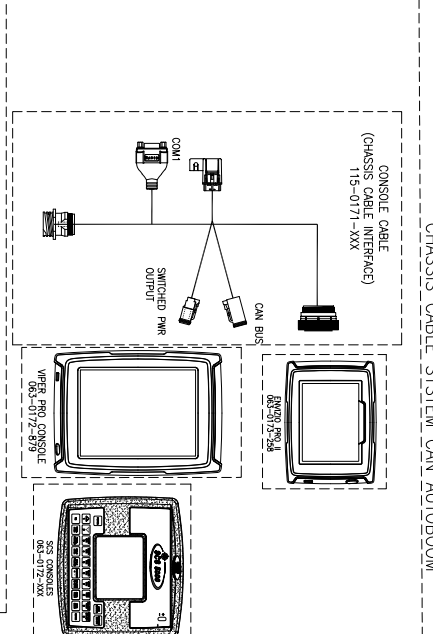
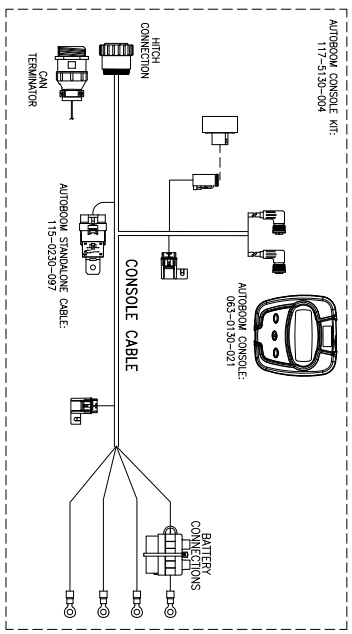
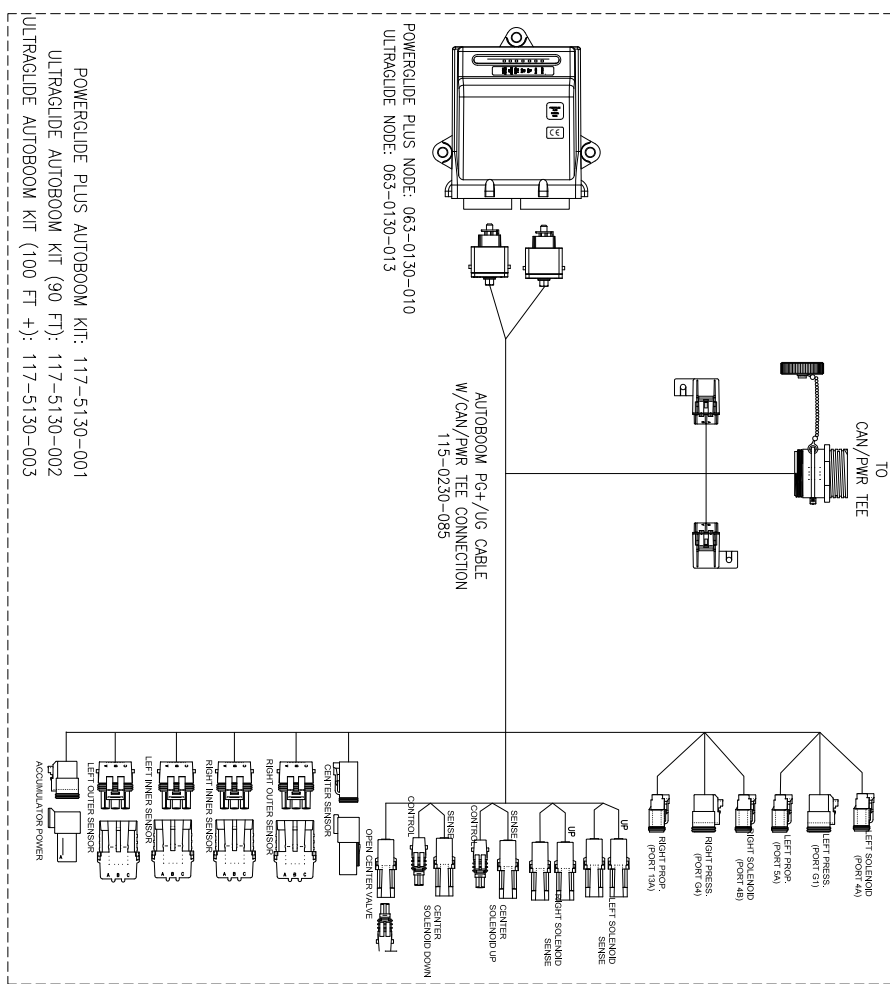
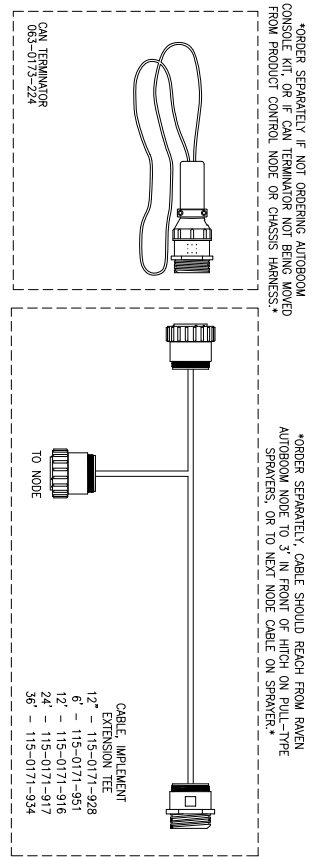





CHAPTER

5

*Replacement Parts*

This section contains replacement part diagrams for the PowerGlide Plus and UltraGlide systems. Refer to these diagrams when calling to request replacement parts.

*Valve Blocks*

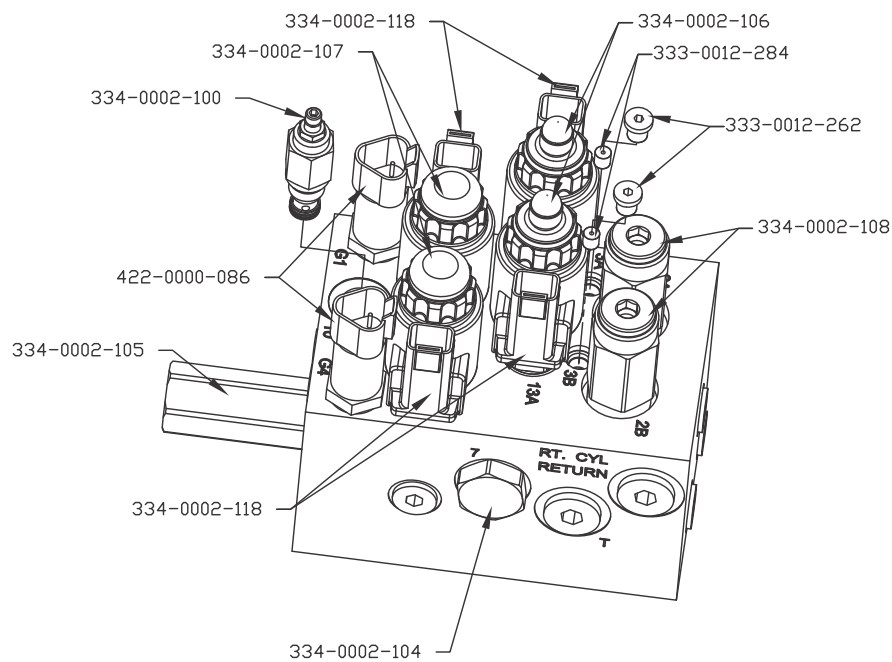

063-0131-126  
VALVE, HYDRAULIC POWERGLIDE  
PLUS/ULTRAGLIDE, OPEN CENTER, AUTOBOOM

# Wheels

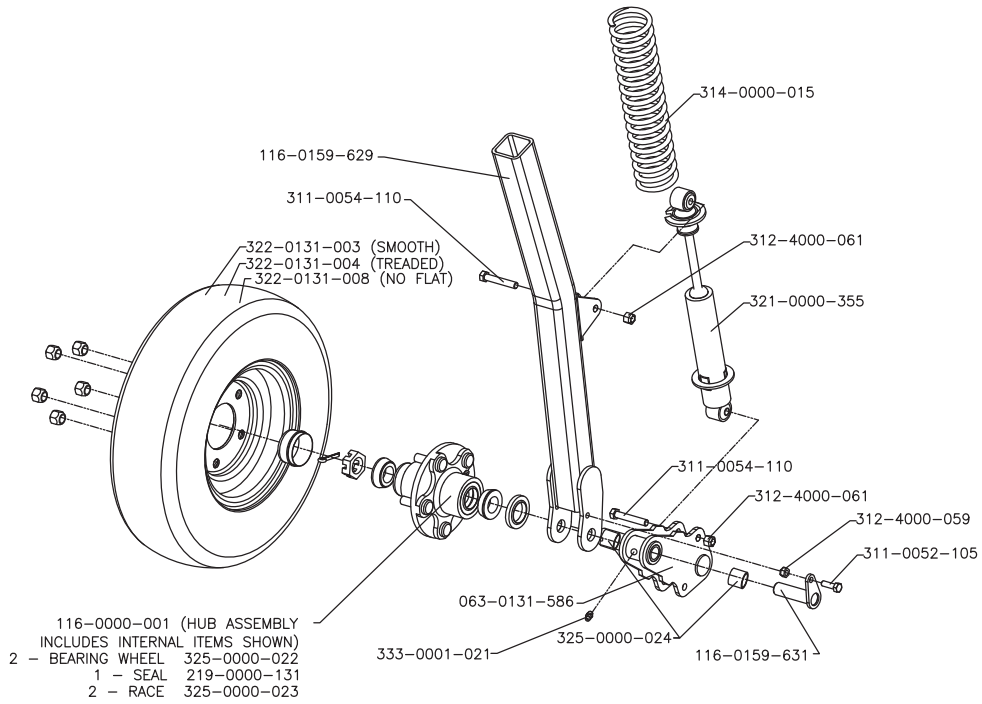

# Sensors

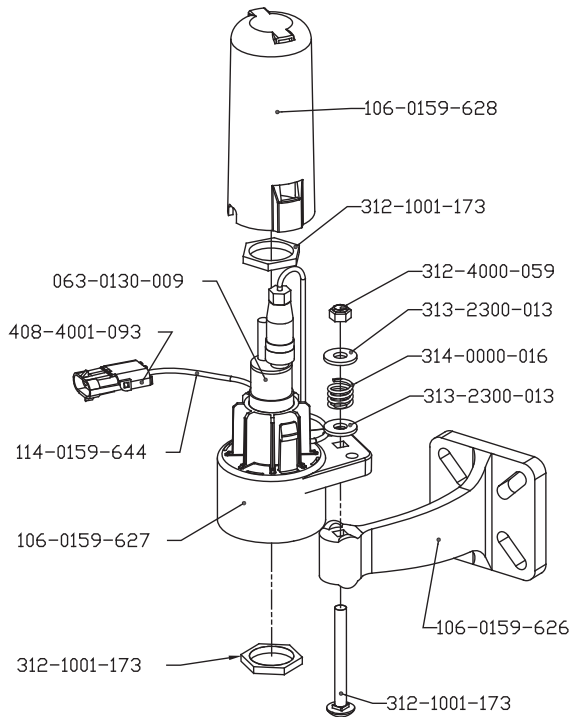

**H****Hydraulic**

- Fittings 4
- Safety 2

**I****Important Safety Information**

- Electrical Safety 2
- Hydraulic Safety 2

**Introduction**

- Hydraulic Fittings 4
- Preparing for Installation 4
  - Point of Reference 4
  - Recommendations 4
  - Tools Needed 4

**K****Kit Contents**

- PowerGlide Plus 7
- UltraGlide 29

**P****Point of Reference 4****PowerGlide Plus 7**

- Install
  - Gauge Wheel Mounting Locations 21
  - Gauge Wheels 21
    - Mounting the Gauge Wheels 21
  - Hydraulic System 12
    - Hydraulic Schematic 20
    - Installing Fittings on the AutoBoom Valve 15
    - Installing Left and Right Cylinder Hoses 18
    - Installing Pressure and Tank Hoses 17
    - Mounting the AutoBoom Valve 16
    - Removing the Left and Right Down Hoses 18
    - Removing the Orifice Fittings 12
  - Wiring 22
    - Connecting the Controller 25
    - Connecting the Field Computer 25
    - Connecting the Harness Cable to the Controller Cable 24
    - Connecting the Harness Cable to the Controller Cable - Gen I Cable Only 25
    - Connecting the Harness Cable to the Implement Extension Tee - Gen II Cable Only 24
    - Connecting the Harness to Boom Function Controls 23
    - Connecting the Power Leads 25
    - Installing the AutoBoom Node 22
    - Wiring Connections 22
    - Wiring Schematics
      - Gen I Cabling 26
      - Gen II Cabling 27
- Kit Contents 7

**R****Recommendations 4****Replacement Parts 53**

- Sensors 54
- Valves 53
- Wheels 54

**T****Tools Needed 4****U****UltraGlide****Install**

- Gauge Wheel Mounting Locations 44
- Gauge Wheels 44
  - Mounting the Gauge Wheels (Optional) 44
- Hydraulic System 35
  - Hydraulic Schematic 41
  - Installing Fittings on the AutoBoom Valve 36
  - Installing Left and Right Cylinder Hoses 39
  - Installing Pressure and Tank Hoses 38
  - Mounting the AutoBoom Valve 37
  - Removing the Left and Right Down Hoses 39
- Sensors 42
  - Boom Sensor Mounting Locations 42
  - Connecting Sensor Cables 43
  - Mounting the Boom Sensors 42
  - Mounting the Center Rack Sensor 43
- Wiring 45
  - Connecting the Controller 49
  - Connecting the Field Computer 49
  - Connecting the Harness Cable to the Controller Cable - Gen I Cable Only 49
  - Connecting the Harness Cable to the Implement Extension Tee - Gen II Cable Only 48
  - Connecting the Harness Cable to the Sensors 48
  - Connecting the Harness to Boom Function Controls 23, 46
  - Connecting the Power Leads 49
  - Installing the AutoBoom Node 45
  - Installing the Center Rack Control 48
  - Wiring Connections 45
  - Wiring Schematics
    - Gen I Cabling 50
    - Gen II Cabling 51
- Kit Contents 29



**RAVEN**

# **RAVEN INDUSTRIES**

## **Limited Warranty**

---

### ***What Does this Warranty Cover?***

This warranty covers all defects in workmanship or materials in your Raven Applied Technology Division product under normal use, maintenance, and service.

### ***How Long is the Coverage Period?***

Raven Applied Technology Division products are covered by this warranty for 12 months after the date of purchase. This warranty coverage applies only to the original owner and is nontransferable.

### ***How Can I Get Service?***

Bring the defective part and proof of purchase to your Raven dealer. If your dealer agrees with the warranty claim, the dealer will send the part and proof of purchase to their distributor or to Raven Industries for final approval.

### ***What Will Raven Industries Do?***

Upon confirmation of the warranty claim, Raven Industries will, at our discretion, repair or replace the defective part and pay for return freight.

### ***What is not Covered by this Warranty?***

Raven Industries will not assume any expense or liability for repairs made outside our facilities without written consent. Raven Industries is not responsible for damage to any associated equipment or products and will not be liable for loss of profit or other special damages. The obligation of this warranty is in lieu of all other warranties, expressed or implied, and no person or organization is authorized to assume any liability for Raven Industries.

Damages caused by normal wear and tear, misuse, abuse, neglect, accident, or improper installation and maintenance are not covered by this warranty.

# RAVEN

Hardi Eagle  
AutoBoom™ Installation Manual  
(P/N 016-0230-026 Rev D 09/11 E18171)



## Raven Industries

Applied Technology Division  
P.O. Box 5107  
Sioux Falls, SD 57117-5107  
[www.ravenprecision.com](http://www.ravenprecision.com)

Toll Free (U.S. and Canada): (800)-243-5435  
or Outside the U.S. :1 605-575-0722  
Fax: 605-331-0426  
[www.ravenhelp.com](http://www.ravenhelp.com)

**Notice:** This document and the information provided are the property of Raven Industries, Inc. and may only be used as authorized by Raven Industries, Inc. All rights reserved under copyright laws.