

**Apache (2004 & Older)
AutoBoom™ Installation Manual**

P/N 016-0230-013 Rev D

09/15

E18131

Disclaimer

While every effort has been made to ensure the accuracy of this document, Raven Industries assumes no responsibility for omissions and errors. Nor is any liability assumed for damages resulting from the use of information contained herein.

Raven Industries shall not be responsible or liable for incidental or consequential damages or a loss of anticipated benefits or profits, work stoppage or loss, or impairment of data arising out of the use, or inability to use, this system or any of its components. Raven Industries shall not be held responsible for any modifications or repairs made outside our facilities, nor damages resulting from inadequate maintenance of this system.

As with all wireless and satellite signals, several factors may affect the availability and accuracy of wireless and satellite navigation and correction services (e.g. GPS, GNSS, SBAS, etc.). Therefore, Raven Industries cannot guarantee the accuracy, integrity, continuity, or availability of these services and cannot guarantee the ability to use Raven systems, or products used as components of systems, which rely upon the reception of these signals or availability of these services. Raven Industries accepts no responsibility for the use of any of these signals or services for other than the stated purpose.

Chapter 1	<i>Important Safety Information</i>	1
	Hydraulic Safety	2
	Electrical Safety	2
Chapter 2	<i>Introduction</i>	3
	Preparing for Installation	4
	Recommendations	4
	Point of Reference	4
	Hydraulic Fittings	4
Chapter 3	<i>PowerGlide</i>	7
	PowerGlide Kit Contents	7
	Install Fittings on the AutoBoom Valve	10
	Mount the AutoBoom Valve	11
	Install the Left and Right Cylinder Hoses	13
	PowerGlide Hydraulic Schematic	14
	Install the Gauge Wheels	15
	Gauge Wheel Mounting Locations	15
	Mount the Gauge Wheels	15
	Install the PowerGlide Wiring	16
	Connect the Harness to the Boom Function Controls	16
	Connect the Harness Cable to the Controller Cable	17
	Connect the Controller	17
	Connect the Power Leads	17
	PowerGlide Wiring Schematics	18
	AutoBoom Controller	18
Chapter 4	<i>PowerGlide Plus</i>	19
	PowerGlide Plus Kit Contents	19
	Install the PowerGlide Plus Hydraulic System	23
	Remove the Orifice Fittings	23
	Install Fittings on the AutoBoom Valve	26
	Mount the AutoBoom Valve	26
	Install the Pressure and Tank Hoses	27
	Install the Left and Right Cylinder Hoses	28
	PowerGlide Plus Hydraulic Schematic	30
	Install the Gauge Wheels	31
	Gauge Wheel Mounting Locations	31
	Mount the Gauge Wheels	31
	Install the PowerGlide Plus Wiring	32
	Install the AutoBoom Node	32
	Connect the Harness to the Boom Function Controls	33

Connect the Harness Cable to the Implement Extension Tee - Gen II Cable Only	33
Connect the Harness Cable to the Controller Cable - Gen I Cable Only	34
Connect the Controller (If Applicable) - Gen I Cable Only	34
Connect the Field Computer (If Applicable)	34
Connect the Power Leads	34
PowerGlide Plus Wiring Schematic	35
Gen I Cabling	35
Gen II Cabling	36

Chapter 5 *UltraGlide* **37**

UltraGlide Kit Contents	37
Install Fittings on the AutoBoom Valve	42
Mount the AutoBoom Valve	42
Install the Left and Right Cylinder Hoses	44
UltraGlide Hydraulic Schematic	45
Install the UltraGlide Sensors	46
Boom Sensor Mounting Locations	46
Mount the Center Rack Sensor	47
Connect the Sensor Cables	47
Install the Gauge Wheels - Optional	48
Gauge Wheel Mounting Locations	48
Mount the Gauge Wheels	48
Install the UltraGlide Wiring	49
Install the AutoBoom Node	49
Connect the Harness to the Boom Function Controls	50
Install the Center Rack Control - Model Year 2002-2004 Only	51
Connect the Harness Cable to the Sensors	51
Connect the Harness Cable to the Implement Extension Tee - Gen II Cable Only	52
Connect the Harness Cable to the Controller Cable - Gen I Cable Only	52
Connect the Controller (If Applicable) - Gen I Cable Only	52
Connect the Field Computer (If Applicable)	52
Connect the Power Leads	52
UltraGlide Wiring Schematic	53
Gen I Cabling	53
Gen II Cabling	54

Chapter 6 *Replacement Parts* **55**

Valve Blocks	55
PowerGlide Plus and UltraGlide Valve Block Replacement Parts	56
Wheels	56
Sensors	57

CHAPTER

1

Important Safety Information

NOTICE

Read this manual and the operation and safety instructions included with your implement and/or controller carefully before installing the AutoBoom™ system.

- Follow all safety information presented within this manual.
- If you require assistance with any portion of the installation or service of your Raven equipment, contact your local Raven dealer for support.
- Follow all safety labels affixed to the AutoBoom system components. Be sure to keep safety labels in good condition and replace any missing or damaged labels. To obtain replacements for missing or damaged safety labels, contact your local Raven dealer.

When operating the machine after installing AutoBoom, observe the following safety measures:

- Be alert and aware of surroundings.
- Do not operate AutoBoom or any agricultural equipment while under the influence of alcohol or an illegal substance.
- Remain in the operator's position in the machine at all times when AutoBoom is engaged.
- Disable AutoBoom when exiting from the operator's seat and machine.
- Do not drive the machine with AutoBoom enabled on any public road.
- Determine and remain a safe working distance from other individuals. The operator is responsible for disabling AutoBoom when the safe working distance has diminished.
- Ensure AutoBoom is disabled prior to starting any maintenance work on AutoBoom or the machine.

WARNING

- When starting the machine for the first time after installing AutoBoom, be sure that all persons stand clear, in case a hose has not been properly tightened.
- The machine must remain stationary and switched off, with the booms unfolded and supported, during installation or maintenance.

 **CAUTION**

Hydraulic Safety

- Raven Industries recommends that appropriate protective equipment must be worn at all times when working on the hydraulic system.
- Never attempt to work on a hydraulic system with the equipment running. Care should always be taken when opening a system that has been previously pressurized.
- When disconnecting the hydraulic hoses or purging is required, be aware that the hydraulic fluid may be extremely hot and under high pressure. Caution must be exercised.
- Any work performed on the hydraulic system must be done in accordance with the machine manufacturer's approved maintenance instructions.
- When installing AutoBoom hydraulics or performing diagnostics, maintenance, or routine service, ensure that precautions are taken to prevent any foreign material or contaminants from introduced into the machine's hydraulic system. Objects or materials that are able to bypass the machine's hydraulic filtration system will reduce performance and possibly damage the AutoBoom hydraulic valve.

Electrical Safety

- Always verify that the power leads are connected to the correct polarity as marked. Reversing the power leads could cause severe damage to the equipment.
- Ensure that the power cable is the last cable to be connected.

CHAPTER

2

Introduction

Congratulations on your purchase of the Raven AutoBoom system! This system is designed to provide automated boom height adjustment for agricultural spraying equipment.

This manual applies to the following machines. For future reference, write the serial number of your machine in the space below.

MAKE: Apache
MODEL: 2004 & Older
YEAR:
SERIAL NUMBER:

FIGURE 1. Apache



Note: *This manual contains the installation instructions for the PowerGlide, PowerGlide Plus, and UltraGlide systems. Be sure to identify which system you have and follow only the instructions for that system.*

Preparing for Installation

Before installing AutoBoom, park the machine where the ground is level, clean, and dry. Leave the machine turned off for the duration of the installation process.

During the installation process, follow good safety practices. Be sure to carefully read the instructions in this manual as you complete the installation process.

Recommendations

Raven Industries recommends the following best practices before installing or operating the AutoBoom system for the first time, at the start of the season, or when moving the AutoBoom system to another machine:

- Ensure the machine's hydraulic filters have been recently changed and there are no issues with the machine's hydraulic system (e.g., pump issues, faulty hydraulic motors, fine metal deposits in the hydraulic hoses, etc.).
- Operate each of the machine's boom hydraulic functions (i.e., tilt, fold, center rack, tongue extension, or other hydraulic valve functions) three times to ensure the machine's hydraulic valve is using fresh oil and debris is flushed from the hydraulic hoses, valves, and filters.
- Upon installation of the AutoBoom system, operate the boom and center rack raise/lower functions through the machine's manual control functions first before operating them via the AutoBoom controller/field computer to ensure the hydraulic system has been installed correctly and air is released from the system.

Raven Industries recommends the following best practices when installing the AutoBoom system.

- Use part numbers to identify the parts.
- Do not remove the plastic wrap from a part until it is necessary for installation.
- Do not remove plastic caps from a part until it is necessary for installation.

Tools Needed

The following tools are recommended for installation of the AutoBoom system:

- SAE standard-sized wrenches
- Cable ties
- Set of tools

Point of Reference

The instructions in this manual assume that you are standing behind the machine, looking toward the cab.

Hydraulic Fittings

This manual may reference the following types of hydraulic fittings:

- SAE O-ring fittings
- ORFS (O-Ring Face Seal) fittings
- JIC fittings

SAE O-ring fitting



ORFS fitting



JIC fitting (M)



CHAPTER

3

PowerGlide

PowerGlide Kit Contents

This section contains a list of the components that are included in the PowerGlide AutoBoom kit. Before beginning the AutoBoom installation, compare the items in the AutoBoom kit with the components on this list. If you have questions about the kit, contact your Raven dealer.

Note: *In addition to the following kit components, an axle kit is required for the operation of the PowerGlide AutoBoom system. For available kits and ordering information, contact your local Raven dealer.*

TABLE 1. PowerGlide Installation Kit (P/N 117-0230-013)



Picture	Item Description	Part Number	Qty.
Not Pictured	Manual - Apache (2004 & Older) AutoBoom Installation	016-0230-013	1
	Valve - UltraGlide AutoBoom	063-0131-127	1
	Plate - Hydraulic Block Mounting	107-0171-619	1
	Bracket - Weldment Receiver	116-0159-592	2
	Wheel	322-0131-008	2

TABLE 1. PowerGlide Installation Kit (P/N 117-0230-013)

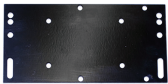

Picture	Item Description	Part Number	Qty.
	Cable - Boom Sense Adapter	115-0171-558	4
	Fitting - 3/4" Hex Plug	333-0012-211	1
	U-Bolt - 3-1/16" W x 5" L x 3/8" Thread	107-0171-607	2
	U-Bolt - 1-9/16" W x 2-1/2" L x 3/8" Thread	107-0171-611	8
	Bolt - 5/16"-18 x 7/8" Hex	311-0052-104	4
	Bolt - 1/2"-13 x 1-1/2" SS hex	311-0058-186	4
	Nut - 1/2"-13 Zinc Hex	312-1001-043	4
	Nut - 3/8"-16 Zinc Flanged Lock	312-1001-164	20
	Washer - 5/16" Zinc Plated Lock	313-1000-019	4

TABLE 2. Hydraulic Kit (P/N 117-0134-013)

Picture	Item Description	Part Number	Qty.
	Fitting - 9/16" JIC M/F 90° Swivel Elbow	333-0012-042	2
	Fitting - 9/16" JIC M/M/F Swivel Run Tee	333-0012-043	4
	Fitting - 9/16" JIC (M) to 9/16" SAE O-Ring (M) Straight Adapter	333-0012-045	2
	Fitting - 9/16" JIC (M) to 3/4" SAE O-Ring (M) Straight Adapter	333-0012-046	2
	Fitting - 11/16" Hex 9/16" Plug	333-0012-194	2
	Hydraulic Hose - 9/16" JIC (F) 90° to 9/16" JIC (F) - 48"	214-1000-139	2
	Hydraulic Hose - 9/16" JIC (F) 90° to 9/16" JIC (F) - 72"	214-1000-292	2

TABLE 3. PowerGlide Wiring Kit (P/N 117-0137-022)



Picture	Item Description	Part Number	Qty.
Not Pictured	Manual - AutoBoom PowerGlide Calibration Operator's	016-0130-061	1
	Controller - PowerGlide AutoBoom	063-0130-011	1

TABLE 3. PowerGlide Wiring Kit (P/N 117-0137-022)

Picture	Item Description	Part Number	Qty.
	Cable - AutoBoom Controller	115-0230-002	1
	Cable - AutoBoom Valve Harness	115-0230-003	1

Install Fittings on the AutoBoom Valve

Before mounting the AutoBoom valve on the machine, install the proper fittings on the valve. This prepares the valve for installation and simplifies the hose connection process later in the procedure. Refer to the following table to install the fittings in the appropriate ports on the AutoBoom valve.

Fitting	Part Number	Port
Fitting - 9/16" JIC (M) to 9/16" SAE O-Ring (M) Straight Adapter	333-0012-045	LC, RC
Fitting - 9/16" JIC M/F 90° Swivel Elbow	333-0012-042	LC, RC
Fitting - 9/16" JIC (M) to 3/4" SAE O-Ring (M) Straight Adapter	333-0012-046	P, T
Fitting - 11/16" Hex 9/16" Plug	333-0012-194	LV, RV
Fitting - 3/4" Hex Plug	333-0012-211	EF

Mount the AutoBoom Valve

FIGURE 1. AutoBoom Valve Mounted on the Valve Mounting Plate

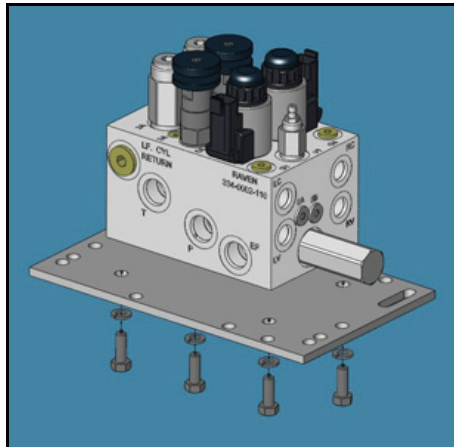

1. Secure the PowerGlide AutoBoom valve (P/N 063-0131-127) to the valve mounting plate (P/N 107-0171-619) using four 5/16" hex bolts (P/N 311-0052-104) and four 5/16" lock washers (P/N 313-1000-019).

FIGURE 2. AutoBoom Valve Mounted on the Sprayer

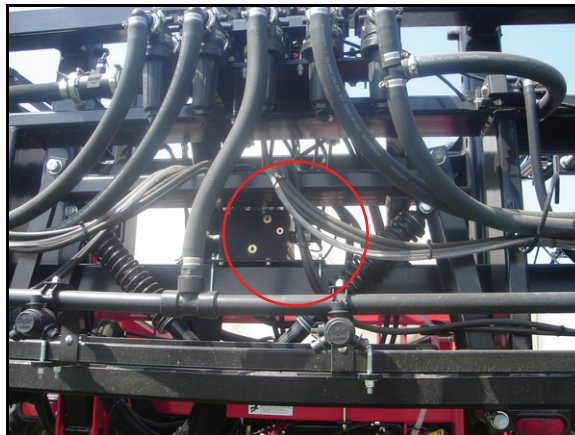

2. Secure the mounting plate on the center rack using two 3-1/16" W x 5" L x 3/8" thread U-bolts (P/N 107-0171-607) and four 3/8"-16 zinc flanged lock nuts (P/N 312-1001-164).

Install the Pressure and Tank Hoses

	<p>⚠ WARNING</p> <p>Hydraulics are under pressure. Care should always be taken with a system that has been pressurized. When disconnecting or purging hydraulic hoses, be aware that the hydraulic fluid within the machine's system may be extremely hot and under high pressure.</p>
---	---

	<p>⚠ CAUTION</p> <p>When installing AutoBoom hydraulics or performing diagnostics, maintenance, or routine service, ensure precautions are taken to prevent any foreign material or contaminants from being introduced into the machine's hydraulic system.</p> <p>Objects or materials that are able to bypass the machine's hydraulic filtration system will reduce performance and possibly damage the AutoBoom hydraulic valve.</p>
---	--

FIGURE 3. Pressure and Tank Hoses Installed



1. Disconnect the machine's pressure line from the machine's hydraulic valve (port P).
2. Install a 9/16" JIC M/M/F swivel run tee fitting (P/N 333-0012-043) in the port P of the machine's hydraulic valve.
3. Connect the machine's pressure hose to the opposite end of the installed tee fitting.
4. Install the straight end of the supplied hydraulic hose (P/N 214-1000-139) on the 90° end of the tee fitting.
5. Connect the 90° end of the installed hydraulic hose to the installed fitting in Port P of the AutoBoom valve.
6. Disconnect the machine's tank hose from the machine's hydraulic valve (port T).
7. Install a 9/16" JIC M/M/F swivel run tee fitting (P/N 333-0012-043) in port T of the machine's hydraulic valve.
8. Connect the machine's pressure hose to the opposite end of the installed tee fitting.
9. Install the straight end of the supplied hydraulic hose (P/N 214-1000-139) on the 90° end of the tee fitting.
10. Connect the 90° end of the installed hydraulic hose to the installed fitting in Port T of the AutoBoom valve.

Install the Left and Right Cylinder Hoses

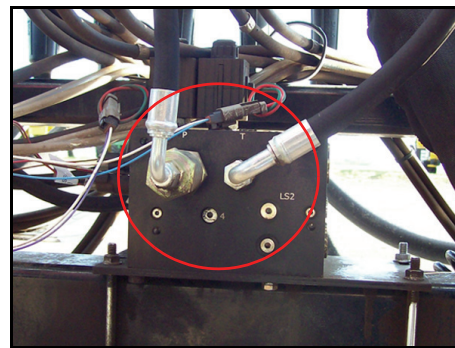
FIGURE 4. Cylinder Hoses Installed on Machine's Hydraulic Valve

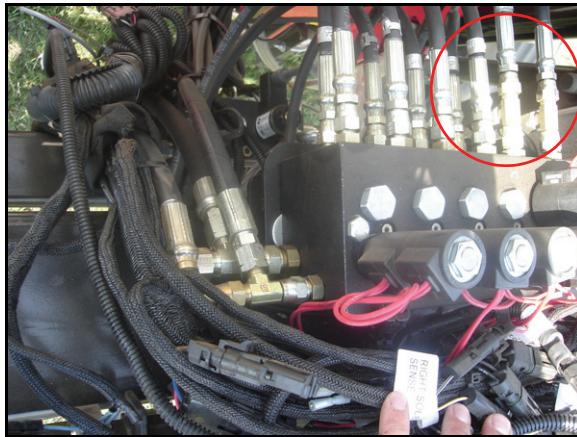

1. Disconnect the left and right up hoses from the machine's hydraulic valve.
2. Install a 9/16" JIC M/M/F swivel run tee fitting (P/N 333-0012-043) in the left up port of the machine's hydraulic valve.
3. Connect the machine's left up hose to the opposite end of the installed tee fitting.
4. Install the 90° end of the supplied hydraulic hose (P/N 214-1000-292) on the 90° end of the installed tee fitting.
5. Connect the straight end of the installed hydraulic hose to the installed fittings in Port LC on the AutoBoom valve.
6. Install a 9/16" JIC M/M/F swivel run tee fitting (P/N 333-0012-043) in the right up port of the machine's hydraulic valve.
7. Connect the machine's right up hose to the opposite end of the installed tee fitting.
8. Install the 90° end of the supplied hydraulic hose (P/N 214-1000-292) on the 90° end of the installed tee fitting.
9. Connect the straight end of the installed hydraulic hose to the installed fittings in Port RC of the AutoBoom valve.

PowerGlide Hydraulic Schematic

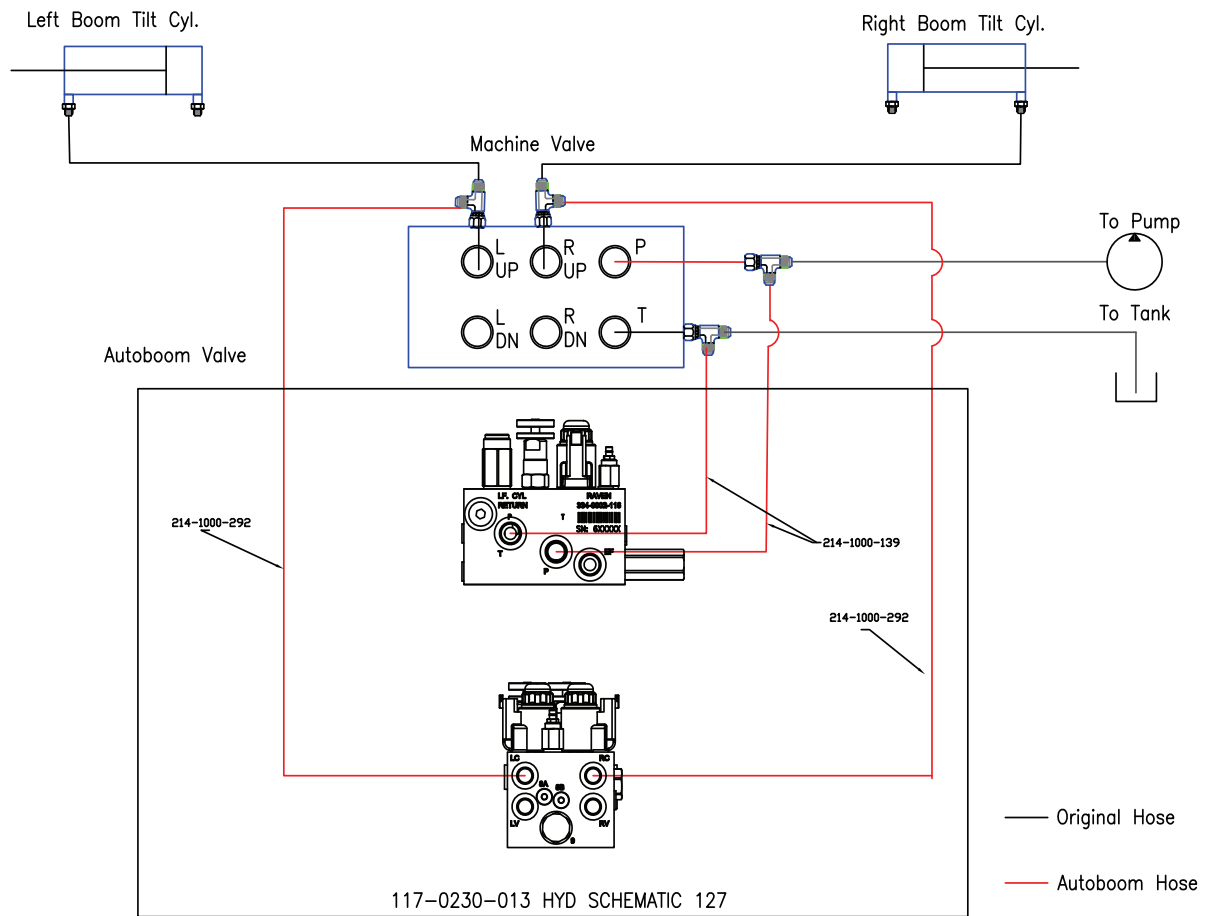



Install the Gauge Wheels

Gauge Wheel Mounting Locations

Wheel mounting locations may be influenced by the boom configuration. Determine the appropriate location for mounting the wheels on the boom, ensuring the wheels will not interfere with or be damaged while folding or unfolding the booms. The wheels should be mounted outside of the boom fold, but inside the boom breakaway.

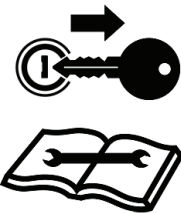
Mount the Gauge Wheels

	<div style="background-color: #e67e22; color: white; padding: 5px; text-align: center;">  WARNING </div> <p>The machine must remain stationary and switched off, with the booms unfolded and supported, during installation or maintenance.</p>
---	---

Note: The appearance of the wheel axles may vary, depending on the wheel axle kit that was ordered.

FIGURE 5. Gauge Wheel Installed (Booms Folded)



1. Remove the nuts from the right wheel axle).
2. Place the wheel (P/N 322-0131-008) on the right wheel axle.
3. Reinstall the lug nuts on the wheel axle to secure the wheel.
4. Mount the right receiver bracket (P/N 116-0159-592) to the front of the right boom using four 1-9/16" W x 2-1/2" L x 3/8" thread U-bolts (P/N 107-0171-611) and eight 3/8"-16 zinc flanged lock nuts (P/N 312-1001-164).
5. Insert the right wheel axle into the mounting bracket, positioning it so that the bottom of the wheel touches the ground (or nearly so) and the wheel faces away from the machine.
6. Secure the gauge wheel assembly in the wheel mounting bracket by installing two 1/2"-13 x 1-1/2" SS hex bolts (P/N 311-0058-186) and two 1/2" zinc hex nuts (P/N 312-1001-043).
7. Repeat the steps above to install the left wheel.

Install the PowerGlide Wiring

Wiring Connections

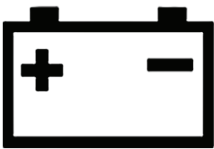
	<p style="text-align: center;">⚠ CAUTION</p> <p>Always connect the power cable as the last step in the wiring process and verify that the power leads are connected with the correct polarity. Reversing power leads can cause severe damage to the equipment.</p>
---	---

For wiring connections made outside the cab, apply dielectric silicone grease (P/N 222-0000-006) generously on both the male and female ends of the connectors. Application of the grease will prevent corrosion to the pins and wires.

Connect the Harness to the Boom Function Controls

1. Locate the Left Solenoid and Right Solenoid connectors on the harness cable (P/N 115-0230-003).
2. Connect the Left Solenoid connector to Port 4A on the AutoBoom valve.
3. Connect the Right Solenoid connector to Port 4B on the AutoBoom valve.

FIGURE 6. Machine's Left and Right Tilt Boom Function Coils

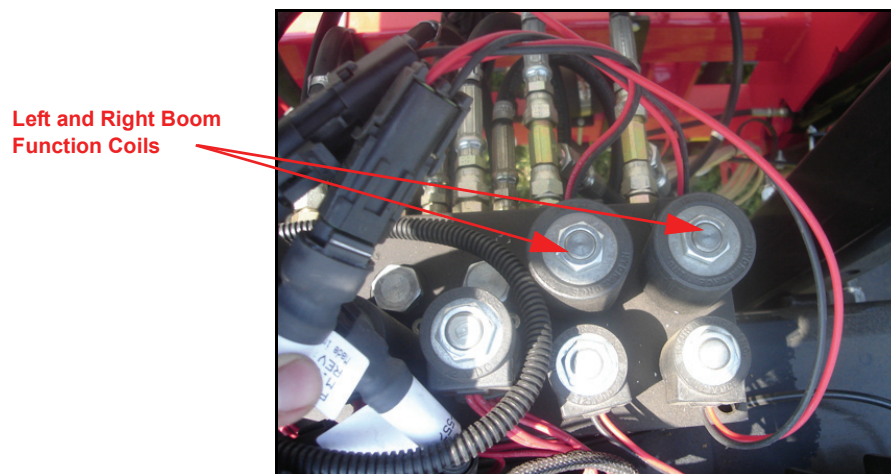

4. Locate the machine's boom function coils on the machine's hydraulic valve.
5. Disconnect the connector from the machine's left tilt up coil.
6. Install a boom sense adapter cable (P/N 115-0171-558) between the coil and the machine's coil connector.
7. Connect boom sense adapter cables between the left tilt down, right tilt up, and right tilt down coils and to the coil connectors.
8. On the harness cable, locate the Left Solenoid Sense connectors. Isolate the connector labeled Up and connect it to the left tilt up coil via the installed boom sense adapter cable.
9. Connect the down Left Solenoid Sense connector to the left tilt down coil via the installed boom sense adapter cable.
10. Connect the Right Solenoid Sense connectors to the machine's right tilt up and right tilt down coils via the installed boom sense adapter cables.

Connect the Harness Cable to the Controller Cable

1. Route the harness cable (P/N 115-0230-003) toward the machine's cab.
2. Connect the harness cable to the controller cable (P/N 115-0230-002). Tighten the connector screw cap to secure.

Note: Be sure to allow enough slack in the harness cable to allow for boom racking.

Connect the Controller

FIGURE 7. Controller Connectors



1. Route the controller cable (P/N 115-0230-002) into the right side of the machine's cab.
2. Locate the two controller connectors. Connect these connectors to the AutoBoom controller (P/N 063-0130-011).

Note: The AutoBoom controller should be mounted in the machine's cab so that the machine operator has easy access to it.

Connect the Power Leads

1. Locate the power cable that has the red and white power leads at one end.
2. Disconnect the machine's connectors from the battery terminals.
3. Install the red power lead on the positive battery terminal and reinstall the machine's battery connector.
4. Install the white power lead on the negative battery terminal and reinstall the machine's battery connector.

PowerGlide Wiring Schematics

AutoBoom Controller

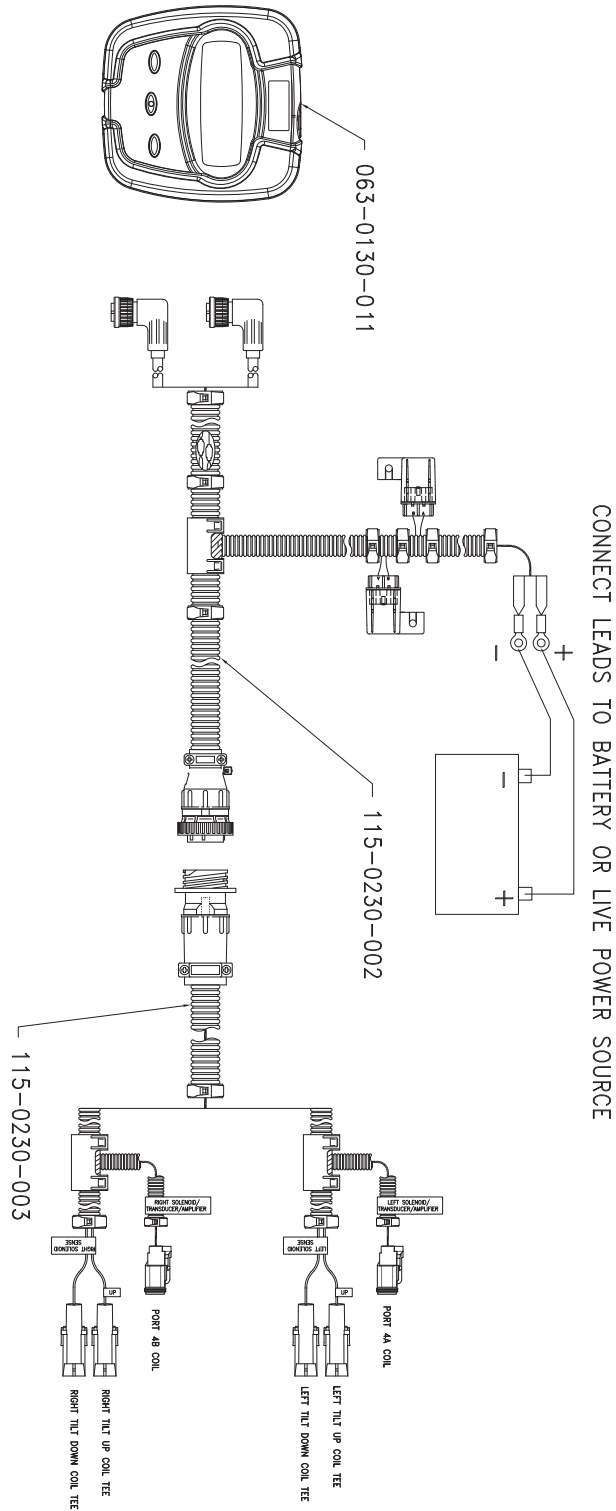

CHAPTER**4*****PowerGlide Plus******PowerGlide Plus Kit Contents***

This section contains a list of the components that are included in the PowerGlide Plus AutoBoom kit. Before beginning the AutoBoom installation, compare the items in the AutoBoom kit with the components on this list. If you have questions about the kit, contact your local Raven dealer.

TABLE 1. PowerGlide Plus Installation Kit (P/N 117-0231-013)





Picture	Item Description	Part Number	Qty.
Not Pictured	Manual - Apache (2004 & Older) AutoBoom Installation	016-0230-013	1
	Valve - PowerGlide Plus AutoBoom	063-0131-124	1
	Plate - Hydraulic Block Mounting	107-0171-619	1
	Cable - Boom Sense Adapter	115-0171-558	4
	U-Bolt - 3-1/16" W x 5" L x 3/8" Thread	107-0171-607	2
	Bolt - 5/16"-18 x 7/8" Hex	311-0052-104	4

TABLE 1. PowerGlide Plus Installation Kit (P/N 117-0231-013)



Picture	Item Description	Part Number	Qty.
	Nut - 3/8"-16 Zinc Flanged Lock	312-1001-164	4
	Washer - 5/16"-24 x 1" Grade 8 Lock	313-1000-019	4

TABLE 2. Hydraulic Kit (P/N 117-0134-013)

Picture	Item Description	Part Number	Qty.
	Fitting - 9/16" JIC M/F 90° Swivel Elbow	333-0012-042	2
	Fitting - 9/16" JIC M/M/F Swivel Run Tee	333-0012-043	4
	Fitting - 9/16" JIC (M) to 9/16" SAE O-Ring (M) Straight Adapter	333-0012-045	2
	Fitting - 9/16" JIC (M) to 3/4" SAE O-Ring (M) Straight Adapter	333-0012-046	2
	Fitting - 11/16" Hex 9/16" Plug	333-0012-194	2
	Hydraulic Hose - 9/16" JIC (F) 90° to 9/16" JIC (F) - 48"	214-1000-139	2
	Hydraulic Hose - 9/16" JIC (F) 90° to 9/16" JIC (F) - 72"	214-1000-292	2

TABLE 3. PowerGlide Plus Wheel Kit (P/N 117-0133-013)

Picture	Item Description	Part Number	Qty.
	Axle Assembly - Right Cushioned AutoBoom	063-0131-585	1
	Axle Assembly - Left Cushioned AutoBoom	063-0131-590	1
	Bracket - Left Weldment Receiver	116-0159-592	2
	Bracket - Hub Retainer	107-0171-617	2
	Wheel	322-0131-008	2
	U-Bolt - 1-9/16" W x 2-1/2" L x 3/8" Thread	107-0171-611	8
	Bolt - 1/2"-13 x 1-1/2" SS Hex	311-0058-186	4
	Nut - 1/2"-13 Zinc Hex	312-1001-043	4
	Nut - 3/8"-16 Zinc Flanged Lock	312-1001-164	16

TABLE 4. Gen I PowerGlide Plus Wiring Kit (P/N 117-0137-023)







Picture	Item Description	Part Number	Qty.
Not Pictured	Manual - AutoBoom Calibration & Operation	016-0130-062	1
	Node - PowerGlide Plus AutoBoom	063-0130-010	1
	Cable - Harness	115-0230-045	1
	Cable - Power/CAN	115-0230-007	1

TABLE 5. Gen II PowerGlide Plus Wiring Kit (P/N 117-5130-001)

Picture	Item Description	Part Number	Qty.
Not Pictured	Manual - AutoBoom Calibration & Operation	016-0130-062	1
	Node - PowerGlide Plus AutoBoom	063-0130-010	1
	Cable - PowerGlide Plus/UltraGlide with CAN/Power Tee AutoBoom	115-0230-085	1

Important: In addition to the Gen II wiring kit components listed above, an implement extension tee cable is required for the operation of the PowerGlide Plus AutoBoom system. For available cables and ordering information, contact your local Raven dealer.

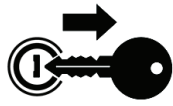
Install the PowerGlide Plus Hydraulic System

 	<p>WARNING</p> <p>The machine must remain stationary and switched off, with the booms unfolded and supported, during installation or maintenance.</p>
--	--

	<p>CAUTION</p> <p>When installing AutoBoom hydraulics or performing diagnostics, maintenance, or routine service, ensure precautions are taken to prevent any foreign material from being introduced into the machine's hydraulic system.</p> <p>Objects or materials that are able to bypass the machine's hydraulic filtration system will reduce performance and possibly cause damage to the AutoBoom hydraulic valve.</p>
---	---

	<p>NOTICE</p> <p>The appearance of the AutoBoom hydraulic valve may vary slightly from the images contained in this manual. However, the fittings, hose connections, and cable connections remain the same.</p>
---	--

Remove the Orifice Fittings

Before populating the hydraulic fittings on the AutoBoom valve, it is necessary to remove orifice fittings from the valve in the PowerGlide Plus system. Failure to remove these fittings from the valve will restrict the down speed of the booms when the system is enabled.

FIGURE 1. Port 3A and 3B Location



1. Locate Ports 3A and 3B on the AutoBoom valve (P/N 063-0131-124).

FIGURE 2. Coil Removed from the AutoBoom Valve



2. Remove the coils from the solenoids near Ports 3A and 3B to gain easy access to those ports.

FIGURE 3. Port Plugs Removed from the AutoBoom Valve

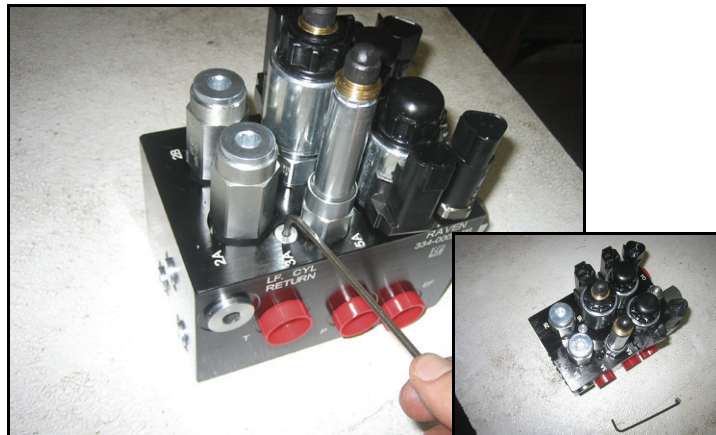

3. Use an Allen wrench to remove the plugs from Ports 3A and 3B.

FIGURE 4. Orifice Fitting Removed from the AutoBoom Valve

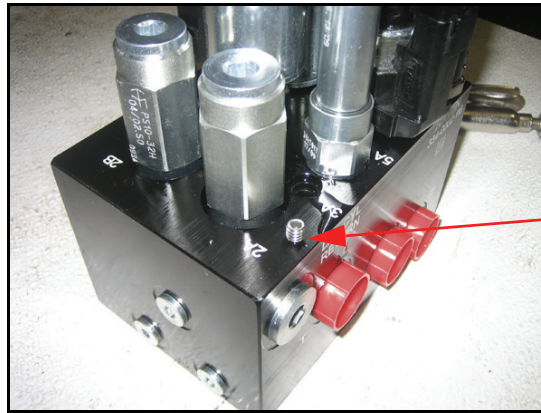

Orifice Fitting
Removed - Keep for
Future Use

- Remove the orifice fittings from Ports 3A and 3B.

Important: Tip the AutoBoom valve on its side and use the Allen wrench to remove the orifice from the cavity, taking care not to let the fitting fall into the valve.

FIGURE 5. Port Plug Reinstalled on the AutoBoom Valve



- Use the Allen wrench to reinstall the port plugs on Ports 3A and 3B of the AutoBoom valve.

FIGURE 6. Coil Reinstalled on the AutoBoom Valve



- Reinstall the coils on the solenoids of the AutoBoom valve.

Install Fittings on the AutoBoom Valve

Before mounting the AutoBoom valve on the machine, install the proper fittings on the valve. This prepares the valve for installation and simplifies the hose connection process later in the procedure. Refer to the following table to install the fittings in the appropriate ports on the AutoBoom valve.

Fitting	Part Number	Port
Fitting - 9/16" JIC (M) to 9/16" SAE O-Ring (M) Straight Adapter	333-0012-045	LC, RC
Fitting - 9/16" JIC M/F 90° Swivel Elbow	333-0012-042	LC, RC
Fitting - 9/16" JIC (M) to 3/4" SAE O-Ring (M) Straight Adapter	333-0012-046	P, T
Fitting - 11/16" Hex 9/16" Plug	333-0012-194	LV, RV

Mount the AutoBoom Valve

FIGURE 7. AutoBoom Valve Mounted on the Valve Mounting Plate

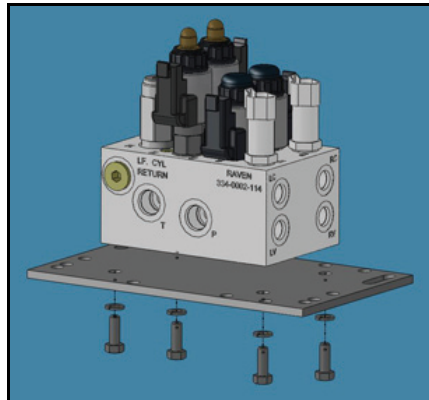

1. Secure the PowerGlide AutoBoom valve (P/N 063-0131-124) to the valve mounting plate (P/N 107-0171-619) using four 5/16" hex bolts (P/N 311-0052-104) and four 5/16" lock washers (P/N 313-1000-019).

FIGURE 8. AutoBoom Valve Mounted on the Sprayer

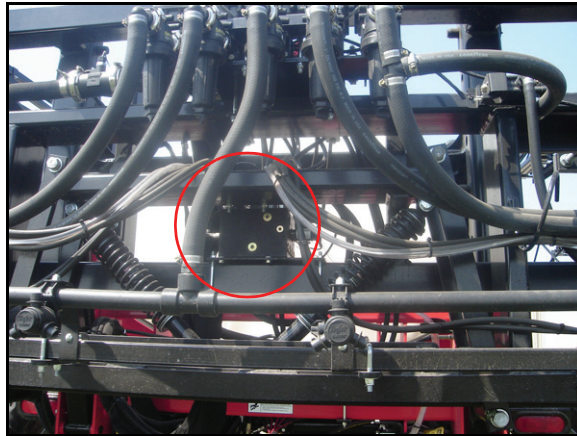

2. Secure the mounting plate on the center rack using two 3-1/16" W x 5" L x 3/8" thread U-bolts (P/N 107-0171-607) and four 3/8"-16 zinc flanged lock nuts (P/N 312-1001-164).

Install the Pressure and Tank Hoses

	<p>⚠ WARNING</p> <p>Hydraulics are under pressure. Care should always be taken with a system that has been pressurized. When disconnecting or purging hydraulic hoses, be aware that the hydraulic fluid within the machine's system may be extremely hot and under high pressure.</p>
--	---

	<p>⚠ CAUTION</p> <p>When installing AutoBoom hydraulics or performing diagnostics, maintenance, or routine service, ensure precautions are taken to prevent any foreign material or contaminants from being introduced into the machine's hydraulic system.</p> <p>Objects or materials that are able to bypass the machine's hydraulic filtration system will reduce performance and possibly damage the AutoBoom hydraulic valve.</p>
---	--

FIGURE 9. Pressure and Tank Hoses Installed



1. Disconnect the machine's pressure line from the machine's hydraulic valve (port P).
2. Install a 9/16" JIC M/M/F swivel run tee fitting (P/N 333-0012-043) in the port P of the machine's hydraulic valve.
3. Connect the machine's pressure hose to the opposite end of the installed tee fitting.
4. Install the straight end of the supplied hydraulic hose (P/N 214-1000-139) on the 90° end of the tee fitting.
5. Connect the 90° end of the installed hydraulic hose to the installed fitting in Port P of the AutoBoom valve.
6. Disconnect the machine's tank hose from the machine's hydraulic valve (port T).
7. Install a 9/16" JIC M/M/F swivel run tee fitting (P/N 333-0012-043) in port T of the machine's hydraulic valve.
8. Connect the machine's pressure hose to the opposite end of the installed tee fitting.
9. Install the straight end of the supplied hydraulic hose (P/N 214-1000-139) on the 90° end of the tee fitting.
10. Connect the 90° end of the installed hydraulic hose to the installed fitting in Port T of the AutoBoom valve.

Install the Left and Right Cylinder Hoses

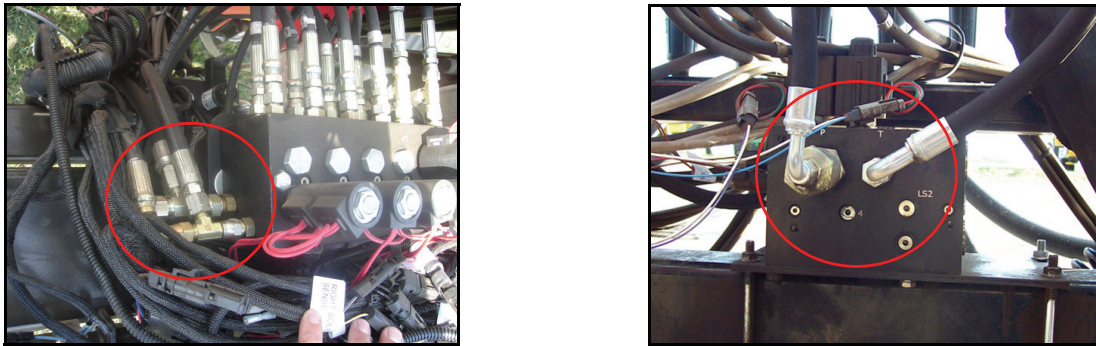
FIGURE 10. Cylinder Hoses Installed on Machine's Hydraulic Valve

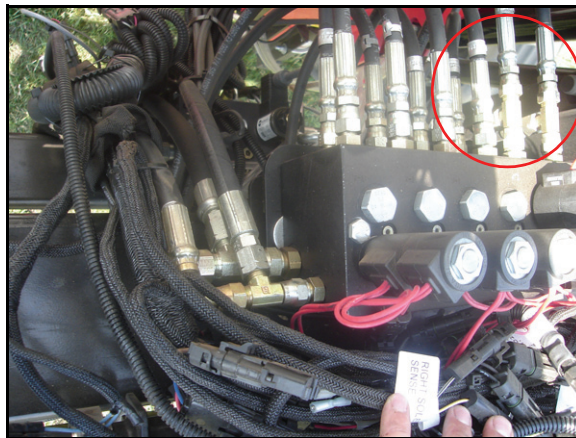

1. Disconnect the left and right up hoses from the machine's hydraulic valve.
2. Install a 9/16" JIC M/M/F swivel run tee fitting (P/N 333-0012-043) in the left up port of the machine's hydraulic valve.
3. Connect the machine's left up hose to the opposite end of the installed tee fitting.
4. Install the 90° end of the supplied hydraulic hose (P/N 214-1000-292) on the 90° end of the installed tee fitting.

5. Connect the straight end of the installed hydraulic hose to the installed fittings in Port LC on the AutoBoom valve.
6. Install a 9/16" JIC M/M/F swivel run tee fitting (P/N 333-0012-043) in the right up port of the machine's hydraulic valve.
7. Connect the machine's right up hose to the opposite end of the installed tee fitting.
8. Install the 90° end of the supplied hydraulic hose (P/N 214-1000-292) on the 90° end of the installed tee fitting.
9. Connect the straight end of the installed hydraulic hose to the installed fittings in Port RC of the AutoBoom valve.



PowerGlide Plus Hydraulic Schematic

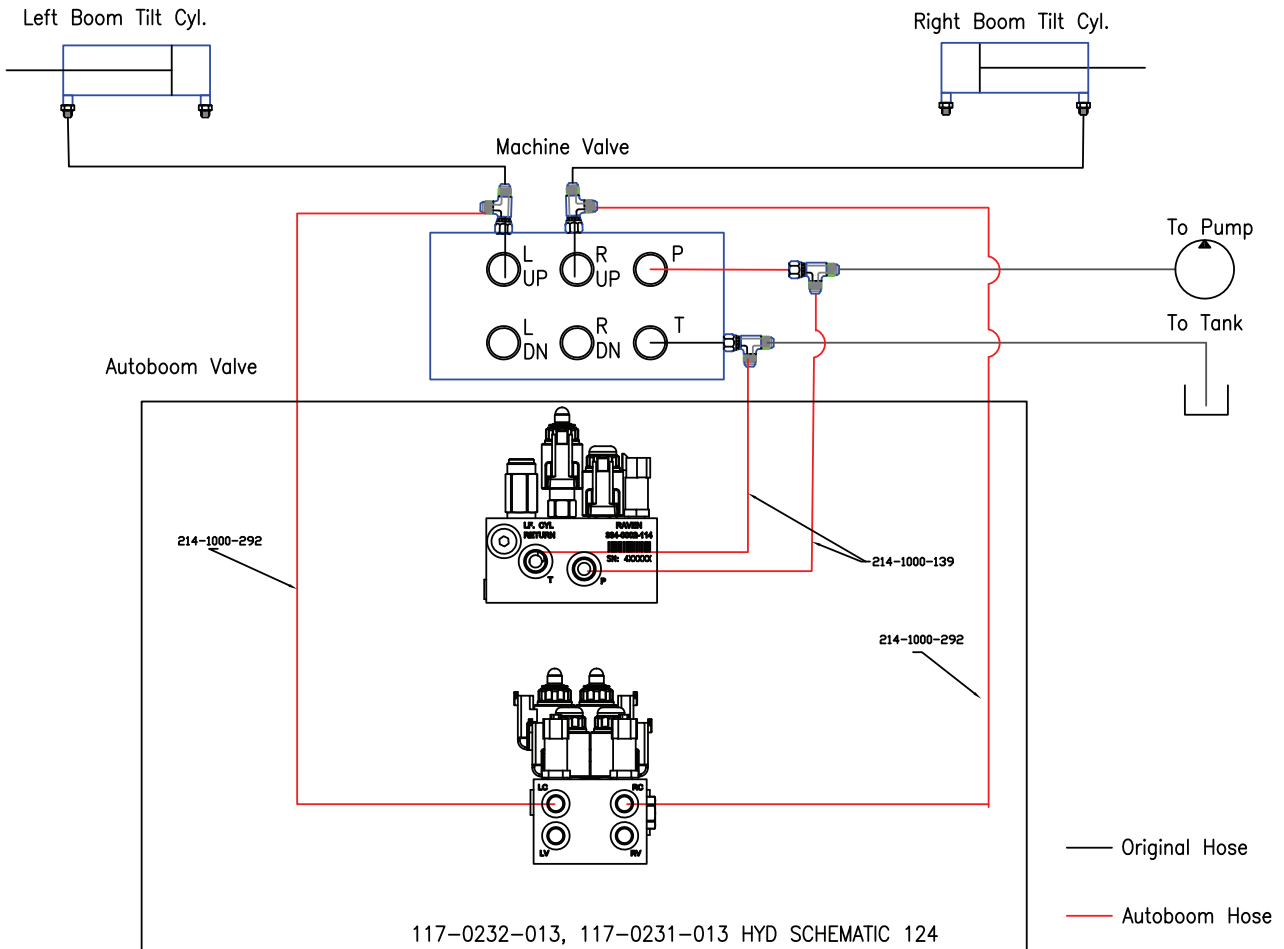



Install the Gauge Wheels

Gauge Wheel Mounting Locations

Wheel mounting locations may be influenced by the boom configuration. Determine the appropriate location for mounting the wheels on the boom, ensuring the wheels will not interfere with or be damaged while folding or unfolding the booms. The wheels should be mounted outside of the boom fold, but inside the boom breakaway.

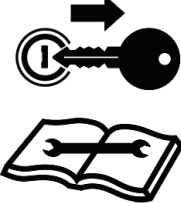
Mount the Gauge Wheels

	<div style="background-color: #e67e22; color: white; padding: 5px; text-align: center;">  WARNING </div> <p>The machine must remain stationary and switched off, with the booms unfolded and supported, during installation or maintenance.</p>
---	---

Note: The appearance of the wheel axles may vary, depending on the wheel kit that was ordered.

FIGURE 11. Gauge Wheel Installed (Booms Folded)



1. Remove the nuts from the right wheel axle (P/N 063-0131-585).
2. Place the wheel (P/N 322-0131-008) on the right wheel axle.
3. Align and place the hub retainer bracket (P/N 107-0171-617) over the wheel.
4. Reinstall the lug nuts on the wheel axle to secure the wheel and hub retainer bracket.
5. Mount the right receiver bracket (P/N 116-0159-592) to the front of the right boom using four 1-9/16" W x 2-1/2" L x 3/8" thread U-bolts (P/N 107-0171-611) and eight 3/8"-16 zinc flanged lock nuts (P/N 312-1001-164).
6. Insert the right wheel axle into the mounting bracket, positioning it so that the bottom of the wheel touches the ground (or nearly so) and the wheel faces away from the machine.
7. Secure the gauge wheel assembly in the wheel mounting bracket by installing two 1/2"-13 x 1-1/2" SS hex bolts (P/N 311-0058-186) and two 1/2" zinc hex nuts (P/N 312-1001-043).
8. Repeat the steps above to install the left wheel.

Install the PowerGlide Plus Wiring

Wiring Connections

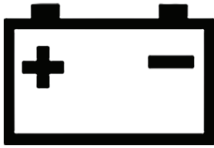
	<p data-bbox="771 338 1068 394">⚠ CAUTION</p> <p data-bbox="636 405 1156 562">Always connect the power cable as the last step in the wiring process and verify that the power leads are connected with the correct polarity. Reversing power leads can cause severe damage to the equipment.</p>
---	---

For wiring connections made outside the cab, apply dielectric silicone grease (P/N 222-0000-006) generously on both the male and female ends of the connectors. Application of the grease will prevent corrosion to the pins and wires.

Install the AutoBoom Node

FIGURE 12. PowerGlide Plus AutoBoom Node Installed

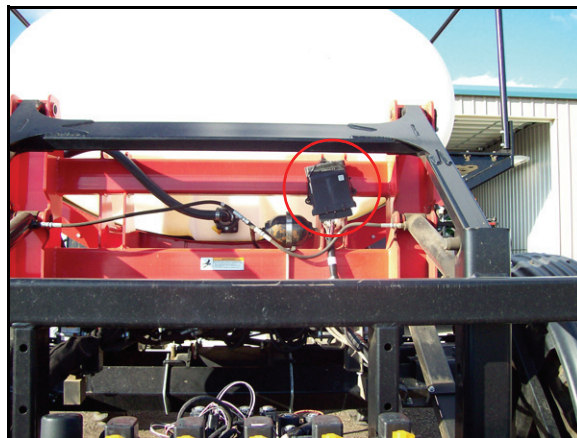

1. Mount the AutoBoom node (P/N 063-0130-010) to the machine's cross beam within close proximity to the AutoBoom valve.
2. Insert the large, rectangular node connectors on the AutoBoom harness cable (P/N 115-0230-045) into the correct ports of the AutoBoom valve.
3. Tighten the bolts on the node connectors to secure the connections.

Connect the Harness to the Boom Function Controls

1. Locate the Left Press and Right Press connectors on the harness cable (P/N 115-0230-045 or 115-0230-085).
2. Route the connectors to the AutoBoom valve (P/N 063-0131-124).
3. Connect the Left Press connector to Port G1 on the AutoBoom valve.
4. Connect the Right Press connector to Port G4 on the AutoBoom valve.
5. Locate the Left Solenoid and Right Solenoid connectors on the harness cable.
6. Connect the Left Solenoid connector to Port 4A on the AutoBoom valve.
7. Connect the Right Solenoid connector to Port 4B on the AutoBoom valve.
8. Locate the Left Prop and Right Prop connectors on the harness cable.
9. Connect the Left Prop connector to Port 5A on the AutoBoom valve.
10. Connect the Right Prop connector to Port 13A on the AutoBoom valve.

FIGURE 13. Machine's Left and Right Tilt Boom Function Coils

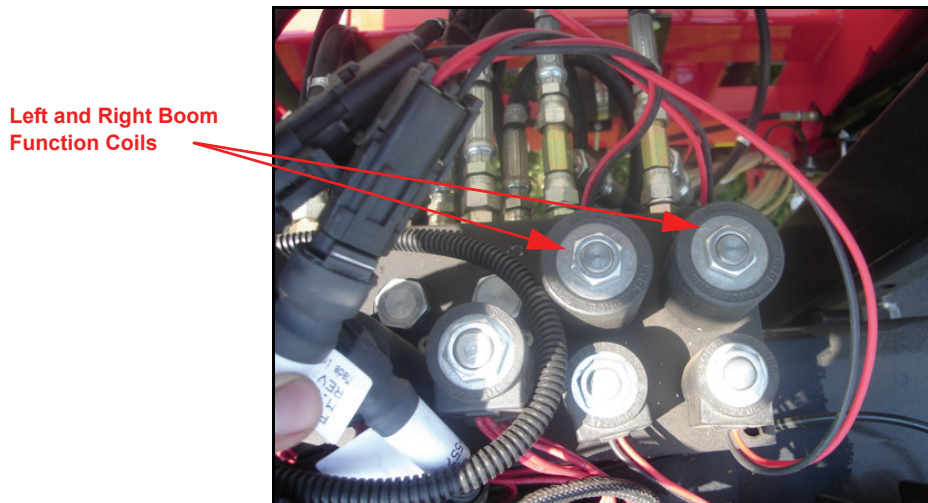

11. Locate the machine's boom function coils on the machine's hydraulic valve.
12. Disconnect the connector from the machine's left tilt up coil.
13. Install a boom sense adapter cable (P/N 115-0171-558) between the coil and the machine's coil connector.
14. Connect boom sense adapter cables between the left tilt down, right tilt up, and right tilt down coils and to the coil connectors.
15. On the harness cable, locate the Left Solenoid Sense connectors. Isolate the connector labeled Up and connect it to the left tilt up coil via the installed boom sense adapter cable.
16. Connect the down Left Solenoid Sense connector to the left tilt down coil via the installed boom sense adapter cable.
17. Connect the Right Solenoid Sense connectors to the machine's right tilt up and right tilt down coils via the installed boom sense adapter cables.

Connect the Harness Cable to the Implement Extension Tee - Gen II Cable Only

1. Route the harness cable (P/N 115-0230-085) toward the implement extension tee cable.
2. Connect the harness cable to the To Node connector.

3. Remove the terminator from the machine's chassis harness or the standalone console harness.
4. Install the terminator on the remaining open end of the implement extension tee cable.
5. Refer to the wiring schematic (beginning on page 35) appropriate for the machine's configuration to route the implement extension tee cable.
6. Connect the implement extension tee cable to the location determined in the step above.

Connect the Harness Cable to the Controller Cable - Gen I Cable Only

1. Route the harness cable (P/N 115-0230-045) toward the machine's cab.
2. Connect the harness cable to the controller cable (P/N 115-0230-007).
3. Tighten the connector screw cap to secure the connection.

Note: *Be sure to allow enough slack in the harness cable to allow for boom racking.*

Connect the Controller (If Applicable) - Gen I Cable Only

1. Route the controller cable (P/N 115-0230-007) into the right side of the machine's cab.
2. Locate the two controller connectors and connect them to the AutoBoom controller (P/N 063-0130-021).

Note: *The AutoBoom controller should be mounted in the machine's cab so that the machine's operator has easy access to it.*

Connect the Field Computer (If Applicable)

Refer to the Installation & Operation Manual and the appropriate wiring schematic beginning on page 35 for installation and wiring instructions for your specific field computer.

Connect the Power Leads

1. Locate the power cable that has the red and white power leads at one end.
2. Disconnect the machine's connectors from the battery terminals.
3. Install the red power lead on the positive battery terminal and reinstall the machine's battery connector.
4. Install the white power lead on the negative battery terminal and reinstall the machine's battery connector.

PowerGlide Plus Wiring Schematic

Gen I Cabling

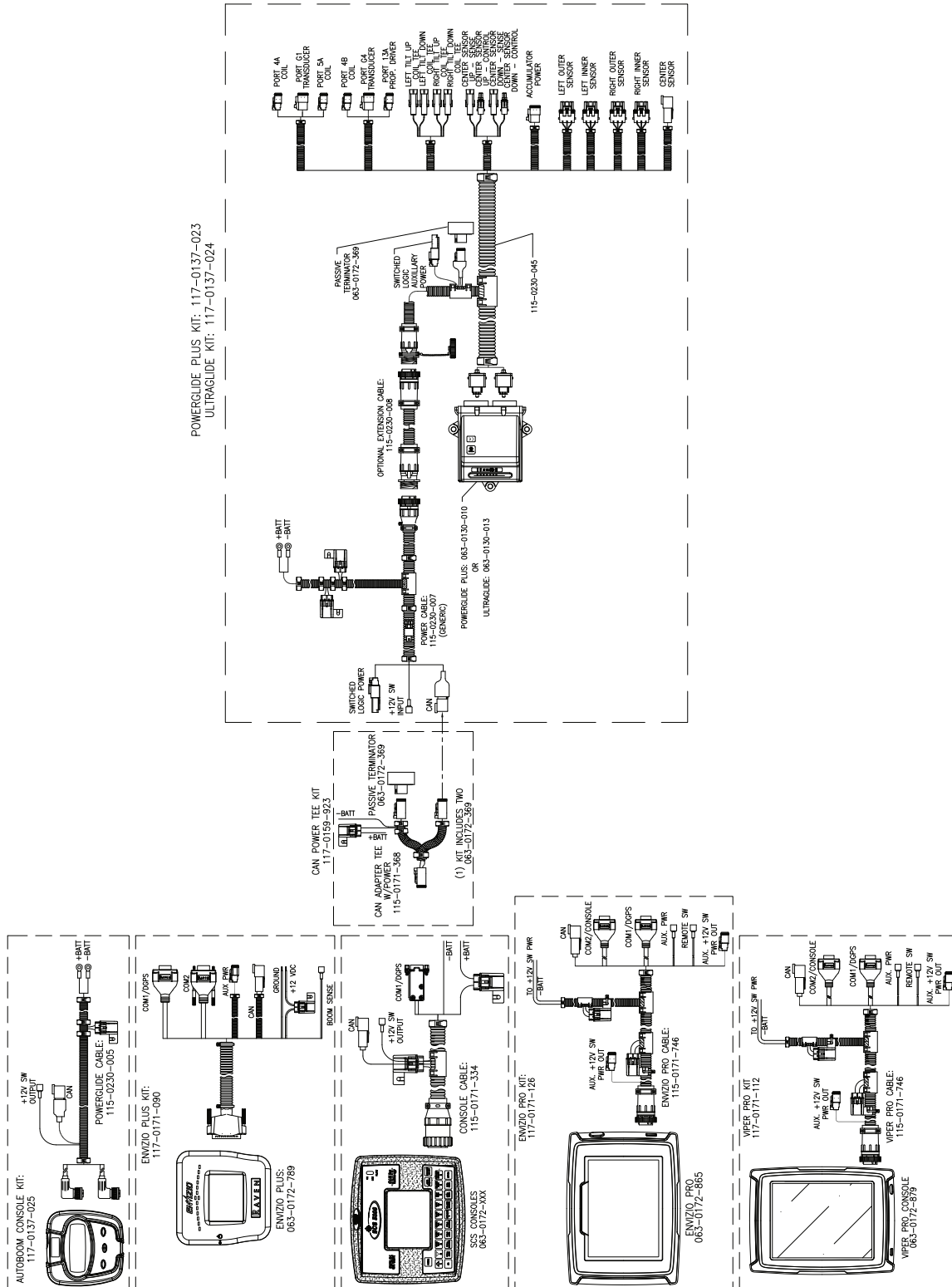

Gen II Cabling

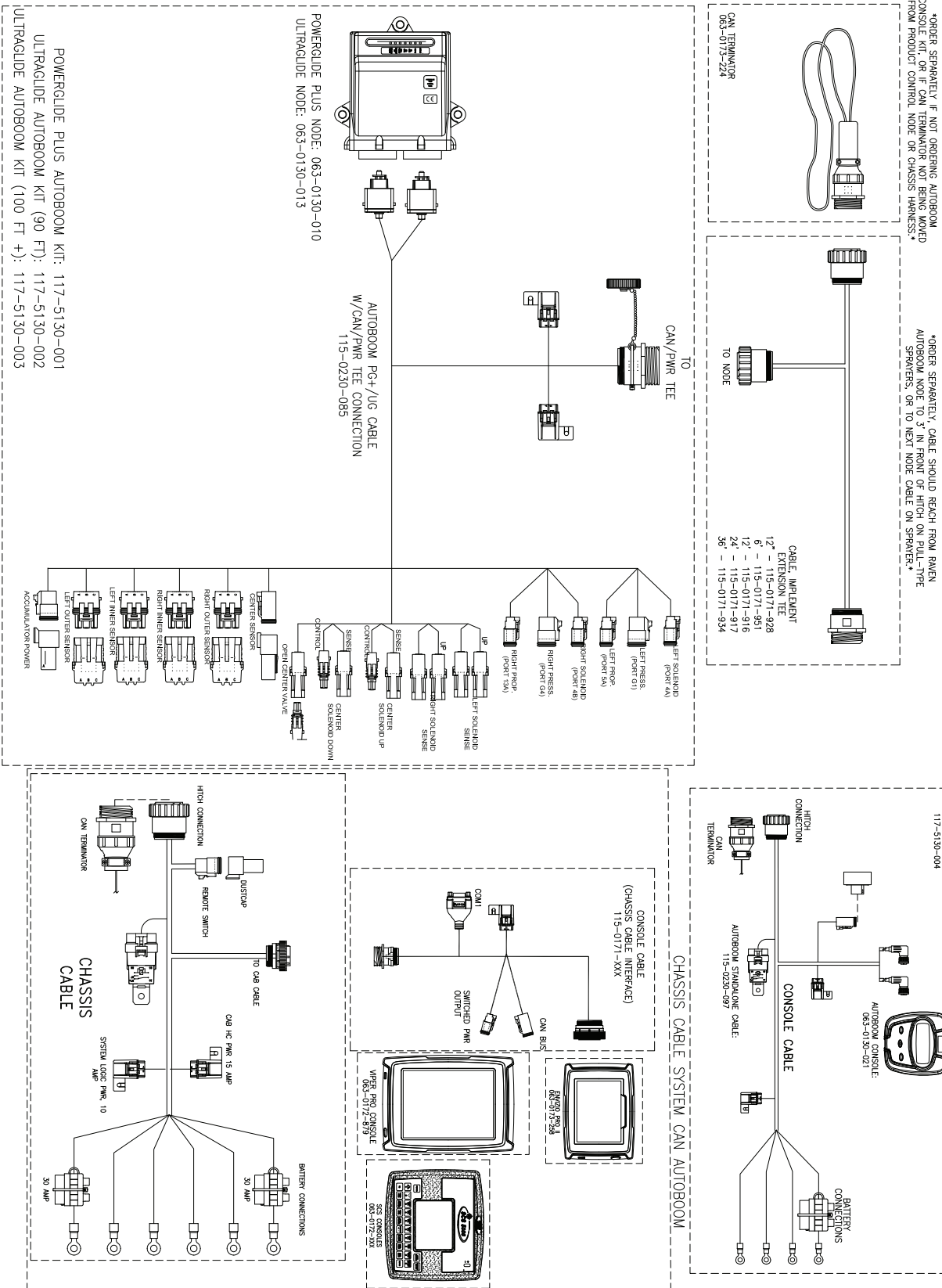

CHAPTER**5*****UltraGlide******UltraGlide Kit Contents***

This section contains a list of the components that are included in the UltraGlide AutoBoom kit. Before beginning the AutoBoom installation, compare the items in the AutoBoom kit with the components on this list. If you have questions about the kit, contact your Raven dealer.

TABLE 1. UltraGlide Installation Kit (P/N 117-0232-013)

Picture	Item Description	Part Number	Qty.
Not Pictured	Manual - Apache 2004 & Older AutoBoom Installation	016-0230-013	1
	Valve - UltraGlide AutoBoom	063-0131-124	1
	Plate - Hydraulic Block Mounting	107-0171-619	1
	Sensor - Right Ultrasonic	063-0130-012	1
	Sensor - Left Ultrasonic	063-0130-014	1
	Sensor - Center Ultrasonic	063-0130-018	1

TABLE 1. UltraGlide Installation Kit (P/N 117-0232-013)







Picture	Item Description	Part Number	Qty.
	Cable - Boom Sense Adapter	115-0171-558	4
	Cable - Weatherpack Center Rack Control Boom Sense Adapter	115-0230-037	2
	U-Bolt - 3-1/16" W x 5" L x 3/8" Thread	107-0171-607	2
	U-Bolt - 1-9/16" W x 2-1/2" L x 3/8" Thread	107-0171-611	6
	Bolt - 5/16"-18 x 7/8" Hex	311-0052-104	4
	Nut - 3/8"-16 Zinc Flanged Lock	312-1001-164	16
	Washer - 5/16" Zinc Plated Lock	313-1000-019	4

TABLE 2. Hydraulic Kit (P/N 117-0134-013)



Picture	Item Description	Part Number	Qty.
	Fitting - 9/16" JIC M/F 90° Swivel Elbow	333-0012-042	2
	Fitting - 9/16" JIC M/M/F Swivel Run Tee	333-0012-043	4
	Fitting - 9/16" JIC (M) to 9/16" SAE O-Ring (M) Straight Adapter	333-0012-045	2

TABLE 2. Hydraulic Kit (P/N 117-0134-013)





Picture	Item Description	Part Number	Qty.
	Fitting - 9/16" JIC (M) to 3/4" SAE O-Ring (M) Straight Adapter	333-0012-046	2
	Fitting - 11/16" Hex 9/16" Plug	333-0012-194	2
	Hydraulic Hose - 9/16" JIC (F) 90° to 9/16" JIC (F) - 48"	214-1000-139	2
	Hydraulic Hose - 9/16" JIC (F) 90° to 9/16" JIC (F) - 72"	214-1000-292	2

TABLE 3. Ultrasonic Sensor Bracket Installation Kit (P/N 117-0131-082)





Picture	Item Description	Part Number	Qty.
Not Pictured	Sheet - AutoBoom Sensor Extension	016-0130-070	1
	Bracket - 12" S-Type AutoBoom Sensor	063-0131-592	2
	Bolt - 5/16"-18 x 1-1/4" Hex	311-0052-106	2
	Nut - 5/16"-18 Nylon Insert Lock	312-4000-059	2
	Washer - 5/16" Zinc Flat	313-2300-012	4

TABLE 4. Optional Wheel Kit (P/N 117-0133-013)







Picture	Item Description	Part Number	Qty.
	Axle Assembly - Right Cushioned AutoBoom	063-0131-585	1
	Axle Assembly - Left Cushioned AutoBoom	063-0131-590	1
	Bracket - Left Weldment Receiver	116-0159-592	2
	Bracket - Hub Retainer	107-0171-617	2
	Wheel	322-0131-008	2
	U-Bolt - 1-9/16" W x 2-1/2" L x 3/8" Thread	107-0171-611	8
	Bolt - 1/2"-13 x 1-1/2" SS Hex	311-0058-186	4
	Nut - 1/2"-13 Zinc Hex	312-1001-043	4
	Nut - 3/8"-16 Zinc Flanged Lock	312-1001-164	16

TABLE 5. Gen I UltraGlide Wiring Kit (P/N 117-0137-024)







Picture	Item Description	Part Number	Qty.
Not Pictured	Manual - AutoBoom Calibration & Operation	016-0130-062	1
	Node - UltraGlide AutoBoom	063-0130-013	1
	Cable - Sensor	115-0171-527	2
	Cable - Harness	115-0230-045	1
	Cable - Power/CAN Controller	115-0230-007	1

TABLE 6. Gen II UltraGlide Wiring Kit (P/N 117-5130-003)

Picture	Item Description	Part Number	Qty.
Not Pictured	Manual - AutoBoom Calibration & Operation	016-0130-062	1
	Node - UltraGlide AutoBoom	063-0130-013	1
	Cable - Sensor	115-0171-527	2
	Cable - PowerGlide Plus/UltraGlide with CAN/Power Tee AutoBoom	115-0230-085	1

Important: In addition to the Gen II wiring kit components listed above, an implement extension tee cable is required for the operation of the UltraGlide AutoBoom system. For available cables and ordering information, contact your local Raven dealer.

Install Fittings on the AutoBoom Valve

Before mounting the AutoBoom valve on the machine, install the proper fittings on the valve. This prepares the valve for installation and simplifies the hose connection process later in the procedure. Refer to the following table to install the fittings in the appropriate ports on the AutoBoom valve.

Fitting	Part Number	Port
Fitting - 9/16" JIC (M) to 9/16" SAE O-Ring (M) Straight Adapter	333-0012-045	LC, RC
Fitting - 9/16" JIC M/F 90° Swivel Elbow	333-0012-042	LC, RC
Fitting - 9/16" JIC (M) to 3/4" SAE O-Ring (M) Straight Adapter	333-0012-046	P, T
Fitting - 11/16" Hex 9/16" Plug	333-0012-194	LV, RV

Mount the AutoBoom Valve

FIGURE 1. AutoBoom Valve Mounted on the Valve Mounting Plate

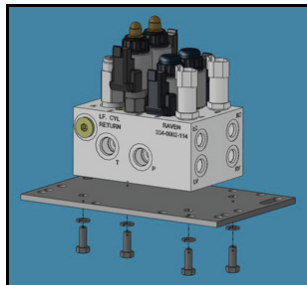

1. Secure the PowerGlide AutoBoom valve (P/N 063-0131-124) to the valve mounting plate (P/N 107-0171-619) using four 5/16" hex bolts (P/N 311-0052-104) and four 5/16" lock washers (P/N 313-1000-019).

FIGURE 2. AutoBoom Valve Mounted on the Sprayer

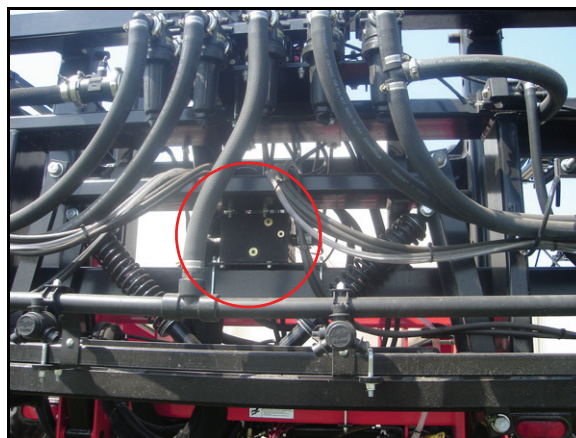

2. Secure the mounting plate on the center rack using two 3-1/16" W x 5" L x 3/8" thread U-bolts (P/N 107-0171-607) and four 3/8"-16 zinc flanged lock nuts (P/N 312-1001-164).

Install the Pressure and Tank Hoses



⚠ WARNING

Hydraulics are under pressure. Care should always be taken with a system that has been pressurized. When disconnecting or purging hydraulic hoses, be aware that the hydraulic fluid within the machine's system may be extremely hot and under high pressure.



⚠ CAUTION

When installing AutoBoom hydraulics or performing diagnostics, maintenance, or routine service, ensure precautions are taken to prevent any foreign material or contaminants from being introduced into the machine's hydraulic system.

Objects or materials that are able to bypass the machine's hydraulic filtration system will reduce performance and possibly damage the AutoBoom hydraulic valve.

FIGURE 3. Pressure and Tank Hoses Installed

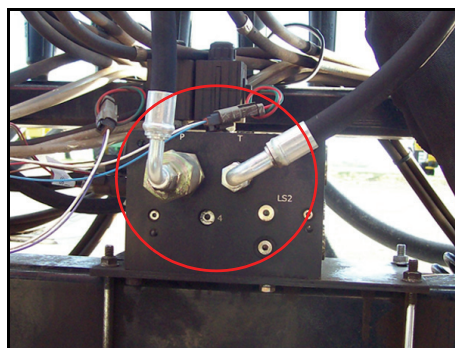

1. Disconnect the machine's pressure line from the machine's hydraulic valve (port P).
2. Install a 9/16" JIC M/M/F swivel run tee fitting (P/N 333-0012-043) in the port P of the machine's hydraulic valve.
3. Connect the machine's pressure hose to the opposite end of the installed tee fitting.
4. Install the straight end of the supplied hydraulic hose (P/N 214-1000-139) on the 90° end of the tee fitting.
5. Connect the 90° end of the installed hydraulic hose to the installed fitting in Port P of the AutoBoom valve.
6. Disconnect the machine's tank hose from the machine's hydraulic valve (port T).
7. Install a 9/16" JIC M/M/F swivel run tee fitting (P/N 333-0012-043) in port T of the machine's hydraulic valve.
8. Connect the machine's pressure hose to the opposite end of the installed tee fitting.
9. Install the straight end of the supplied hydraulic hose (P/N 214-1000-139) on the 90° end of the tee fitting.
10. Connect the 90° end of the installed hydraulic hose to the installed fitting in Port T of the AutoBoom valve.

Install the Left and Right Cylinder Hoses

FIGURE 4. Cylinder Hoses Installed on Machine's Hydraulic Valve



1. Disconnect the left and right up hoses from the machine's hydraulic valve.
2. Install a 9/16" JIC M/M/F swivel run tee fitting (P/N 333-0012-043) in the left up port of the machine's hydraulic valve.
3. Connect the machine's left up hose to the opposite end of the installed tee fitting.
4. Install the 90° end of the supplied hydraulic hose (P/N 214-1000-292) on the 90° end of the installed tee fitting.
5. Connect the straight end of the installed hydraulic hose to the installed fittings in Port LC on the AutoBoom valve.
6. Install a 9/16" JIC M/M/F swivel run tee fitting (P/N 333-0012-043) in the right up port of the machine's hydraulic valve.
7. Connect the machine's right up hose to the opposite end of the installed tee fitting.
8. Install the 90° end of the supplied hydraulic hose (P/N 214-1000-292) on the 90° end of the installed tee fitting.
9. Connect the straight end of the installed hydraulic hose to the installed fittings in Port RC of the AutoBoom valve.

UltraGlide Hydraulic Schematic

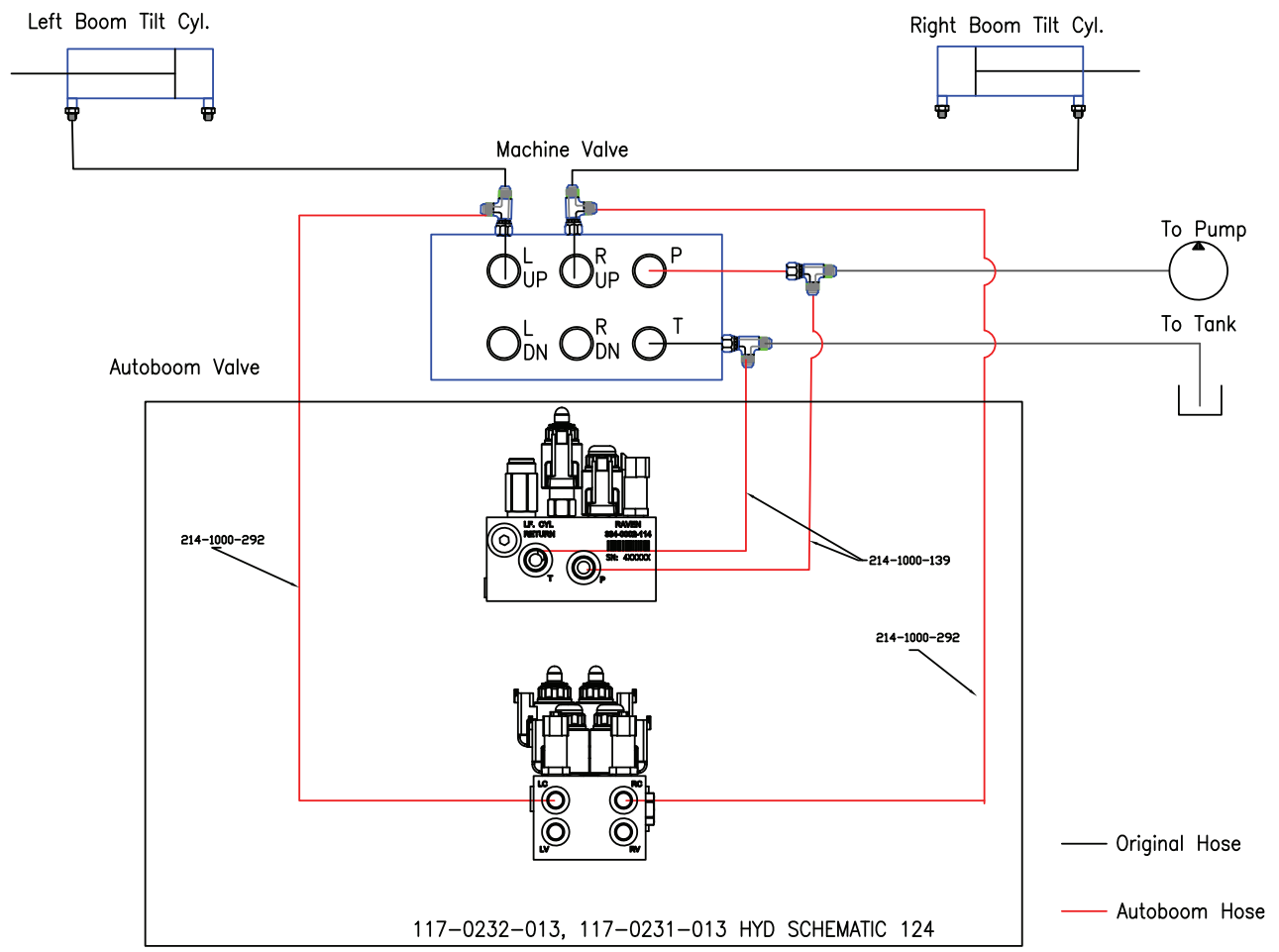

Install the UltraGlide Sensors

Boom Sensor Mounting Locations

Sensor mounting locations may be influenced by the boom configuration. If an object enters the sensor's blind range unexpectedly, a false echo return to the sensor could occur, causing the boom to drop and the sensor or boom to be damaged. To ensure optimal operation of the UltraGlide system and to protect the sprayer boom, the sensor should be mounted on the front side of the boom, 8 - 10" above the lowest hanging part of the boom.

FIGURE 5. Illustration of Sensor's Blind Range

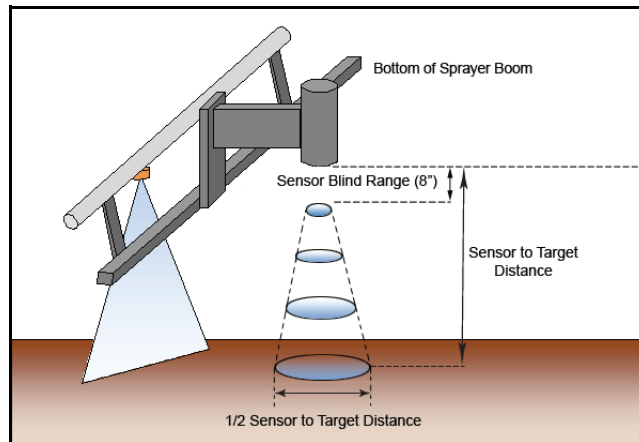

Mount the Boom Sensors

	<p>WARNING</p> <p>The machine must remain stationary and switched off, with the boom unfolded and supported, during installation or maintenance.</p>
---	---

FIGURE 6. Mounted Boom Sensors



1. Locate the left and right ultrasonic sensors (P/N 063-0130-012 and 063-0130-014) in the AutoBoom installation kit.
2. Remove the sensor from the existing plastic arm.
3. Install the sensors on the 12" S-type sensor arms (P/N 063-0131-592) using the supplied 5/16"-18 x 1-1/4" bolts (P/N 311-0052-106), 5/16"-18 nylon insert lock nuts (P/N 312-4000-059) and 5/16" zinc flat washers (P/N 313-2300-012).
4. Mount the right sensor (P/N 063-0130-012) to the front of the right boom using two 1-9/16" W x 2-1/2" L x 3/8" thread U-bolts (P/N 107-0171-611) and four 3/8"-16 zinc flanged lock nuts (P/N 312-1001-164).
5. Tighten the nuts to ensure the sensor is mounted securely.
6. Repeat the steps above to install the remaining boom sensor(s).

Mount the Center Rack Sensor

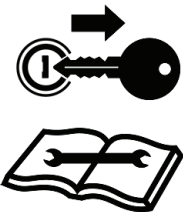
FIGURE 7. Center Sensor Mounting Location



1. Mount the center sensor (P/N 063-0130-018) to the machine's center rack using two 1-9/16" W x 2-1/2" L x 3/8" thread U-bolts (P/N 107-0171-611).
2. Secure the sensor to the center rack with four 3/8" zinc flanged lock nuts.

Connect the Sensor Cables

1. Connect the left sensor cable (P/N 115-0171-527) to the connector on the right sensor.
2. Route the right sensor cable toward the AutoBoom valve.
3. Loop and tie-off any excess cable, allowing enough cable for boom folding and extension.
4. Repeat the steps above to connect the remaining sensor cable(s).



Note: The sensor cables will be connected to the AutoBoom system in the wiring phase of installation.

Install the Gauge Wheels - Optional

Gauge Wheel Mounting Locations

Wheel mounting locations may be influenced by the boom configuration. Determine the appropriate location for mounting the wheels on the boom, ensuring the wheels will not interfere with or be damaged while folding or unfolding the booms. The wheels should be mounted outside of the boom fold, but inside the boom breakaway.

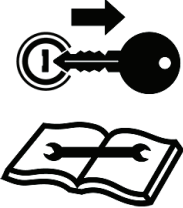
Mount the Gauge Wheels

	<div style="background-color: #e67e22; color: white; padding: 5px; text-align: center;">  WARNING </div> <p>The machine must remain stationary and switched off, with the booms unfolded and supported, during installation or maintenance.</p>
---	---

Note: The appearance of the wheel axles may vary.

FIGURE 8. Gauge Wheel Installed (Booms Folded)



1. Remove the nuts from the right wheel axle (P/N 063-0131-585).
2. Place the wheel (P/N 322-0131-008) on the right wheel axle.
3. Align and place the hub retainer bracket (P/N 107-0171-617) over the wheel.
4. Reinstall the lug nuts on the wheel axle to secure the wheel and hub retainer bracket.
5. Mount the right receiver bracket (P/N 116-0159-592) to the front of the right boom using four 1-9/16" W x 2-1/2" L x 3/8" thread U-bolts (P/N 107-0171-611) and eight 3/8"-16 zinc flanged lock nuts (P/N 312-1001-164).
6. Insert the right wheel axle into the mounting bracket, positioning it so that the bottom of the wheel touches the ground (or nearly so) and the wheel faces away from the machine.
7. Secure the gauge wheel assembly in the wheel mounting bracket by installing two 1/2"-13 x 1-1/2" SS hex bolts (P/N 311-0058-186) and two 1/2" zinc hex nuts (P/N 312-1001-043).
8. Repeat the steps above to install the left wheel.

Install the UltraGlide Wiring

Wiring Connections

	<p>⚠ CAUTION</p> <p>Always connect the power cable as the last step in the wiring process and verify that the power leads are connected with the correct polarity. Reversing power leads can cause severe damage to the equipment.</p>
---	---

For wiring connections made outside the cab, apply dielectric silicone grease (P/N 222-0000-006) generously on both the male and female ends of the connectors. Application of the grease will prevent corrosion to the pins and wires.

Install the AutoBoom Node

FIGURE 9. PowerGlide Plus AutoBoom Node Installed

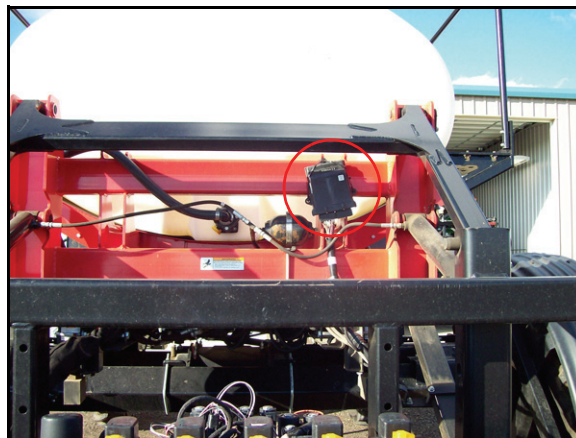

1. Mount the AutoBoom node (P/N 063-0130-013) to the machine's cross beam within close proximity to the AutoBoom valve.
2. Insert the large, rectangular node connectors on the AutoBoom harness cable (P/N 115-0230-045) into the correct ports of the AutoBoom valve.
3. Tighten the bolts on the node connectors to secure the connections.



Connect the Harness to the Boom Function Controls

1. Locate the Left Press and Right Press connectors on the harness cable (P/N 115-0230-045 or 115-0230-085).
2. Route the connectors to the AutoBoom valve (P/N 063-0131-124).
3. Connect the Left Press connector to Port G1 on the AutoBoom valve.
4. Connect the Right Press connector to Port G4 on the AutoBoom valve.
5. Locate the Left Solenoid and Right Solenoid connectors on the harness cable.
6. Connect the Left Solenoid connector to Port 4A on the AutoBoom valve.
7. Connect the Right Solenoid connector to Port 4B on the AutoBoom valve.
8. Locate the Left Prop and Right Prop connectors on the harness cable.
9. Connect the Left Prop connector to Port 5A on the AutoBoom valve.
10. Connect the Right Prop connector to Port 13A on the AutoBoom valve.

FIGURE 10. Machine's Left and Right Tilt Boom Function Coils

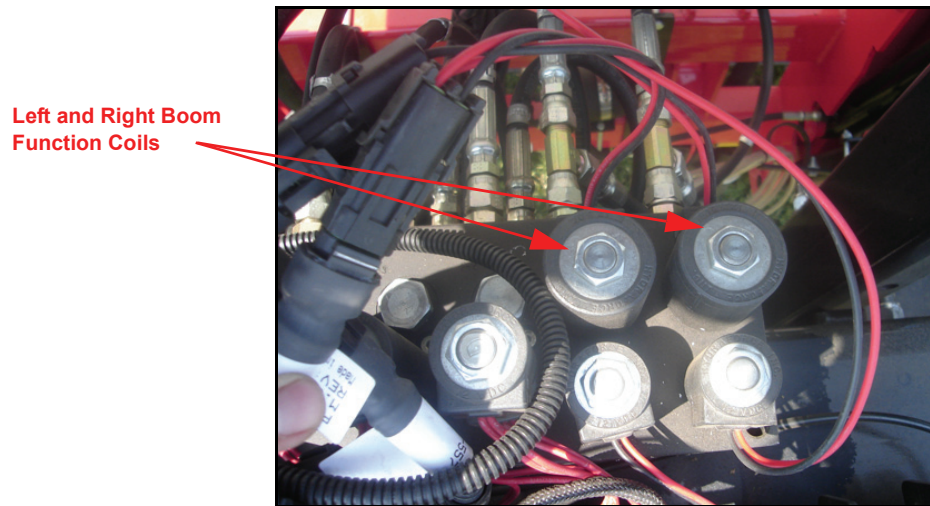

11. Locate the machine's boom function coils on the machine's hydraulic valve.
12. Disconnect the connector from the machine's left tilt up coil.
13. Install a boom sense adapter cable (P/N 115-0171-558) between the coil and the machine's coil connector.
14. Connect boom sense adapter cables between the left tilt down, right tilt up, and right tilt down coils and to the coil connectors.
15. On the harness cable, locate the Left Solenoid Sense connectors. Isolate the connector labeled Up and connect it to the left tilt up coil via the installed boom sense adapter cable.
16. Connect the down Left Solenoid Sense connector to the left tilt down coil via the installed boom sense adapter cable.
17. Connect the Right Solenoid Sense connectors to the machine's right tilt up and right tilt down coils via the installed boom sense adapter cables.

Install the Center Rack Control - Model Year 2002-2004 Only

FIGURE 11. Machine's Center Up/Down Coils

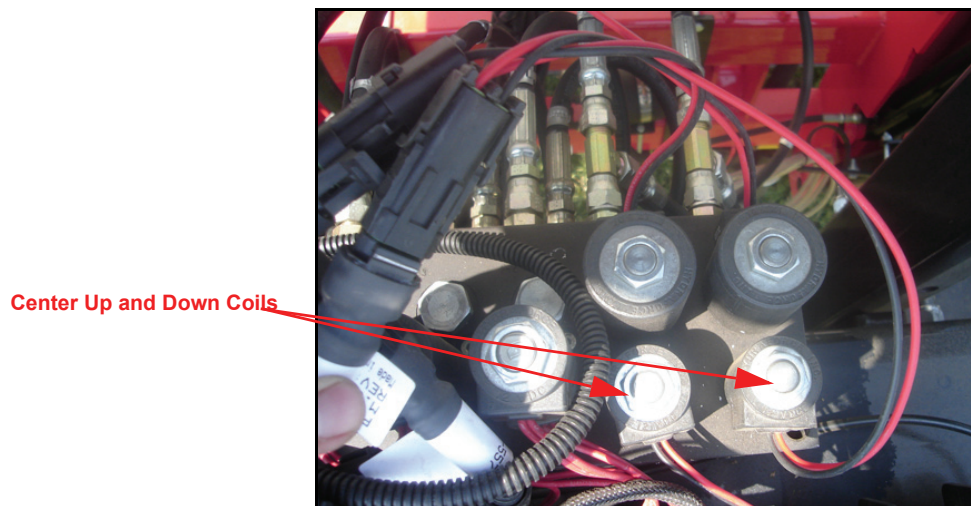

1. Locate the Center Up coil on the machine's hydraulic valve.
2. Unplug the coil connector from the Center Up coil.
3. Install a center rack control boom sense adapter cable (P/N 115-0230-037) on the machine's Up coil.
4. Connect the coil connector to the installed boom sense adapter cable.
5. Plug the single connectors on the installed boom sense adapter cable in the Center Up harness connectors on the AutoBoom harness cable (P/N 115-0230-045 or 115-0230-085).
6. Locate the Center Down coil on the machine's hydraulic valve.
7. Unplug the coil connector from the Center Down coil.
8. Install a center rack control boom sense adapter cable (P/N 115-0230-037) on the machine's Down coil.
9. Connect the coil connector to the installed boom sense adapter cable.
10. Plug the single connectors on the installed boom sense adapter cable in the Center Down harness connectors on the AutoBoom harness cable.

Connect the Harness Cable to the Sensors

1. Locate the Center Sensor connector on the AutoBoom harness cable.
2. Connect the Center Sensor connector to the installed center sensor (P/N 063-0130-018).

Note: On machines 2001 and older, the center sensor will allow the center height to be displayed, but will not allow center rack control.

3. Locate the Left Outer Sensor connector on the AutoBoom harness cable.
4. Connect the Left Outer Sensor connector to the installed left sensor cable (P/N 115-0171-527).
5. Locate the Right Outer Sensor connector on the AutoBoom harness cable.
6. Connect the Right Outer Sensor connector to the installed right sensor cable.
7. If optional inside boom sensors are installed, repeat the steps above to connect the sensors.



Connect the Harness Cable to the Implement Extension Tee - Gen II Cable Only

1. Route the harness cable (P/N 115-0230-085) toward the implement extension tee cable.
2. Connect the harness cable to the To Node connector.
3. Remove the terminator from the machine's chassis harness or the standalone console harness.
4. Install the terminator on the remaining open end of the implement extension tee cable.
5. Refer to the wiring schematic (beginning on page 53) appropriate for the machine's configuration to route the implement extension tee cable.
6. Connect the implement extension tee cable to the location determined in the step above.

Connect the Harness Cable to the Controller Cable - Gen I Cable Only

1. Route the harness cable (P/N 115-0230-045) toward the machine's cab.
2. Connect the harness cable to the controller cable (P/N 115-0230-007).
3. Tighten the connector screw cap to secure the connection.

Note: *Be sure to allow enough slack in the harness cable to allow for boom racking.*

Connect the Controller (If Applicable) - Gen I Cable Only

1. Route the controller cable (P/N 115-0230-007) into the right side of the machine's cab.
2. Locate the two controller connectors and connect them to the AutoBoom controller (P/N 063-0130-021).

Note: *The AutoBoom controller should be mounted in the machine's cab so that the machine's operator has easy access to it.*

Connect the Field Computer (If Applicable)

Refer to the Installation & Operation Manual and the appropriate wiring schematic beginning on page 53 for installation and wiring instructions for your specific field computer.

Connect the Power Leads

1. Locate the power cable that has the red and white power leads at one end.
2. Disconnect the machine's connectors from the battery terminals.
3. Install the red power lead on the positive battery terminal and reinstall the machine's battery connector.
4. Install the white power lead on the negative battery terminal and reinstall the machine's battery connector.

UltraGlide Wiring Schematic

Gen I Cabling

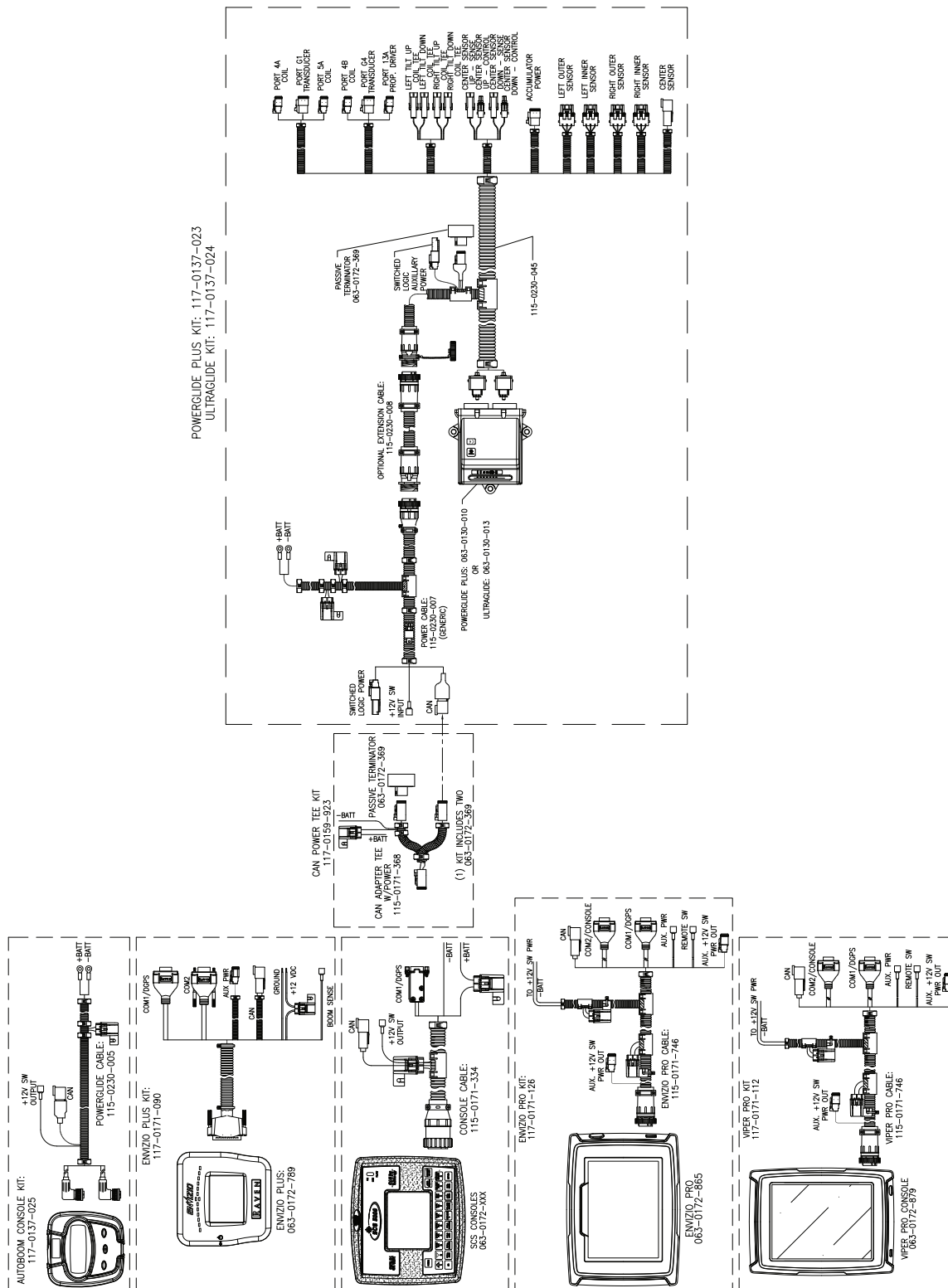

Gen II Cabling

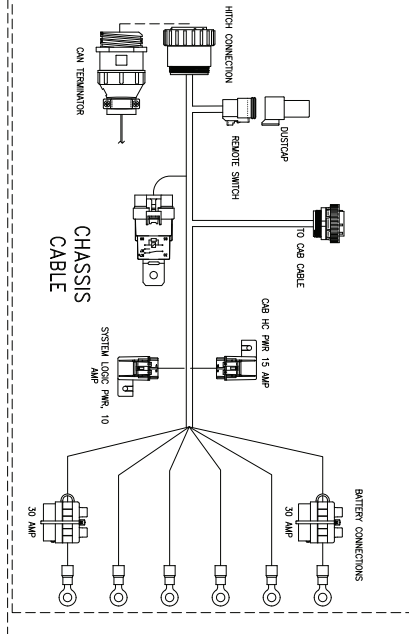
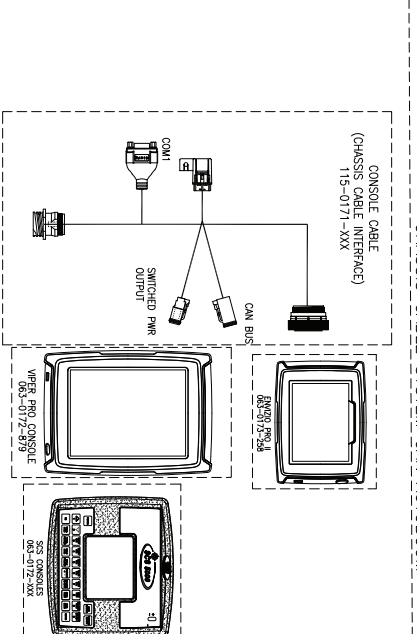
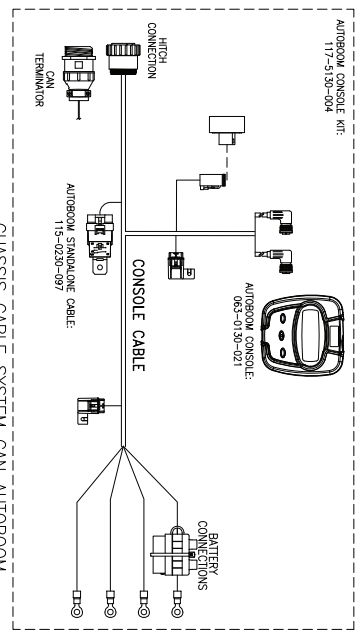
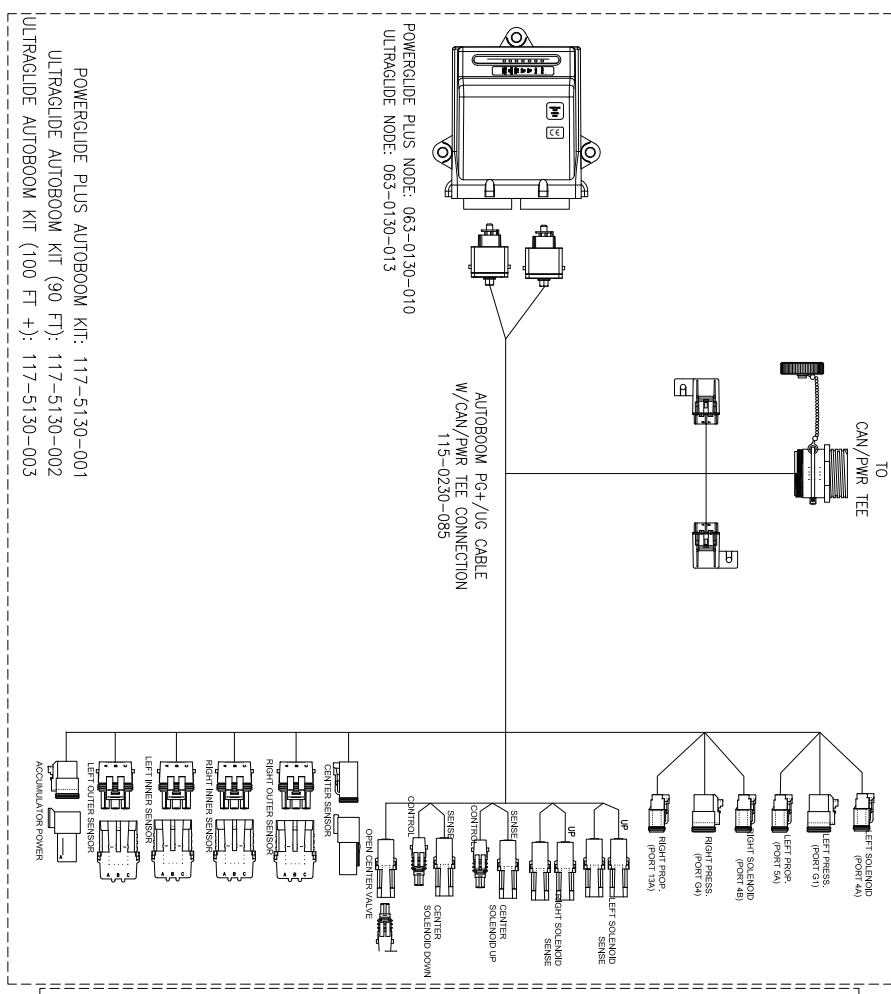
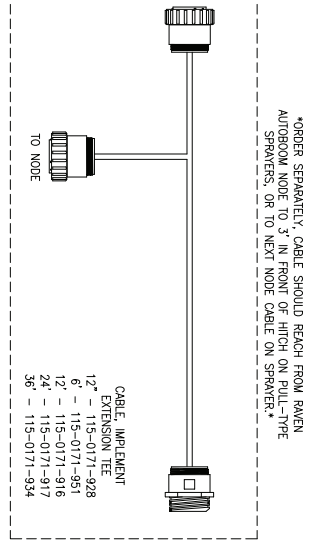
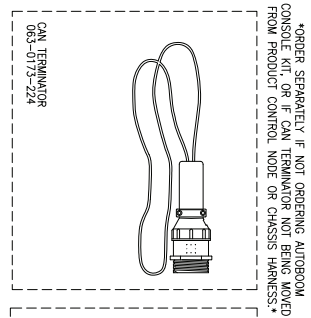

CHAPTER

6

Replacement Parts

This section contains replacement part diagrams for PowerGlide, PowerGlide Plus, and UltraGlide systems. Please refer to these diagrams when calling to request replacement parts.

Valve Blocks

PowerGlide Block Replacement Parts

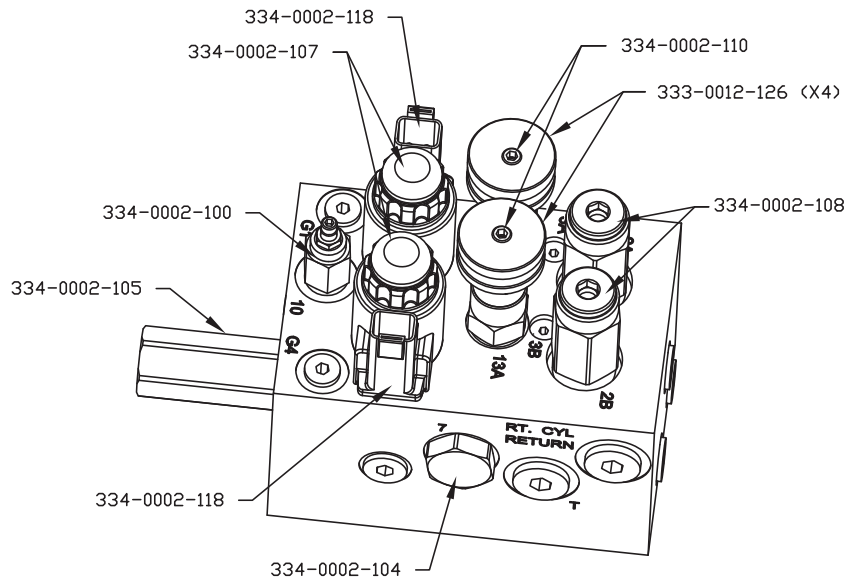

063-0131-127
VALVE, HYDRAULIC POWERGLIDE,
OPEN CENTER, AUTOBOOM

PowerGlide Plus and UltraGlide Valve Block Replacement Parts

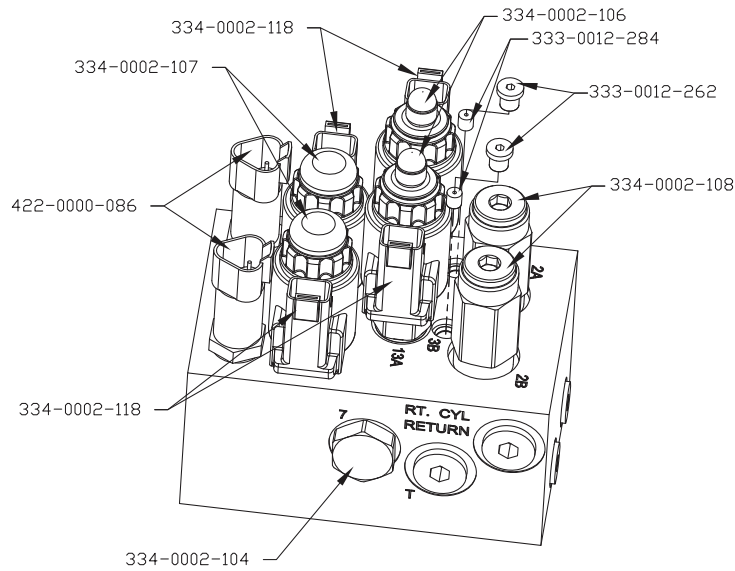

063-0131-124
VALVE, HYDRAULIC POWERGLIDE
PLUS/ULTRAGLIDE, CLOSED CENTER, AUTOBOOM

Wheels

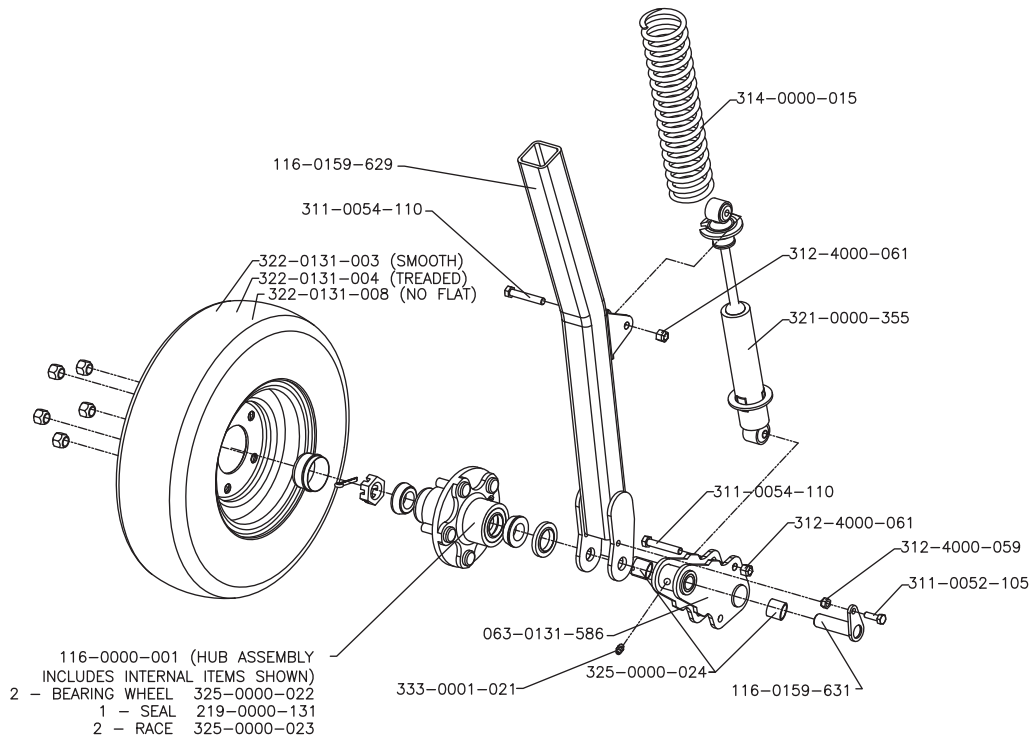

Sensors

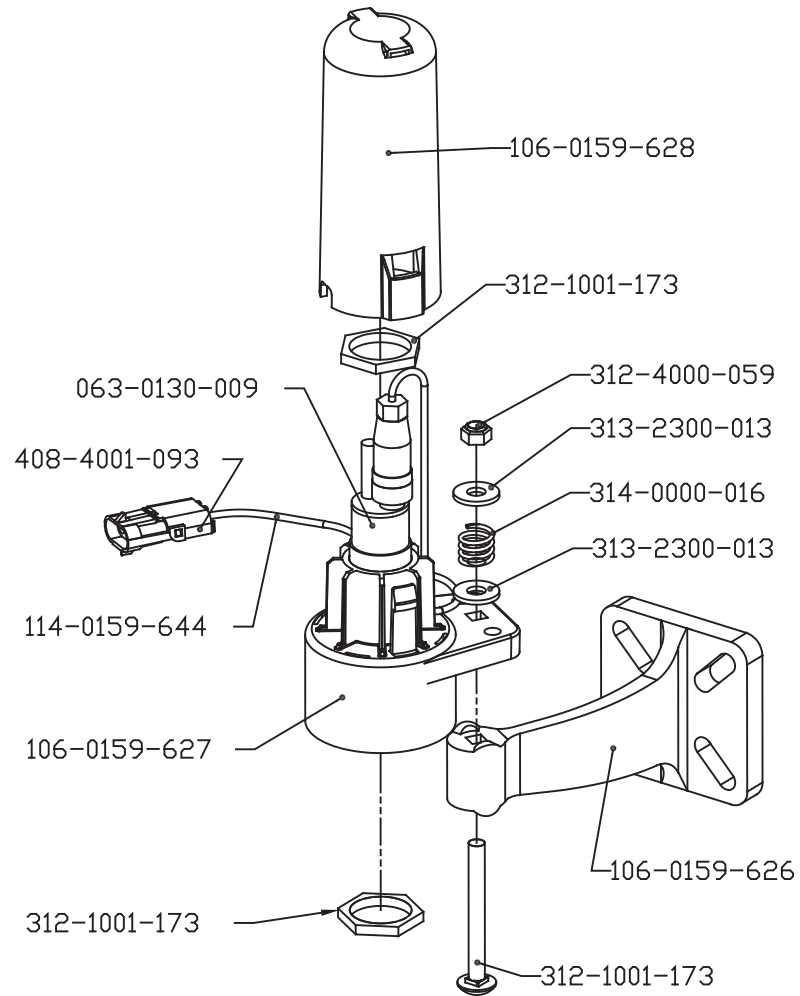

H**Hydraulic**

- Fittings 4
- Safety 2

I**Important Safety Information**

- Electrical Safety 2
- Hydraulic Safety 2

Introduction

- Hydraulic Fittings 4
- Preparing for Installation 4
 - Point of Reference 4
 - Recommendations 4
 - Tools Needed 4

K**Kit Contents**

- PowerGlide 7
- PowerGlide Plus 19
- UltraGlide 37

P**Point of Reference 4****PowerGlide 7**

- Install
 - Gauge Wheels 15
 - Gauge Wheel Mounting Locations 15
 - Mounting the Gauge Wheels 15
 - Hydraulic System
 - Hydraulic Schematic 14
 - Installing Fittings on AutoBoom Valve 10
 - Installing the Left and Right Cylinder Hoses 13
 - Installing the Pressure and Tank Hoses 12
 - Mounting the AutoBoom Valve 11
 - Wiring 16
 - Connecting the Controller 17
 - Connecting the Harness Cable to the Controller Cable 17
 - Connecting the Harness to Boom Function Controls 16
 - Connecting the Power Leads 17
 - Wiring Connections 16
 - Wiring Schematic
 - AutoBoom Controller 18

- Kit Contents 7

PowerGlide Plus

- Install
 - Gauge Wheels 31
 - Gauge Wheel Mounting Locations 31
 - Mounting the Gauge Wheels 31
 - Hydraulic System 23
 - Hydraulic Schematic 30
 - Installing Fittings on AutoBoom Valve 26
 - Installing the Left and Right Cylinder Hoses 28
 - Installing the Pressure and Tank Hoses 27
 - Mounting the AutoBoom Valve 26
 - Removing the Orifice Fittings 23
 - Wiring 32
 - Connecting the Controller 34
 - Connecting the Field Computer 34

- Connecting the Harness Cable to the Controller Cable 33
- Connecting the Harness Cable to the Controller Cable - Gen I Cable Only 34
- Connecting the Harness Cable to the Implement Extension Tee - Gen II Cable Only 33
- Connecting the Harness to Boom Function Controls 33
- Connecting the Power Leads 34
- Installing the AutoBoom Node 32
- Wiring Connections 32
- Wiring Schematics
 - Gen I Cabling 35
 - Gen II Cabling 36

- Kit Contents 19

Preparing for Installation 4**R****Recommendations 4****Replacement Parts 55**

- Sensors 57
- Valve Blocks 55
 - PowerGlide 55
 - PowerGlide Plus and UltraGlide 56
- Wheels 56

T**Tools Needed 4****U****UltraGlide 37**

- Install
 - Gauge Wheels 48
 - Gauge Wheel Mounting Locations 48
 - Mounting the Gauge Wheels 48
 - Hydraulic System
 - Hydraulic Schematic 45
 - Installing Fittings on AutoBoom Valve 42
 - Installing the Left and Right Cylinder Hoses 44
 - Installing the Pressure and Tank Hoses 43
 - Mounting the AutoBoom Valve 42
 - Sensors 46
 - Boom Sensor Mounting Locations 46
 - Connecting Sensor Cables 47
 - Mounting Center Rack Sensor 47
 - Mounting the Boom Sensors 46
 - Wiring 49
 - Connecting the Controller 52
 - Connecting the Field Computer 52
 - Connecting the Harness Cable to the Controller Cable - Gen I Cable Only 52
 - Connecting the Harness Cable to the Implement Extension Tee - Gen II Cable Only 52
 - Connecting the Harness Cable to the Sensors 51
 - Connecting the Harness to Boom Function Controls 50
 - Connecting the Power Leads 52
 - Installing the AutoBoom Node 49
 - Installing the Center Rack Control 51
 - Wiring Connections 49
 - Wiring Schematics
 - Gen I Cabling 53

Gen II Cabling 54
Kit Contents 37

RAVEN

RAVEN INDUSTRIES

Limited Warranty

What Does this Warranty Cover?

This warranty covers all defects in workmanship or materials in your Raven Applied Technology Division product under normal use, maintenance, and service.

How Long is the Coverage Period?

Raven Applied Technology Division products are covered by this warranty for 12 months after the date of purchase. This warranty coverage applies only to the original owner and is nontransferable.

How Can I Get Service?

Bring the defective part and proof of purchase to your Raven dealer. If your dealer agrees with the warranty claim, the dealer will send the part and proof of purchase to their distributor or to Raven Industries for final approval.

What Will Raven Industries Do?

Upon confirmation of the warranty claim, Raven Industries will, at our discretion, repair or replace the defective part and pay for return freight.

What is not Covered by this Warranty?

Raven Industries will not assume any expense or liability for repairs made outside our facilities without written consent. Raven Industries is not responsible for damage to any associated equipment or products and will not be liable for loss of profit or other special damages. The obligation of this warranty is in lieu of all other warranties, expressed or implied, and no person or organization is authorized to assume any liability for Raven Industries.

Damages caused by normal wear and tear, misuse, abuse, neglect, accident, or improper installation and maintenance are not covered by this warranty.