

**Flexi-Coil 2007 - 068 Series  
Case IH SRX Series  
New Holland 216 Series - 120'-134'  
Boom  
AutoBoom™ Installation Manual**

*P/N 016-0230-071 Rev C*

*09/15*

*E18370*

## ***Disclaimer***

---

While every effort has been made to ensure the accuracy of this document, Raven Industries assumes no responsibility for omissions and errors. Nor is any liability assumed for damages resulting from the use of information contained herein.

Raven Industries shall not be responsible or liable for incidental or consequential damages or a loss of anticipated benefits or profits, work stoppage or loss, or impairment of data arising out of the use, or inability to use, this system or any of its components. Raven Industries shall not be held responsible for any modifications or repairs made outside our facilities, nor damages resulting from inadequate maintenance of this system.

As with all wireless and satellite signals, several factors may affect the availability and accuracy of wireless and satellite navigation and correction services (e.g. GPS, GNSS, SBAS, etc.). Therefore, Raven Industries cannot guarantee the accuracy, integrity, continuity, or availability of these services and cannot guarantee the ability to use Raven systems, or products used as components of systems, which rely upon the reception of these signals or availability of these services. Raven Industries accepts no responsibility for the use of any of these signals or services for other than the stated purpose.

<b>Chapter 1</b>	<b><i>Important Safety Information</i></b> .....	<b>1</b>
	Hydraulic Safety .....	2
	Electrical Safety .....	2
<b>Chapter 2</b>	<b><i>Introduction</i></b> .....	<b>3</b>
	Introduction .....	3
	Recommendations .....	4
	Preparing for Installation .....	4
	Point of Reference .....	4
	Hydraulic Fittings .....	4
<b>Chapter 3</b>	<b><i>PowerGlide</i></b> .....	<b>5</b>
	PowerGlide Kit Contents .....	5
	Install the PowerGlide Hydraulic System .....	8
	Convert the Sprayer's Hydraulic Valve to Open Center (If Applicable) .....	9
	Install Fittings on the AutoBoom Valve .....	9
	Mount the AutoBoom Valve .....	10
	Install the Pressure and Tank Hoses .....	11
	Install the Left and Right Cylinder Hoses .....	12
	PowerGlide Hydraulic Schematic .....	14
	Install the Gauge Wheels .....	15
	Mount the Gauge Wheels .....	15
	Install the PowerGlide Wiring .....	16
	Connect the Harness Cable to the Boom Function Controls .....	16
	Connect the Harness Cable .....	17
	Connect the Controller .....	17
	Connect the Power Leads .....	17
	PowerGlide Wiring Schematic .....	18
<b>Chapter 4</b>	<b><i>PowerGlide Plus</i></b> .....	<b>19</b>
	PowerGlide Plus Kit Contents .....	19
	Install the PowerGlide Plus Hydraulic System .....	23
	Convert the Sprayer's Hydraulic Valve to Open Center (If Applicable) .....	23
	Remove the Orifice Fittings .....	24
	Install Fittings on the AutoBoom Valve .....	26
	Mount the AutoBoom Valve .....	27
	Install the Pressure and Tank Hoses .....	28
	Install the Left and Right Cylinder Hoses .....	29
	PowerGlide Plus Hydraulic Schematic .....	31
	Install the Gauge Wheels .....	32
	Gauge Wheel Mounting Locations .....	32
	Install the PowerGlide Plus Wiring .....	33

Install the AutoBoom Node .....	33
Connect the Harness Cable to the Boom Function Controls .....	33
Connect the Harness Cable to the Implement Extension Tee - Gen II Cable Only .....	34
Connect the Harness Cable to the Controller Cable - Gen I Cable Only .....	35
Connect the Controller (If Applicable) - Gen I Cable Only .....	35
Connect the Field Computer (If Applicable) .....	35
Connect the Power Leads .....	35
PowerGlide Plus Wiring Schematic .....	36
Gen I Cabling .....	36
Gen II Cabling .....	37

**Chapter 5    *UltraGlide* .....**    **39**

UltraGlide Kit Contents .....	39
Install the UltraGlide Hydraulic System .....	43
Convert the Sprayer's Hydraulic Valve to Open Center (If Applicable) .....	44
Install Fittings on the AutoBoom Valve .....	44
Mount the AutoBoom Valve .....	45
Install the Pressure and Tank Hoses .....	46
Install the Left and Right Cylinder Hoses .....	47
UltraGlide Hydraulic Schematic .....	49
Boom Sensor Mounting Locations .....	50
Mount the Center Rack Sensor .....	51
Connect the Sensor Cables .....	52
Install the Gauge Wheels - Optional .....	53
Gauge Wheel Mounting Locations .....	53
Install the UltraGlide Wiring .....	54
Install the AutoBoom Node .....	54
Connect the Harness Cable to the Boom Function Controls .....	54
Install the Center Rack Control .....	56
Connect the Harness Cable to the Sensors .....	57
Connect the Harness Cable to the Implement Extension Tee - Gen II Cable Only .....	57
Connect the Harness Cable to the Controller Cable - Gen I Cable Only .....	57
Connect the Controller (If Applicable) - Gen I Cable Only .....	57
Connect the Field Computer (If Applicable) .....	57
Connect the Power Leads .....	58
UltraGlide Wiring Schematic .....	59
Gen I Cabling .....	59
Gen II Cabling .....	60

**Chapter 6    *Replacement Parts* .....**    **61**

PowerGlide Valve Block Replacement Parts .....	61
PowerGlide Plus and UltraGlide Valve Block Replacement Parts .....	62
Wheels .....	62

Sensors ..... 63



---

## CHAPTER

# 1

# *Important Safety Information*

---

## NOTICE

Read this manual and the operation and safety instructions included with your implement and/or controller carefully before installing the AutoBoom™ system.

- Follow all safety information presented within this manual.
- If you require assistance with any portion of the installation or service of your Raven equipment, contact your local Raven dealer for support.
- Follow all safety labels affixed to the AutoBoom system components. Be sure to keep safety labels in good condition and replace any missing or damaged labels. To obtain replacements for missing or damaged safety labels, contact your local Raven dealer.

When operating the machine after installing AutoBoom, observe the following safety measures:

- Be alert and aware of surroundings.
- Do not operate AutoBoom or any agricultural equipment while under the influence of alcohol or an illegal substance.
- Remain in the operator's position in the machine at all times when AutoBoom is engaged.
- Disable AutoBoom when exiting from the operator's seat and machine.
- Do not drive the machine with AutoBoom enabled on any public road.
- Determine and remain a safe working distance from other individuals. The operator is responsible for disabling AutoBoom when the safe working distance has diminished.
- Ensure AutoBoom is disabled prior to starting any maintenance work on AutoBoom or the machine.

## **WARNING**

- When starting the machine for the first time after installing AutoBoom, be sure that all persons stand clear, in case a hose has not been properly tightened.
- The machine must remain stationary and switched off, with the booms unfolded and supported, during installation or maintenance.

 **CAUTION**

---

## ***Hydraulic Safety***

- Raven Industries recommends that appropriate protective equipment be worn at all times when working on the hydraulic system.
- Never attempt to open or work on a hydraulic system with the equipment running. Care should always be taken when opening a system that has been previously pressurized.
- When disconnecting the hydraulic hoses or purging is required, be aware that the hydraulic fluid may be extremely hot and under high pressure. Caution must be exercised.
- Any work performed on the hydraulic system must be done in accordance with the machine manufacturer's approved maintenance instructions.
- When installing AutoBoom hydraulics or performing diagnostics, maintenance, or routine service, ensure that precautions are taken to prevent any foreign material or contaminants from being introduced into the machine's hydraulic system. Objects or materials that are able to bypass the machine's hydraulic filtration system will reduce performance and possibly damage the AutoBoom hydraulic valve.

---

## ***Electrical Safety***

- Always verify that the power leads are connected to the correct polarity as marked. Reversing the power leads could cause severe damage to the equipment.
- Ensure that the power cable is the last cable to be connected.



---

## CHAPTER

# 2

## *Introduction*

---

### *Introduction*

Congratulations on your purchase of the Raven AutoBoom system! This system is designed to provide automated boom height adjustment for agricultural spraying equipment.

This manual applies to the following machines. For future reference, write your serial number in the space below.

**MAKE:** Flexi-Coil, CaseIH & New Holland - 120'-134' Boom

**MODEL:** Flexi-Coil 2007 68 Series, CaseIH SRX Series, New Holland 216

**YEAR:**

**SERIAL NUMBER:**

FIGURE 1. CaseIH SRX Series

---



**Note:** This manual contains the installation instructions for the PowerGlide, PowerGlide Plus, and UltraGlide systems. Be sure to identify which system you have and follow only the instructions for that system.

## Recommendations

Raven Industries recommends the following best practices when installing the AutoBoom system:

- Use part numbers to identify the parts.
- Do not remove the plastic wrap from a part until it is necessary for installation.
- Do not remove plastic caps from a part until it is necessary for installation.

## Tools Needed

The following tools are recommended for installation of the AutoBoom system:

- SAE standard-sized wrenches
- Cable ties
- Set of tools

## Preparing for Installation

Before installing AutoBoom, park the machine where the ground is level, clean, and dry. Leave the machine turned off for the duration of the installation process.

During the installation process, follow good safety practices. Be sure to carefully read the instructions in this manual as you complete the installation process.

## Point of Reference

The instructions in this manual assume that you are standing behind the machine, looking toward the cab.

## Hydraulic Fittings

This manual may reference the following types of hydraulic fittings:

- SAE O-ring fittings
- ORFS (O-Ring Face Seal) fittings
- JIC fittings

SAE O-ring fitting



ORFS fitting



JIC fitting (M)



## CHAPTER

# 3





# PowerGlide

## PowerGlide Kit Contents

This section contains a list of the components that are included in the PowerGlide AutoBoom kit. Before beginning the AutoBoom installation, compare the items in the AutoBoom kit with the components on this list. If you have questions about the kit, contact your Raven dealer.

**Note:** *In addition to the following kit components, an axle kit is required for the operation of the PowerGlide AutoBoom system. For available kits and ordering information, contact your local Raven dealer.*

TABLE 1. PowerGlide Installation Kit (P/N 117-0230-071)

Picture	Item Description	Part Number	Qty.
Not Pictured	Manual - 2007 Flexi-Coil 68 Series & CaseIH SRX Series 120' - 134' Boom	016-0230-071	1
	Valve - PowerGlide AutoBoom	063-0131-127	1
	Plate - Hydraulic Block Mounting	107-0171-619	1
	Cable - Boom Sense Adapter	115-0171-546	4
	Cable - PowerGlide/PowerGlide Plus/ UltraGlide Extension	115-0230-008	1

**TABLE 1. PowerGlide Installation Kit (P/N 117-0230-071)**

Picture	Item Description	Part Number	Qty.
	Bracket - 2007 Flexi-Coil 120', 134' Weldment	116-0159-658	2
	Wheel	322-0131-008	2
	U-Bolt - 4" W x 5" L x 3/8" Thread	107-0171-606	2
	U-Bolt - 2-1/16" W x 3" L x 3/8" Thread	107-0171-609	8
	Bolt - 5/16"-18 x 7/8" Hex	311-0052-104	4
	Bolt - 1/2"-13 x 1-1/2" SS Hex	311-0058-186	4
	Nut - 1/2"-13 Zinc Hex	312-1001-043	4
	Nut - 3/8"-16 Zinc Flanged Lock	312-1001-164	20
	Washer - 5/16" Zinc Plated Lock	313-1000-019	4

TABLE 2. Hydraulic Kit (P/N 117-0134-071)

Picture	Item Description	Part Number	Qty.
	Fitting - 3/4" JIC M/M/F Swivel Run Tee Adapter	333-0012-039	1
	Fitting - 9/16" JIC M/F 90° Swivel Elbow	333-0012-042	2
	Fitting - 9/16" JIC (M) to 9/16" SAE O-Ring (M) Straight Adapter	333-0012-045	4
	Fitting - 3/4" SAE O-Ring (M) to 3/4" JIC (M) Straight Adapter	333-0012-093	3
	Hydraulic Hose - 9/16" JIC (F) to 9/16" JIC 90° (F) - 132"	214-1000-291	1
	Hydraulic Hose - 9/16" JIC (F) to 9/16" JIC 90° (F) - 114"	214-1000-295	1
	Hydraulic Hose - 3/4" JIC (F) to 3/4" JIC 90° (F) - 38"	214-1000-432	2
	Hydraulic Hose - 3/4" JIC (M) to 3/4" JIC (F) - 36"	214-1000-592	1

TABLE 3. PowerGlide Wiring Kit (P/N 117-0137-022)



Picture	Item Description	Part Number	Qty.
Not Pictured	Manual - AutoBoom Operator's	016-0130-061	1
	AutoBoom PowerGlide Controller	063-0130-011	1

TABLE 3. PowerGlide Wiring Kit (P/N 117-0137-022)

Picture	Item Description	Part Number	Qty.
	Cable - AutoBoom Controller	115-0230-002	1
	Cable - AutoBoom Valve Harness	115-0230-003	1

## Install the PowerGlide Hydraulic System

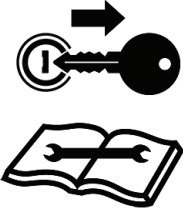

⚠ **WARNING**

The machine must remain stationary and switched off, with the booms unfolded and supported, during installation or maintenance.



⚠ **CAUTION**

When installing AutoBoom hydraulics or performing diagnostics, maintenance, or routine service, ensure precautions are taken to prevent any foreign material from being introduced into the machine's hydraulic system.

Objects or materials that are able to bypass the machine's hydraulic filtration system will reduce performance and possibly damage the AutoBoom hydraulic valve.



**NOTICE**

The appearance of the AutoBoom hydraulic valve may vary slightly from the images contained in this manual. However, the fittings, hose connections, and cable connections remain the same.

## Convert the Sprayer's Hydraulic Valve to Open Center (If Applicable)

By factory default, the machine's main hydraulic valve is configured as an "open center" hydraulic system. However, if the hydraulic valve has been converted to a "closed center" system, it will have to be changed back to the "open center" configuration. Complete the following steps to convert the machine's hydraulic system from a "closed center" to "open center" system.

**Note:** *The machine came equipped from the factory with a master open center coil that is necessary to convert the hydraulic valve. If the master open center coil has been misplaced, a replacement must be obtained from the dealer from whom the machine was purchased.*

**FIGURE 1. Converted Hydraulic Valve - Closed Center to Open Center**

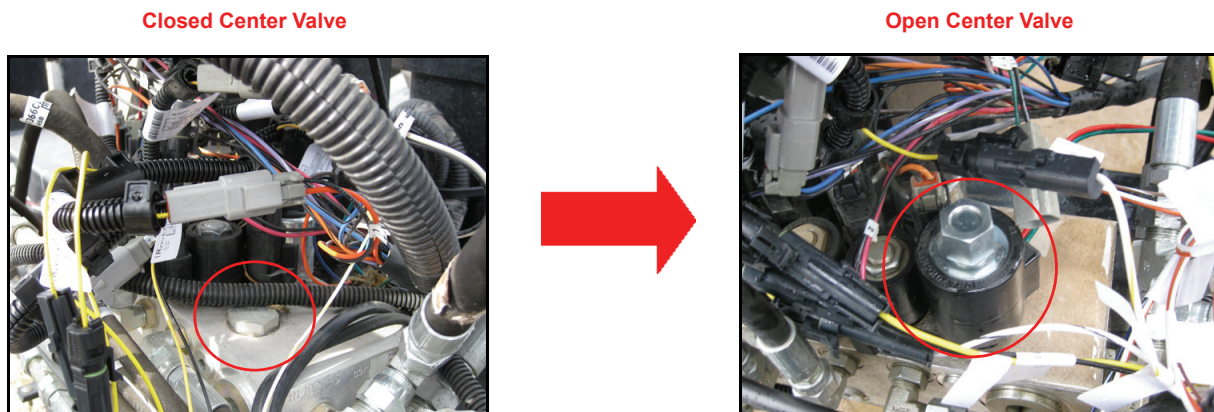

1. Locate the master open center coil port on the machine's hydraulic valve.
2. Remove the cavity plug installed in the master open center coil port.
3. Install the master open center coil in the machine's hydraulic valve.

## Install Fittings on the AutoBoom Valve

Before mounting the AutoBoom valve on the machine, install the proper fittings on the valve. This prepares the valve for installation and simplifies the hose connection process later in the procedure. Refer to the following figure and table to install the fittings in the appropriate ports of the AutoBoom valve.

Fitting	Part Number	Port
Fitting - 9/16" JIC (M) to 9/16" SAE O-Ring (M) Straight Adapter	333-0012-045	LC, RC LV, RV
Fitting - 3/4" SAE O-Ring (M) to 3/4" JIC (M) Straight Adapter	333-0012-093	P, T, EF
Fitting - 9/16" JIC M/F 90° Swivel Elbow	333-0012-042	LC, RC



## Mount the AutoBoom Valve

FIGURE 2. AutoBoom Valve Mounted on the Valve Mounting Plate

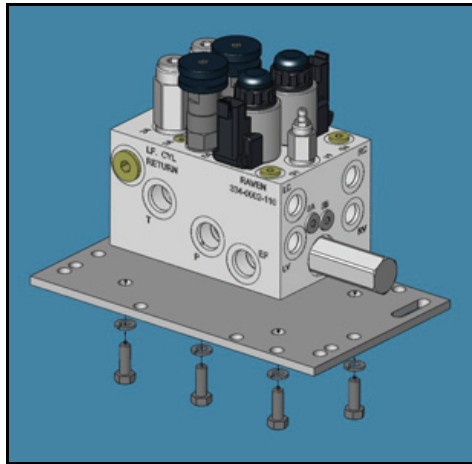

1. Secure the AutoBoom valve (P/N 063-0131-127) to the mounting plate (P/N 107-0171-619) using four 5/16" hex bolts (P/N 311-0052-104) and four 5/16" lock washers (P/N 313-1000-019).

FIGURE 3. AutoBoom Valve Mounted on the Machine

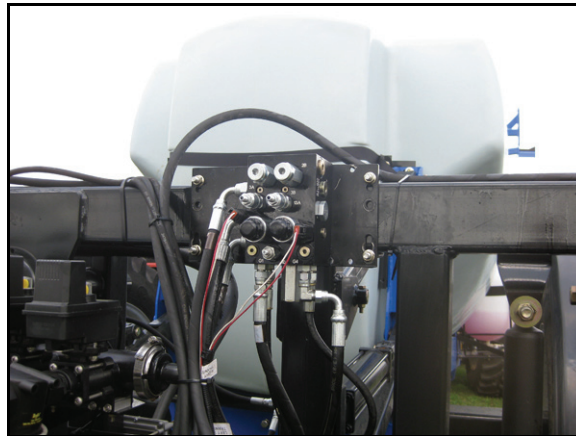

2. Mount the AutoBoom valve using two 4" W x 5" L x 3/8" thread U-bolts (P/N 107-0171-606) and four 3/8" zinc flanged lock nuts (P/N 312-1001-164).



## Install the Pressure and Tank Hoses



**! WARNING**

Hydraulics are under pressure. Care should always be taken with a system that has been pressurized. When disconnecting or purging the hydraulic hoses, be aware that the hydraulic fluid within the machine may be extremely hot and under high pressure.



**! CAUTION**

When installing AutoBoom hydraulics or performing diagnostics, maintenance, or routine service, ensure precautions are taken to prevent any foreign material or contaminants from being introduced into the machine's hydraulic system.

Objects or materials that are able to bypass the machine's hydraulic filtration system will reduce performance and possibly damage the AutoBoom hydraulic valve.

FIGURE 4. Extension Hose Installed on Machine's Pressure Hose

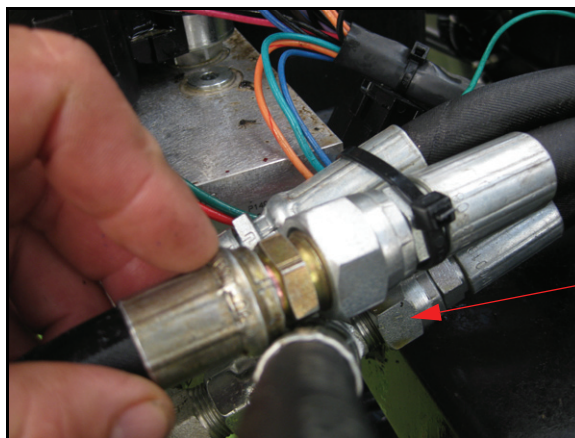

Tank Tee Fitting

1. Disconnect the pressure hose from the machine's stack valve.
2. Install the straight end of the supplied hydraulic hose (P/N 214-1000-592) to the machine's pressure hose.

**FIGURE 5. Pressure and Tank Lines Installed**



3. Connect the 90° end of the installed hydraulic hose to Port P on the AutoBoom valve.
4. Install the straight end of the supplied hydraulic hose (P/N 214-1000-432) to Port P on the machine's hydraulic valve.
5. Connect the 90° end of the installed hydraulic hose to Port EF on the AutoBoom valve.
6. Disconnect the tank hose from the machine's stack valve.
7. Install a 3/4" JIC M/M/F swivel run tee adapter fitting (P/N 333-0012-039) on Port T of the machine's stack valve.
8. Connect the machine's tank hose to the opposite end of the installed tee fitting.
9. Install the straight end of the supplied hydraulic hose (P/N 214-1000-432) on the installed tee fitting.
10. Connect the 90° end of the hydraulic hose to Port T on the AutoBoom valve.

## Install the Left and Right Cylinder Hoses

**FIGURE 6. Cylinder Hoses Installed on the AutoBoom Valve**

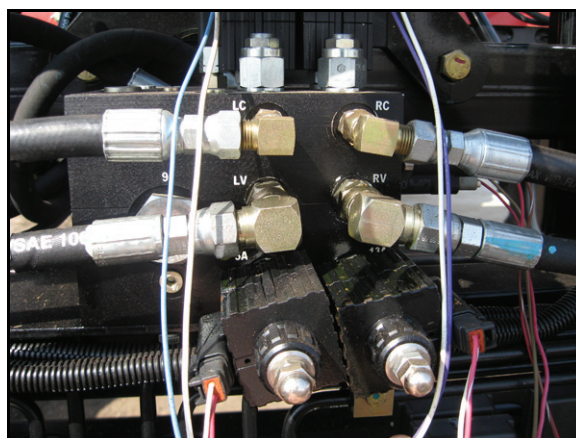

1. Disconnect the machine's raise hoses from the rod-end of the tilt cylinders and route them back to the AutoBoom valve.
2. Connect the machine's right raise hose to Port RV on the AutoBoom valve.
3. Connect the machine's left raise hose to Port LV on the AutoBoom valve.

**FIGURE 7. Hydraulic Hoses Installed on Machine's Cylinders**

4. Install the straight end of the supplied hydraulic hose (P/N 214-1000-295) on the rod-end of the machine's right tilt cylinder.
5. Connect the 90° end of the hydraulic hose to the installed adapter fittings in Port RC on the AutoBoom valve.
6. Install the straight end of the supplied hydraulic hose (P/N 214-1000-291) on the rod-end of the machine's left tilt cylinder.
7. Connect the 90° end of the hydraulic hose to the installed adapter fittings in Port LC on the AutoBoom valve.



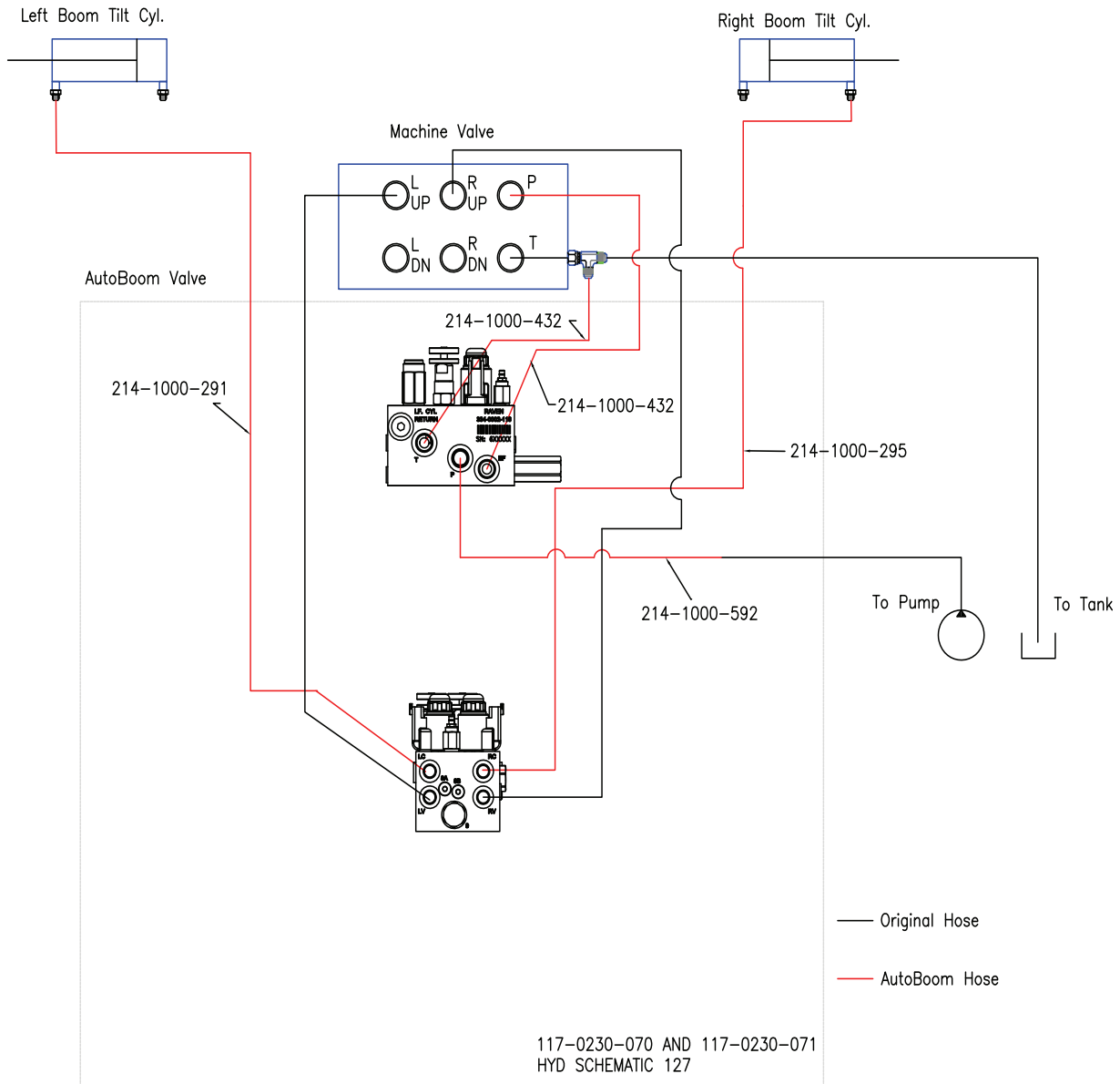

# PowerGlide Hydraulic Schematic



## Install the Gauge Wheels

### Mount the Gauge Wheels

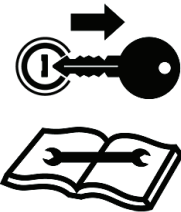
Wheel mounting locations may be influenced by the boom configuration. Determine the appropriate location for mounting wheels on the boom, ensuring they will not interfere with or be damaged by folding or unfolding the booms. The wheel should be mounted outside of the boom fold, but inside of the boom breakaway.

	<div style="background-color: #e67e22; color: white; padding: 5px; text-align: center;">  <b>WARNING</b> </div> <p>The machine must remain stationary and switched off, with the booms unfolded and supported, during installation or maintenance.</p>
---	---

**Note:** *The appearance of the wheel axles will vary, depending on the wheel axle kit that was ordered with the AutoBoom system.*

**FIGURE 8. Gauge Wheel Installed**



1. Remove the lug nuts from the right wheel axle.
2. Place the wheel (P/N 322-0131-008) on the right wheel axle.
3. Reinstall the lug nuts on the wheel axle to secure the wheel.
4. Attach the right wheel mounting bracket (P/N 116-0159-658) to the back of the right boom by installing four 2-1/16" W x 3" L x 3/8" thread U-bolts (P/N 107-0171-609) through the back of the mounting bracket and securing them with eight 3/8" zinc flanged lock nuts (P/N 312-1001-164).
5. Insert the left wheel axle into the left wheel mounting bracket, positioning it so that the bottom of the wheel touches the ground (or nearly so) and the wheel faces away from the machine.
6. Secure the gauge wheel assembly in the wheel mounting bracket by installing two 1/2"-13 x 1-1/2" SS hex bolts (P/N 311-0058-186) and two 1/2" zinc hex nuts (P/N 312-1001-043).
7. Repeat the steps above to install the right wheel.

## Install the PowerGlide Wiring

### Wiring Connections

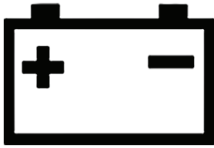
	<p style="text-align: center;"><b>⚠ CAUTION</b></p> <p>Always connect the power cable as the last step in the wiring process and verify that the power leads are connected with the correct polarity. Reversing power leads can cause severe damage to the equipment.</p>
---	---

For wiring connections made outside of the cab, apply dielectric silicone grease (P/N 222-0000-006) generously on both the male and female ends of the connectors. Application of the grease will prevent corrosion to the pins and wires.

### Connect the Harness Cable to the Boom Function Controls

1. On the harness cable (P/N 115-0230-003), locate the Left Solenoid connector and connect it to Port 4A on the AutoBoom valve.
2. Connect the Right Solenoid connector to Port 4B on the AutoBoom valve.

**FIGURE 9. Machine's Left and Right Tilt Boom Function Coils**

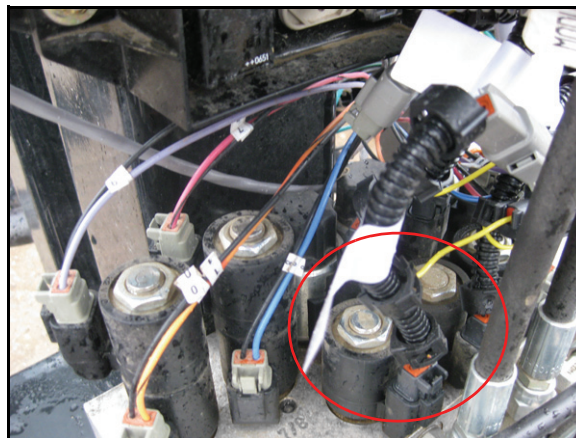

3. Locate the machine's boom function coils near the machine's hydraulic valve.
4. Disconnect the connector from the left tilt up coil.
5. Install a boom sense adapter cable (P/N 115-0171-546) between the coil and the machine's coil connector.
6. Connect the boom sense adapter cables between the left tilt down, right tilt up, and right tilt down coils and the coil connectors.
7. On the harness cable, locate the Left Solenoid Sense connectors. Isolate the connector labeled Up and connect it to the left tilt up coil via the installed boom sense adapter cable.
8. Connect the down Left Solenoid Sense connector to the left tilt down coil via the installed boom sense adapter cable.
9. Connect the Right Solenoid Sense connectors to the machine's right tilt up and right tilt down coils via the installed boom sense adapter cables.



## Connect the Harness Cable

1. Route the harness cable (P/N 115-0230-003) toward the machine's cab.
2. Connect the harness cable to the controller cable (P/N 115-0230-002). Tighten the connector cap to secure.

**Note:** *Be sure to allow enough slack in the harness cable to allow for boom racking. If the harness cable is not long enough, it may be necessary to connect the 12' extension cable (P/N 115-0230-008) between the harness and controller cables.*

## Connect the Controller

FIGURE 10. Controller Connectors



1. Route the controller cable (P/N 115-0230-002) into the right side of the machine's cab.
2. Locate the two controller connectors. Connect them to the AutoBoom controller (P/N 063-0130-011).

**Note:** *The AutoBoom controller should be mounted in the machine's cab so that the machine operator has easy access to it.*

## Connect the Power Leads

1. Locate the power cable that has the red and white power leads at one end.
2. Disconnect the machine's connectors from the battery terminals.
3. Install the red power lead on the positive battery terminal and reinstall the machine's battery connector.
4. Install the white power lead on the negative battery terminal and reinstall the machine's battery connector.

# PowerGlide Wiring Schematic

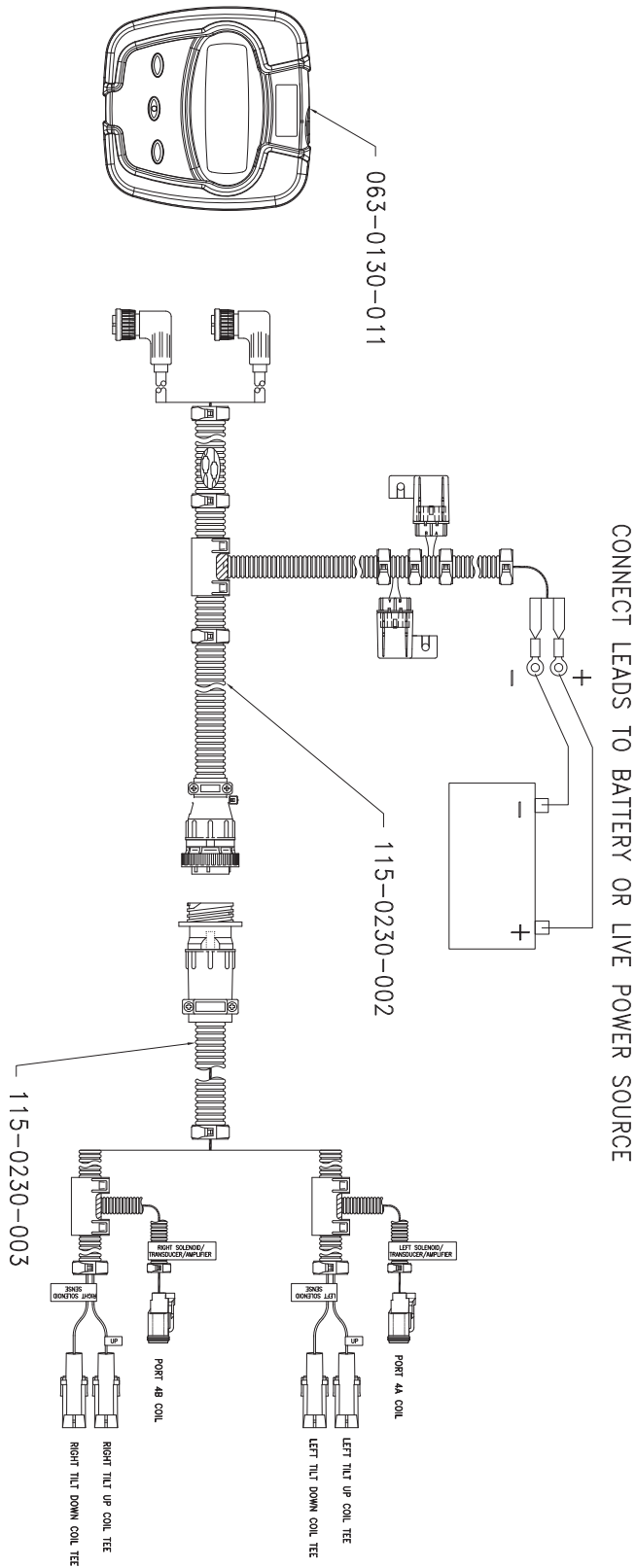





**CHAPTER****4*****PowerGlide Plus******PowerGlide Plus Kit Contents***

This section contains a list of the components that are included in the PowerGlide Plus AutoBoom kit. Before beginning the AutoBoom installation, compare the items in the AutoBoom kit with the components on this list. If you have questions about the kit, contact your Raven dealer.

**TABLE 1. PowerGlide Plus Installation Kit (P/N 117-0231-071)**

<b>Picture</b>	<b>Item Description</b>	<b>Part Number</b>	<b>Qty.</b>
Not Pictured	Manual - 2007 Flexi-Coil 68 Series & CaseIH SRX Series 120' - 134' Boom	016-0230-071	1
	Valve - PowerGlide Plus AutoBoom	016-0131-126	1
	Plate - Hydraulic Block Mounting	107-0171-802	1
	Cable - Boom Sense Adapter	115-0171-546	4
	Cable - 12' PowerGlide Plus/UltraGlide Extension	115-0230-008	1
	U-Bolt - 4" W x 5" L x 3/8" Thread	107-0171-606	2

**TABLE 1. PowerGlide Plus Installation Kit (P/N 117-0231-071)**

Picture	Item Description	Part Number	Qty.
	Bolt - 5/16"-18 x 7/8" Hex	311-0052-104	4
	Gold - 3/8"-16 x 1-1/4" Hex	311-0054-106	3
	Nut - 3/8"-16 Zinc Flanged Lock	312-1001-164	7
	Washer - 5/16" Zinc Plated Lock	313-1000-019	4

**TABLE 2. Hydraulic Kit (P/N 117-0134-071)**

Picture	Item Description	Part Number	Qty.
	Fitting - 3/4" JIC M/M/F Swivel Run Tee Adapter	333-0012-039	1
	Fitting - 9/16" JIC M/F 90° Swivel Elbow	333-0012-042	2
	Fitting - 9/16" JIC (M) to 9/16" SAE O-Ring (M) Straight Adapter	333-0012-045	4
	Fitting - 3/4" SAE O-Ring (M) to 3/4" JIC (M) Straight Adapter	333-0012-093	3
	Hydraulic Hose - 9/16" JIC (F) to 9/16" JIC 90° (F) - 132"	214-1000-291	1
	Hydraulic Hose - 9/16" JIC (F) to 9/16" JIC 90° (F) - 114"	214-1000-295	1

TABLE 2. Hydraulic Kit (P/N 117-0134-071)













Picture	Item Description	Part Number	Qty.
	Hydraulic Hose - 3/4" JIC (F) to 3/4" JIC 90° (F) - 38"	214-1000-432	2
	Hydraulic Hose - 3/4" JIC (M) to 3/4" JIC (F) - 36"	214-1000-592	1



TABLE 3. PowerGlide Plus Wheel Kit (P/N 117-0133-071)

Picture	Item Description	Part Number	Qty.
	Axle Assembly - Right Cushioned Offset AutoBoom	063-0131-589	1
	Axle Assembly - Left Cushioned Offset AutoBoom	063-0131-591	1
	Bracket - 2007 Flexi-Coil 120', 134' Weldment	116-0159-658	2
	Wheel	322-0131-008	2
	U-Bolt - 2-1/16" W x 3" L x 3/8" Thread	107-0171-609	8
	Bolt - 1/2"-13 x 1-1/2" SS Hex	311-0058-186	4
	Nut - 1/2"-13 Zinc Hex	312-1001-043	4
	Nut - 3/8"-16 Zinc Flanged Lock	312-1001-164	16

**TABLE 4. Gen I PowerGlide Plus Wiring Kit (P/N 117-0137-023)**

Picture	Item Description	Part Number	Qty.
Not Pictured	Manual - AutoBoom Calibration & Operation	016-0130-062	1
	Node - PowerGlide Plus AutoBoom	063-0130-010	1
	Cable - Harness	115-0230-045	1
	Cable - Power/CAN	115-0230-007	1

**TABLE 5. Gen II PowerGlide Plus Wiring Kit (P/N 117-5130-001)**

Picture	Item Description	Part Number	Qty.
Not Pictured	Manual - AutoBoom Calibration & Operation	016-0130-062	1
	Node - PowerGlide Plus AutoBoom	063-0130-010	1
	Cable - PowerGlide Plus/UltraGlide with CAN/Power Tee AutoBoom	115-0230-085	1

## Install the PowerGlide Plus Hydraulic System

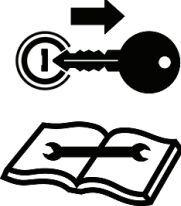
	<p><b>WARNING</b></p> <p>The machine must remain stationary and switched off, with the booms unfolded and supported, during installation or maintenance.</p>
---	--

	<p><b>CAUTION</b></p> <p>When installing AutoBoom hydraulics or performing diagnostics, maintenance, or routine service, ensure precautions are taken to prevent any foreign material from being introduced into the machine's hydraulic system.</p> <p>Objects or materials that are able to bypass the machine's hydraulic filtration system will reduce performance and possibly damage the AutoBoom hydraulic valve.</p>
---	--

	<p><b>NOTICE</b></p> <p>The appearance of the AutoBoom hydraulic valve may vary slightly from the images contained in this manual. However, the fittings, hose connections, and cable connections remain the same.</p>
---	--

### Convert the Sprayer's Hydraulic Valve to Open Center (If Applicable)

By factory default, the machine's main hydraulic valve is configured as an "open center" hydraulic system. However, if the hydraulic valve has been converted to a "closed center" system, it will have to be changed back to the "open center" configuration. Complete the following steps to convert the machine's hydraulic system from a "closed center" to "open center" system.

**Note:** *The machine came equipped from the factory with a master open center coil that is necessary to convert the hydraulic valve. If the master open center coil has been misplaced, a replacement must be obtained from the dealer from whom the machine was purchased.*

FIGURE 1. Converted Hydraulic Valve - Closed Center to Open Center

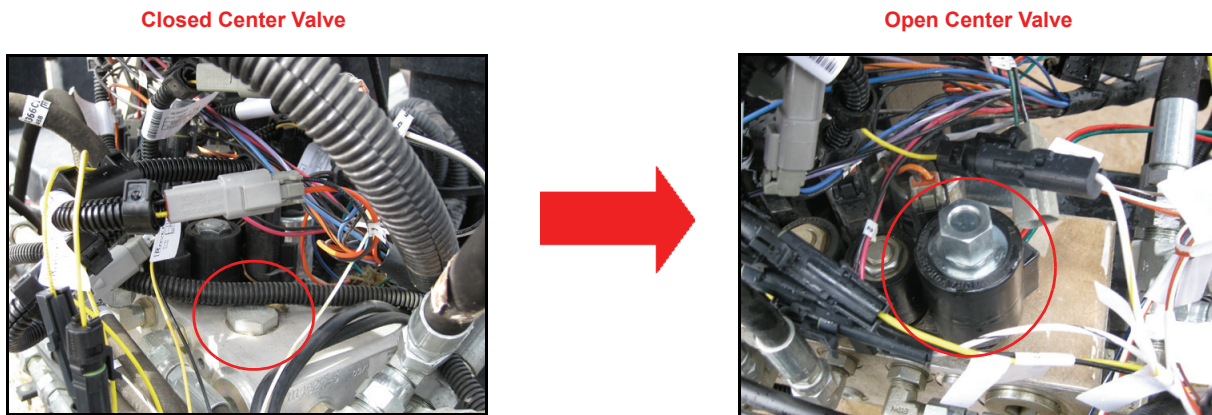

1. Locate the master open center coil port on the machine's hydraulic valve.
2. Remove the cavity plug installed in the master open center coil port.
3. Install the master open center coil in the machine's hydraulic valve.

## Remove the Orifice Fittings

Before populating the hydraulic fittings on the AutoBoom valve, it is necessary to remove orifice fittings from the valve in the PowerGlide Plus system. Failure to remove these fittings from the valve will restrict the down speed of the booms when the system is enabled.

FIGURE 2. Port 3A and 3B Location

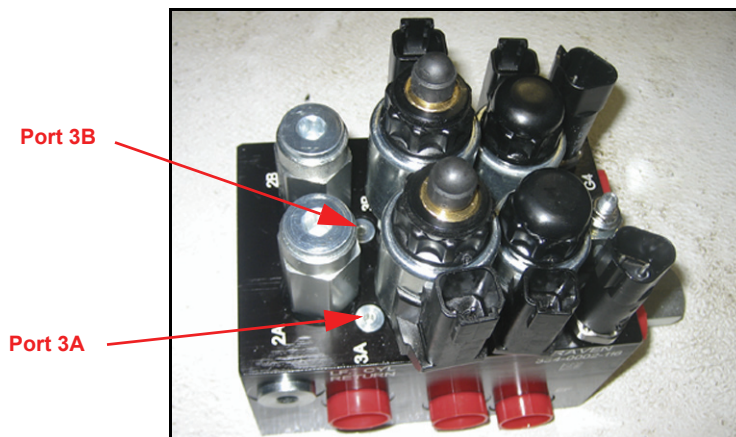

1. Locate Ports 3A and 3B on the AutoBoom valve.

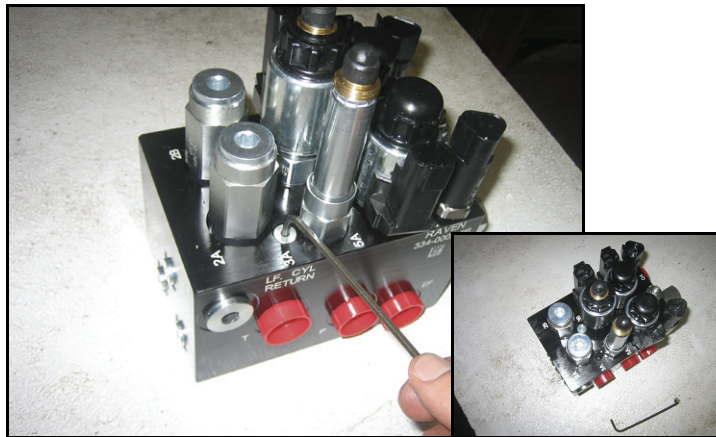

**FIGURE 3. Coil Removed from the AutoBoom Valve**



2. Remove the coils from the solenoids near Ports 3A and 3B to gain easy access to those ports.

**FIGURE 4. Port Plugs Removed from the AutoBoom Valve**



3. Use an Allen wrench to remove the plugs from Ports 3A and 3B.

**FIGURE 5. Orifice Fitting Removed from the AutoBoom Valve**

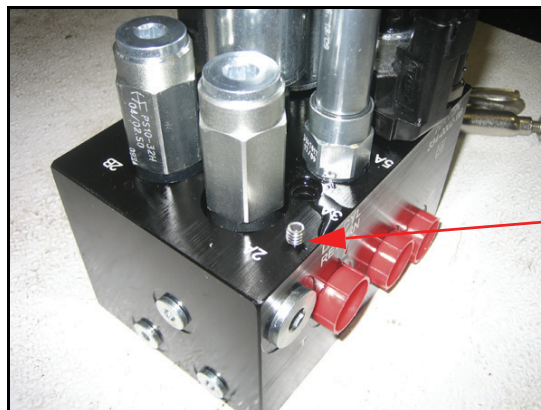

Orifice Fitting  
Removed - Keep for  
Future Use

4. Remove the orifice fittings from Ports 3A and 3B.

**Important:** Tip the AutoBoom valve on its side and use the Allen wrench to remove the orifice from the cavity, taking care not to let the fitting fall into the valve.

**FIGURE 6. Port Plug Reinstalled on the AutoBoom Valve**



5. Use the Allen wrench to reinstall the port plugs on Ports 3A and 3B of the AutoBoom valve.

**FIGURE 7. Coil Reinstalled on the AutoBoom Valve**



6. Reinstall the coils on the solenoids of the AutoBoom valve.

## Install Fittings on the AutoBoom Valve

Before mounting the AutoBoom valve on the machine, install the proper fittings on the valve. This prepares the valve for installation and simplifies the hose connection process later in the procedure. Refer to the following figure and table to install the fittings in the appropriate ports of the AutoBoom valve.

Fitting	Part Number	Port
Fitting - 9/16" JIC (M) to 9/16" SAE O-Ring (M) Straight Adapter	333-0012-045	LC, RC LV, RV
Fitting - 3/4" SAE O-Ring (M) to 3/4" JIC (M) Straight Adapter	333-0012-093	P, T, EF
Fitting - 9/16" JIC M/F 90° Swivel Elbow	333-0012-042	LC, RC



## Mount the AutoBoom Valve

FIGURE 8. AutoBoom Valve Mounted on the Valve Mounting Plate

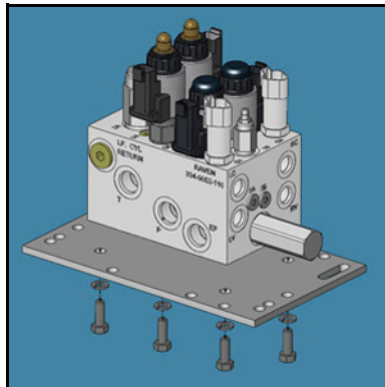

1. Secure the AutoBoom valve (P/N 063-0131-126) to the mounting plate (P/N 107-0171-802) using four 5/16" hex bolts (P/N 311-0052-104) and four 5/16" lock washers (P/N 313-1000-019).

FIGURE 9. AutoBoom Valve Mounted on the Machine

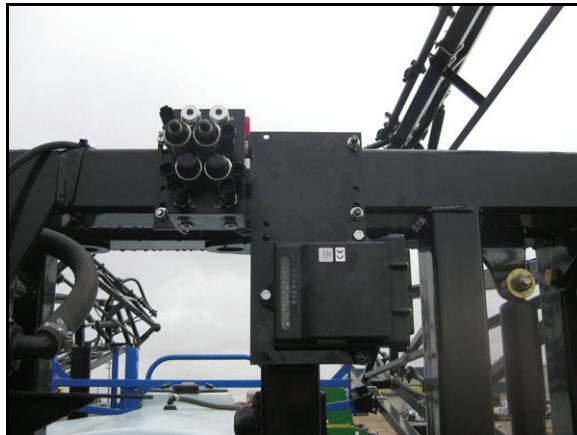

2. Mount the AutoBoom valve using two 4" W x 5" L x 3/8" thread U-bolts (P/N 107-0171-606) and four 3/8" zinc flanged lock nuts (P/N 312-1001-164).

## Install the Pressure and Tank Hoses

	<p><b>WARNING</b></p> <p>Hydraulics are under pressure. Care should always be taken with a system that has been pressurized. When disconnecting or purging the hydraulic hoses, be aware that the hydraulic fluid within the machine may be extremely hot and under high pressure.</p>
---	--

	<p><b>CAUTION</b></p> <p>When installing AutoBoom hydraulics or performing diagnostics, maintenance, or routine service, ensure precautions are taken to prevent any foreign material or contaminants from being introduced into the machine's hydraulic system.</p> <p>Objects or materials that are able to bypass the machine's hydraulic filtration system will reduce performance and possibly damage the AutoBoom hydraulic valve.</p>
---	--

FIGURE 10. Extension Hose Installed on Machine's Pressure Hose



1. Disconnect the pressure hose from the machine's stack valve.
2. Install the straight end of the supplied hydraulic hose (P/N 214-1000-592) to the machine's pressure hose.

FIGURE 11. Pressure and Tank Lines Installed

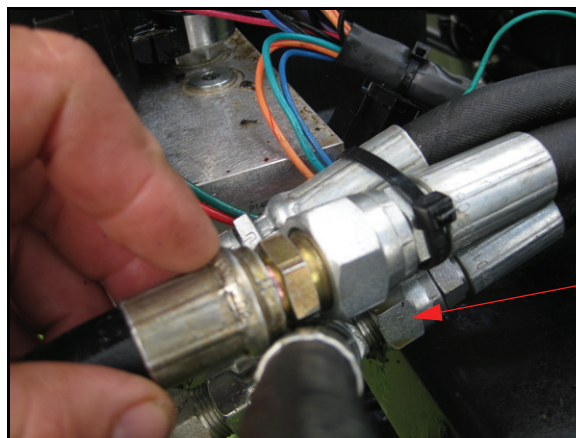

3. Connect the 90° end of the installed hydraulic hose to Port P on the AutoBoom valve.
4. Install the straight end of the supplied hydraulic hose (P/N 214-1000-432) to Port P on the machine's hydraulic valve.
5. Connect the 90° end of the installed hydraulic hose to Port EF on the AutoBoom valve.
6. Disconnect the tank hose from the machine's stack valve.
7. Install a 3/4" JIC M/M/F swivel run tee adapter fitting (P/N 333-0012-039) on Port T of the machine's stack valve.
8. Connect the machine's tank hose to the opposite end of the installed tee fitting.
9. Install the straight end of the supplied hydraulic hose (P/N 214-1000-432) on the installed tee fitting.
10. Connect the 90° end of the hydraulic hose to Port T on the AutoBoom valve.

## Install the Left and Right Cylinder Hoses

FIGURE 12. Cylinder Hoses Installed on the AutoBoom Valve

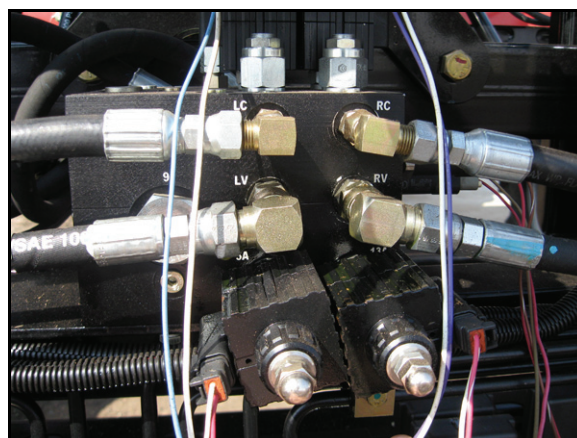

1. Disconnect the machine's raise hoses from the rod-end of the tilt cylinders and route them back to the AutoBoom valve.
2. Connect the machine's right raise hose to Port RV on the AutoBoom valve.
3. Connect the machine's left raise hose to Port LV on the AutoBoom valve.

FIGURE 13. Hydraulic Hoses Installed on Machine's Cylinders

---



4. Install the straight end of the supplied hydraulic hose (P/N 214-1000-295) on the rod-end of the machine's right tilt cylinder.
5. Connect the 90° end of the hydraulic hose to the installed adapter fittings in Port RC on the AutoBoom valve.
6. Install the straight end of the supplied hydraulic hose (P/N 214-1000-291) on the rod-end of the machine's left tilt cylinder.
7. Connect the 90° end of the hydraulic hose to the installed adapter fittings in Port LC on the AutoBoom valve.

# PowerGlide Plus Hydraulic Schematic

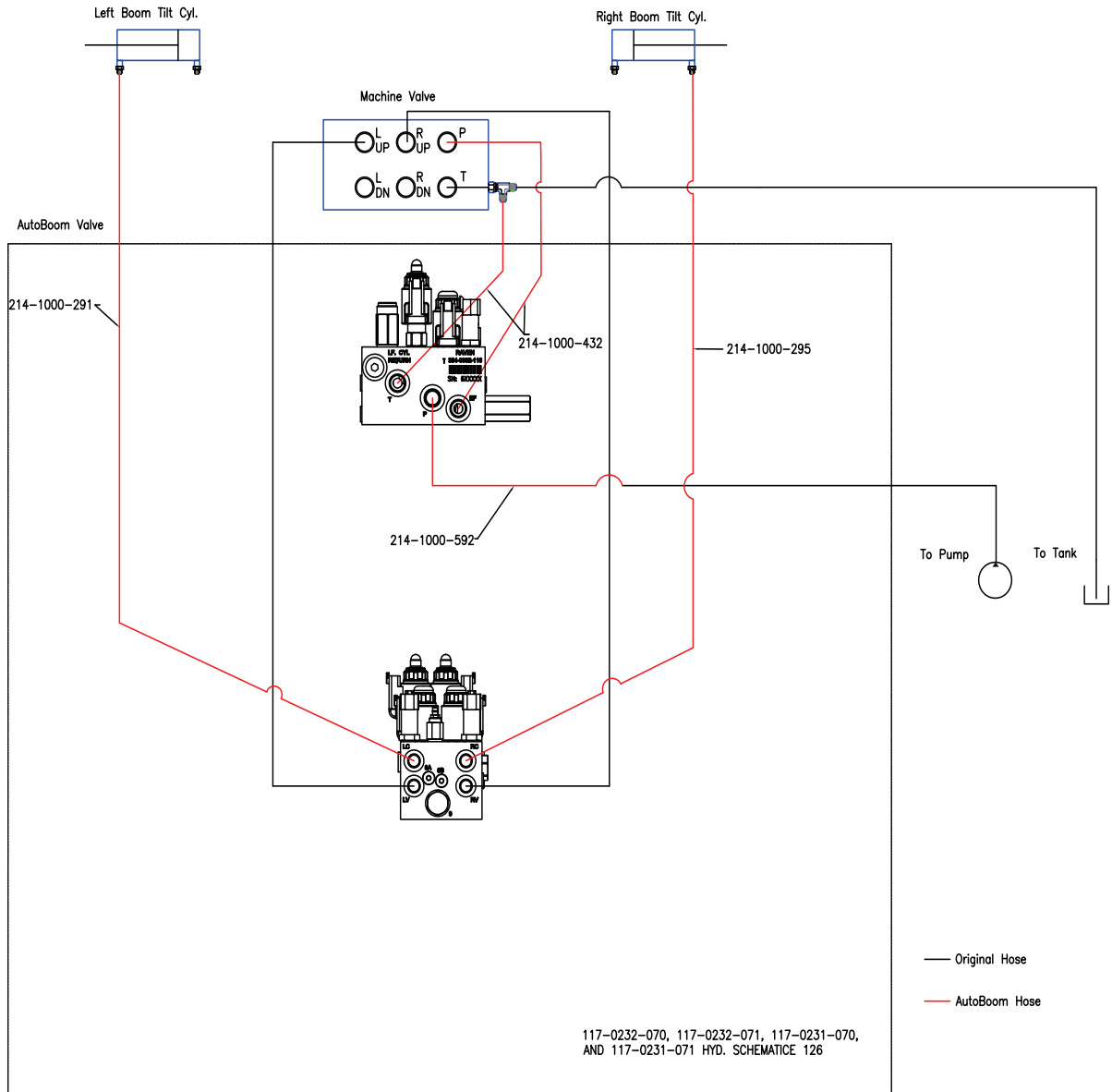

## Install the Gauge Wheels

### Gauge Wheel Mounting Locations

Wheel mounting locations may be influenced by the boom configuration. Determine the appropriate location for mounting the wheels on the boom, ensuring the wheels will not interfere with or be damaged while folding or unfolding the booms.

### Mount the Gauge Wheels

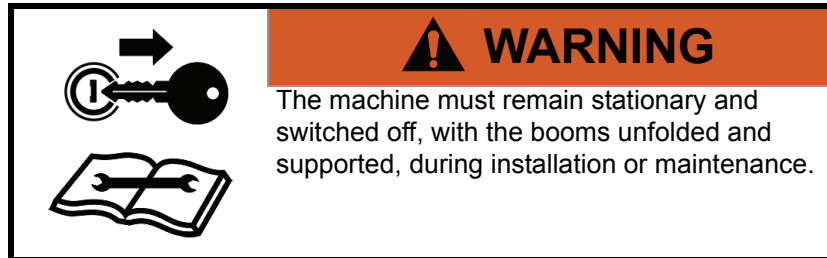

**Note:** The appearance of the wheel axles may vary.

FIGURE 14. Gauge Wheel Installed



1. Remove the lug nuts from the right wheel axle (P/N 063-0131-589).
2. Place the wheel (P/N 322-0131-008) on the right wheel axle.
3. Reinstall the lug nuts on the wheel axle to secure the wheel.
4. Attach the right wheel mounting bracket (P/N 116-0159-658) to the back of the right boom by installing four 2-1/16" W x 3" L x 3/8" thread U-bolts (P/N 107-0171-609) through the back of the mounting bracket and securing them with eight 3/8" zinc flanged lock nuts (P/N 312-1001-164).
5. Insert the left wheel axle into the left wheel mounting bracket, positioning it so that the bottom of the wheel touches the ground (or nearly so) and the wheel faces away from the machine.
6. Secure the gauge wheel assembly in the wheel mounting bracket by installing two 1/2"-13 x 1-1/2" SS hex bolts (P/N 311-0058-186) and two 1/2" zinc hex nuts (P/N 312-1001-043).
7. Repeat the steps above to install the left wheel.



## Install the PowerGlide Plus Wiring

### Wiring Connections

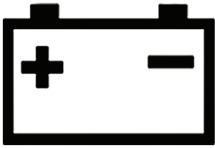
	<p style="text-align: center;"><b>⚠ CAUTION</b></p> <p>Always connect the power cable as the last step in the wiring process and verify that the power leads are connected with the correct polarity. Reversing power leads can cause severe damage to the equipment.</p>
---	---

For wiring connections made outside of the cab, apply dielectric silicone grease (P/N 222-0000-006) generously on both the male and female ends of the connectors. Application of the grease will prevent corrosion to the pins and wires.

### Install the AutoBoom Node

FIGURE 15. PowerGlide Plus AutoBoom Node Installed

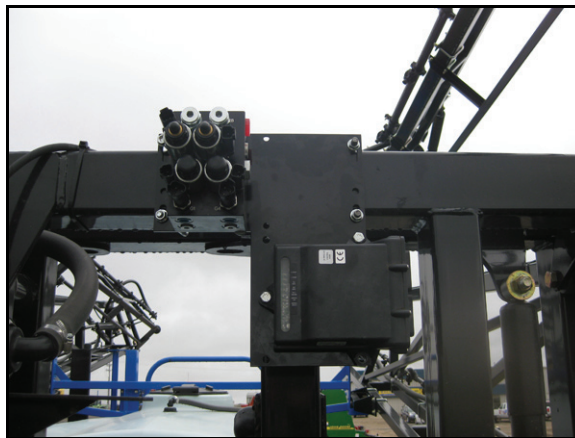

1. Mount the AutoBoom node (P/N 063-0130-010) to the AutoBoom valve hydraulic mounting plate (P/N 107-0171-802) using three 3/8"-16 zinc hex bolts (P/N 311-0054-106) and three 3/8"-16 zinc flanged lock nuts (P/N 312-1001-164).

**Note:** Make sure that the node is positioned so that the cable connectors face down or to the side.

2. Insert the large, rectangular node connectors on the harness cable (P/N 115-0230-045 or 115-0230-085) into the correct ports of the AutoBoom valve.
3. Tighten the bolts on the node connectors to secure the connections.

### Connect the Harness Cable to the Boom Function Controls

1. Locate the Left Press and Right Press connectors on the harness cable (P/N 115-0230-045 or 115-0230-085).
2. Route the connectors to the AutoBoom valve (P/N 063-0131-126).
3. Connect the Left Press connector to Port G1 on the AutoBoom valve.

4. Connect the Right Press connector to Port G4 on the AutoBoom valve.
5. Locate the Left Solenoid and Right Solenoid connectors on the harness cable.
6. Connect the Left Solenoid connector to Port 4A on the AutoBoom valve.
7. Connect the Right Solenoid connector to Port 4B on the AutoBoom valve.
8. Locate the Left Prop and Right Prop connectors on the harness cable.
9. Connect the Left Prop connector to Port 5A on the AutoBoom valve.
10. Connect the Right Prop connector to Port 13A on the AutoBoom valve.

**FIGURE 16. Machine's Left and Right Tilt Boom Function Coils**

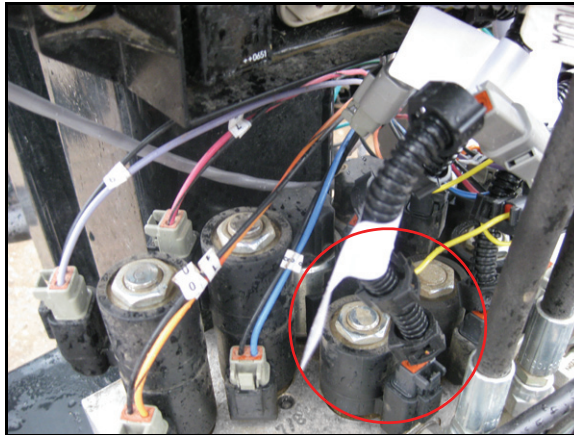

11. Locate the machine's boom function coils near the machine's hydraulic valve.
12. Disconnect the connector from the left tilt up coil.
13. Install a boom sense adapter cable (P/N 115-0171-546) between the coil and the machine's coil connector.
14. Connect the boom sense adapter cables between the left tilt down, right tilt up, and right tilt down coils and the coil connectors.
15. On the harness cable, locate the Left Solenoid Sense connectors. Isolate the connector labeled Up and connect it to the left tilt up coil via the installed boom sense adapter cable.
16. Connect the down Left Solenoid Sense connector to the left tilt down coil via the installed boom sense adapter cable.
17. Connect the Right Solenoid Sense connectors to the machine's right tilt up and right tilt down coils via the installed boom sense adapter cables.

### **Connect the Harness Cable to the Implement Extension Tee - Gen II Cable Only**

1. Route the harness cable (P/N 115-0230-085) toward the implement extension tee cable.
2. Connect the harness cable to the To Node connector.
3. Remove the terminator from the machine's chassis harness or the standalone console harness.
4. Install the terminator on the remaining open end of the implement extension tee cable.
5. Refer to the wiring schematic (beginning on page 36) appropriate for the machine's configuration to route the implement extension tee cable.
6. Connect the implement extension tee cable to the location determined in the step above.



---

## Connect the Harness Cable to the Controller Cable - Gen I Cable Only

1. Route the harness cable (P/N 115-0230-045) toward the machine's cab.
2. Connect the harness cable to the controller cable (P/N 115-0230-007).
3. Tighten the connector screw cap to secure the connection.

## Connect the Controller (If Applicable) - Gen I Cable Only

1. Route the controller cable (P/N 115-0230-007) into the right side of the machine's cab.
2. Locate the two controller connectors and connect them to the AutoBoom controller (P/N 063-0130-021).

**Note:** *The AutoBoom controller should be mounted in the machine's cab so that the machine's operator has easy access to it.*

## Connect the Field Computer (If Applicable)

Refer to the Installation & Operation Manual and the appropriate wiring schematic beginning on page 36 for installation and wiring instructions for your specific field computer.

## Connect the Power Leads

1. Locate the power cable that has the red and white power leads at one end.
2. Disconnect the machine's connectors from the battery terminals.
3. Install the red power lead on the positive battery terminal and reinstall the machine's battery connector.
4. Install the white power lead on the negative battery terminal and reinstall the machine's battery connector.









**CHAPTER****5*****UltraGlide******UltraGlide Kit Contents***

This section contains a list of the components that are included in the UltraGlide AutoBoom kit. Before beginning the AutoBoom installation, compare the items in the AutoBoom kit with the components on this list. If you have questions about the kit, contact your Raven dealer.

**TABLE 1. UltraGlide Installation Kit (P/N 117-0232-071)**

<b>Picture</b>	<b>Item Description</b>	<b>Part Number</b>	<b>Qty.</b>
Not Pictured	Manual - 2007 Flexi-Coil 68 Series & CaseIH SRX Series 120' - 134' Boom	016-0230-071	1
	Valve - UltraGlide AutoBoom	063-0131-126	1
	Plate - Hydraulic Block Mounting	107-0171-802	1
	Sensor - Right Ultrasonic	063-0130-012	1
	Sensor - Left Ultrasonic	063-0130-014	1
	Sensor - Center Ultrasonic	063-0130-018	1

**TABLE 1. UltraGlide Installation Kit (P/N 117-0232-071)**



Picture	Item Description	Part Number	Qty.
	Weldment - Ultrasonic Sensor Boom Mount	116-0159-684	1
	Cable - Boom Sense Adapter	115-0171-546	5
	Cable - Center Rack Control Adapter	115-0230-039	2
	Cable - 12' PowerGlide Plus/UltraGlide Extension	115-0230-008	1
	U-Bolt - 4" W x 5" L x 3/8" Thread	107-0171-606	2
	U-Bolt - 3-1/16" W x 4" L x 3/8" Thread	107-0171-608	2
	U-Bolt - 2-9/16" W x 3" L x 3/8" Thread	107-0171-609	4
	Bolt - 5/16"-24 x 1" Grade 8 Hex	311-0052-104	4
	Bolt - 3/8"-16 UNC x 1-1/4" Hex	311-0054-106	7
	Nut - 3/8"-16 Zinc Flanged Lock	312-1001-164	23
	Washer - 5/16" Zinc Plated Lock	313-1000-019	4

TABLE 2. Hydraulic Kit (P/N 117-0134-071)



Picture	Item Description	Part Number	Qty.
	Fitting - 3/4" JIC M/M/F Swivel Run Tee Adapter	333-0012-039	1
	Fitting - 9/16" JIC M/F 90° Swivel Elbow	333-0012-042	2
	Fitting - 9/16" JIC (M) to 9/16" SAE O-Ring (M) Straight Adapter	333-0012-045	4
	Fitting - 3/4" SAE O-Ring (M) to 3/4" JIC (M) Straight Adapter	333-0012-093	3
	Hydraulic Hose - 9/16" JIC (F) to 9/16" JIC 90° (F) - 132"	214-1000-291	1
	Hydraulic Hose - 9/16" JIC (F) to 9/16" JIC 90° (F) - 114"	214-1000-295	1
	Hydraulic Hose - 3/4" JIC (F) to 3/4" JIC 90° (F) - 38"	214-1000-432	2
	Hydraulic Hose - 3/4" JIC (M) to 3/4" JIC (F) - 36"	214-1000-592	1

TABLE 3. UltraGlide Wiring Kit (P/N 117-0137-024)

Picture	Item Description	Part Number	Qty.
Not Pictured	CAN AutoBoom Calibration & Operation Manual	016-0130-062	1
	AutoBoom Node	063-0130-013	1



**TABLE 3. UltraGlide Wiring Kit (P/N 117-0137-024)**

Picture	Item Description	Part Number	Qty.
	Cable - Sensor	115-0171-527	2
	Cable - Harness	115-0230-045	1
	Cable - Power/CAN	115-0230-007	1

**TABLE 4. Gen I UltraGlide Wiring Kit (P/N 117-0137-024)**







Picture	Item Description	Part Number	Qty.
Not Pictured	Manual - AutoBoom Calibration & Operation	016-0130-062	1
	Node - UltraGlide AutoBoom	063-0130-013	1
	Cable - Sensor	115-0171-527	2
	Cable - Harness	115-0230-045	1
	Cable - Power/CAN Controller	115-0230-007	1

TABLE 5. Gen II UltraGlide Wiring Kit (P/N 117-5130-003)

Picture	Item Description	Part Number	Qty.
Not Pictured	Manual - AutoBoom Calibration & Operation	016-0130-062	1
	Node - UltraGlide AutoBoom	063-0130-013	1
	Cable - Sensor	115-0171-527	2
	Cable - PowerGlide Plus/UltraGlide with CAN/Power Tee AutoBoom	115-0230-085	1

## Install the UltraGlide Hydraulic System

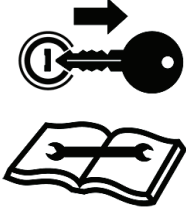

⚠ **WARNING**

The machine must remain stationary and switched off, with the booms unfolded and supported, during installation or maintenance.



⚠ **CAUTION**

When installing AutoBoom hydraulics or performing diagnostics, maintenance, or routine service, ensure precautions are taken to prevent any foreign material from being introduced into the machine's hydraulic system.

Objects or materials that are able to bypass the machine's hydraulic filtration system will reduce performance and possibly damage the AutoBoom hydraulic valve.

	<b>NOTICE</b>
	<p>The appearance of the AutoBoom hydraulic valve may vary slightly from the images contained in this manual. However, the fittings, hose connections, and cable connections remain the same.</p>

## Convert the Sprayer's Hydraulic Valve to Open Center (If Applicable)

By factory default, the machine's main hydraulic valve is configured as an "open center" hydraulic system. However, if the hydraulic valve has been converted to a "closed center" system, it will have to be changed back to the "open center" configuration. Complete the following steps to convert the machine's hydraulic system from a "closed center" to "open center" system.

**Note:** *The machine came equipped from the factory with a master open center coil that is necessary to convert the hydraulic valve. If the master open center coil has been misplaced, a replacement must be obtained from the dealer from whom the machine was purchased.*

**FIGURE 1. Converted Hydraulic Valve - Closed Center to Open Center**

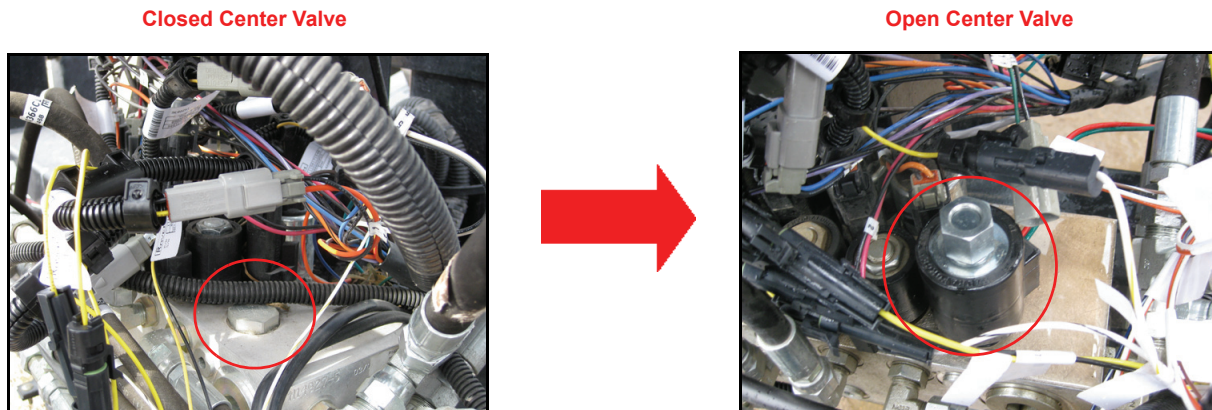

1. Locate the master open center coil port on the machine's hydraulic valve.
2. Remove the cavity plug installed in the master open center coil port.
3. Install the master open center coil in the machine's hydraulic valve.

## Install Fittings on the AutoBoom Valve

Before mounting the AutoBoom valve on the machine, install the proper fittings on the valve. This prepares the valve for installation and simplifies the hose connection process later in the procedure. Refer to the following figure and table to install the fittings in the appropriate ports of the AutoBoom valve.

Fitting	Part Number	Port
Fitting - 9/16" JIC (M) to 9/16" SAE O-Ring (M) Straight Adapter	333-0012-045	LC, RC LV, RV
Fitting - 3/4" SAE O-Ring (M) to 3/4" JIC (M) Straight Adapter	333-0012-093	P, T, EF
Fitting - 9/16" JIC M/F 90° Swivel Elbow	333-0012-042	LC, RC

## Mount the AutoBoom Valve

**FIGURE 2. AutoBoom Valve Mounted on the Valve Mounting Plate**

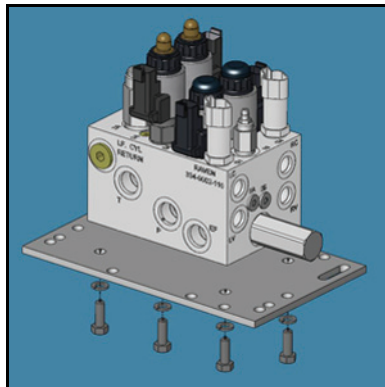

1. Secure the AutoBoom valve (P/N 063-0131-126) to the mounting plate (P/N 107-0171-802) using four 5/16" hex bolts (P/N 311-0052-104) and four 5/16" lock washers (P/N 313-1000-019).

**FIGURE 3. AutoBoom Valve Mounted on the Machine**

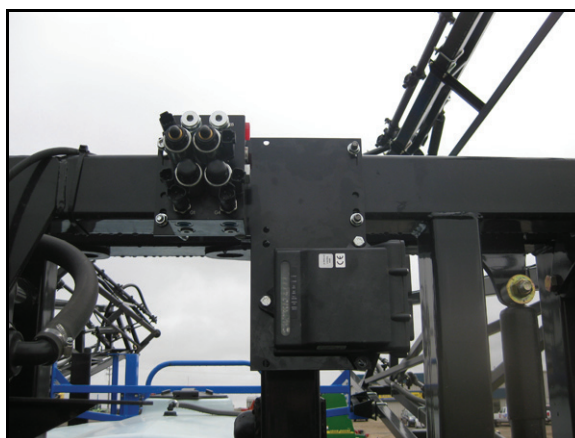

2. Mount the AutoBoom valve using two 4" W x 5" L x 3/8" thread U-bolts (P/N 107-0171-606) and four 3/8" zinc flanged lock nuts (P/N 312-1001-164).

## Install the Pressure and Tank Hoses

	<p><b>WARNING</b></p> <p>Hydraulics are under pressure. Care should always be taken with a system that has been pressurized. When disconnecting or purging the hydraulic hoses, be aware that the hydraulic fluid within the machine may be extremely hot and under high pressure.</p>
---	--

	<p><b>CAUTION</b></p> <p>When installing AutoBoom hydraulics or performing diagnostics, maintenance, or routine service, ensure precautions are taken to prevent any foreign material or contaminants from being introduced into the machine's hydraulic system.</p> <p>Objects or materials that are able to bypass the machine's hydraulic filtration system will reduce performance and possibly damage the AutoBoom hydraulic valve.</p>
---	--

FIGURE 4. Extension Hose Installed on Machine's Pressure Hose



Tank Tee Fitting

1. Disconnect the pressure hose from the machine's stack valve.
2. Install the straight end of the supplied hydraulic hose (P/N 214-1000-592) to the machine's pressure hose.

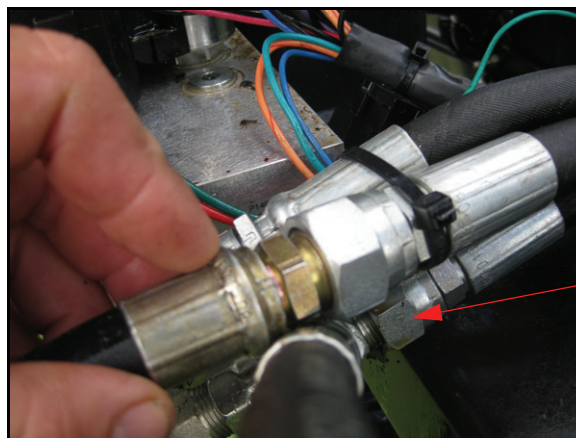
---

**FIGURE 5. Pressure and Tank Lines Installed**

---



3. Connect the 90° end of the installed hydraulic hose to Port P on the AutoBoom valve.
4. Install the straight end of the supplied hydraulic hose (P/N 214-1000-432) to Port P on the machine's hydraulic valve.
5. Connect the 90° end of the installed hydraulic hose to Port EF on the AutoBoom valve.
6. Disconnect the tank hose from the machine's stack valve.
7. Install a 3/4" JIC M/M/F swivel run tee adapter fitting (P/N 333-0012-039) on Port T of the machine's stack valve.
8. Connect the machine's tank hose to the opposite end of the installed tee fitting.
9. Install the straight end of the supplied hydraulic hose (P/N 214-1000-432) on the installed tee fitting.
10. Connect the 90° end of the hydraulic hose to Port T on the AutoBoom valve.

## Install the Left and Right Cylinder Hoses

---

**FIGURE 6. Cylinder Hoses Installed on the AutoBoom Valve**

---

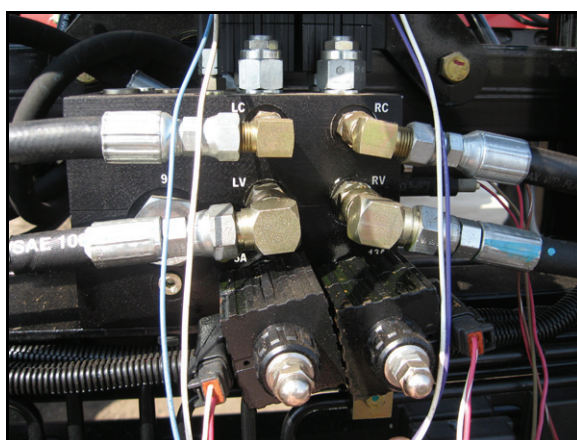

1. Disconnect the machine's raise hoses from the rod-end of the tilt cylinders and route them back to the AutoBoom valve.
2. Connect the machine's right raise hose to Port RV on the AutoBoom valve.
3. Connect the machine's left raise hose to Port LV on the AutoBoom valve.





FIGURE 7. Hydraulic Hoses Installed on Machine's Cylinders

---



4. Install the straight end of the supplied hydraulic hose (P/N 214-1000-295) on the rod-end of the machine's right tilt cylinder.
5. Connect the 90° end of the hydraulic hose to the installed adapter fittings in Port RC on the AutoBoom valve.
6. Install the straight end of the supplied hydraulic hose (P/N 214-1000-291) on the rod-end of the machine's left tilt cylinder.
7. Connect the 90° end of the hydraulic hose to the installed adapter fittings in Port LC on the AutoBoom valve.



# UltraGlide Hydraulic Schematic

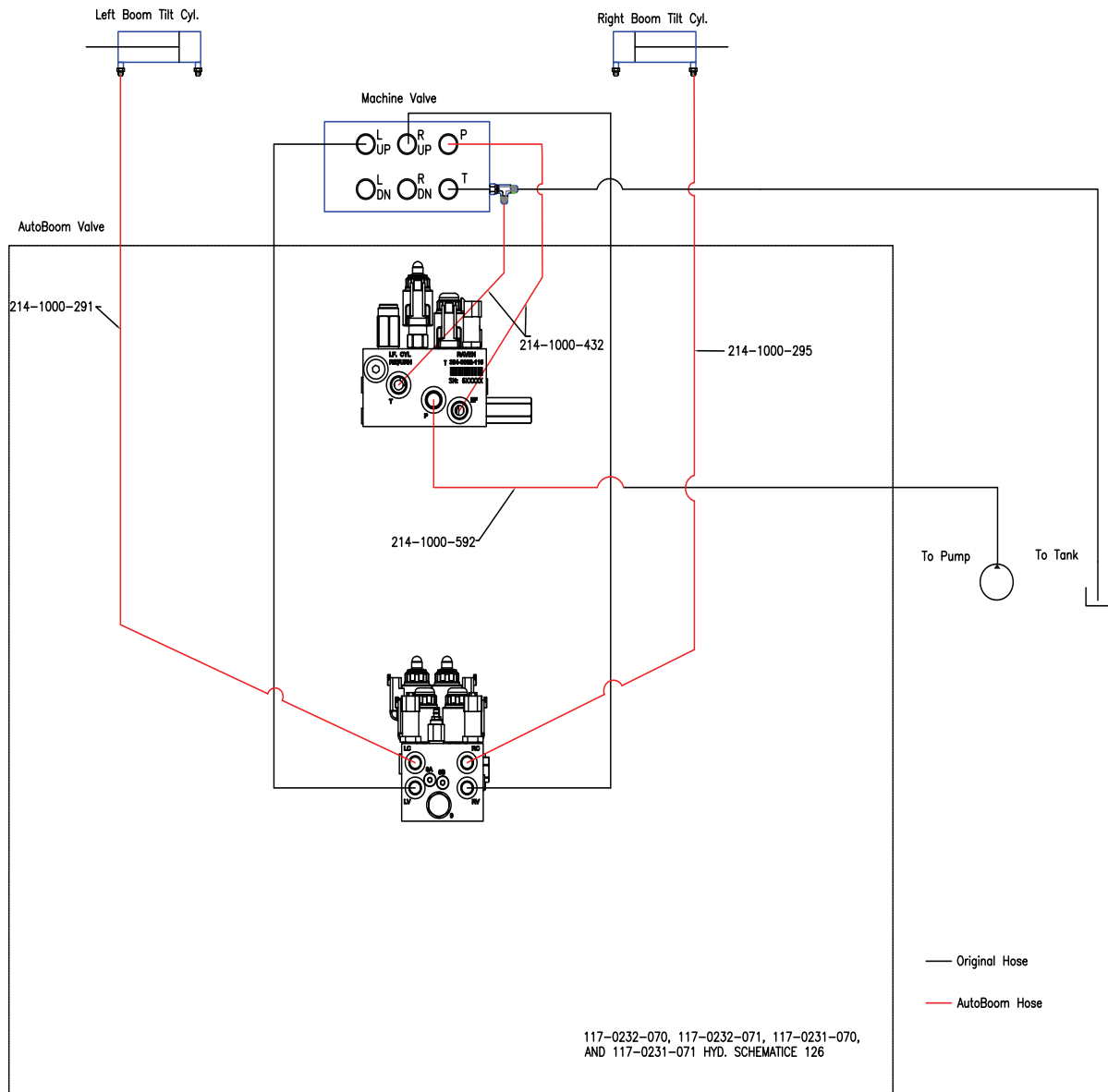

## Boom Sensor Mounting Locations

Sensor mounting locations may be influenced by the boom configuration. If an object enters the sensor's blind range unexpectedly, a false echo return to the sensor could occur, causing the boom to drop and the sensor or boom to be damaged. To ensure optimal operation of the UltraGlide system and to protect the sprayer boom, the sensors should be mounted on the front side of the boom, 8 - 10" above the lowest hanging part of the boom.

FIGURE 8. Illustration of Sensor's Blind Range

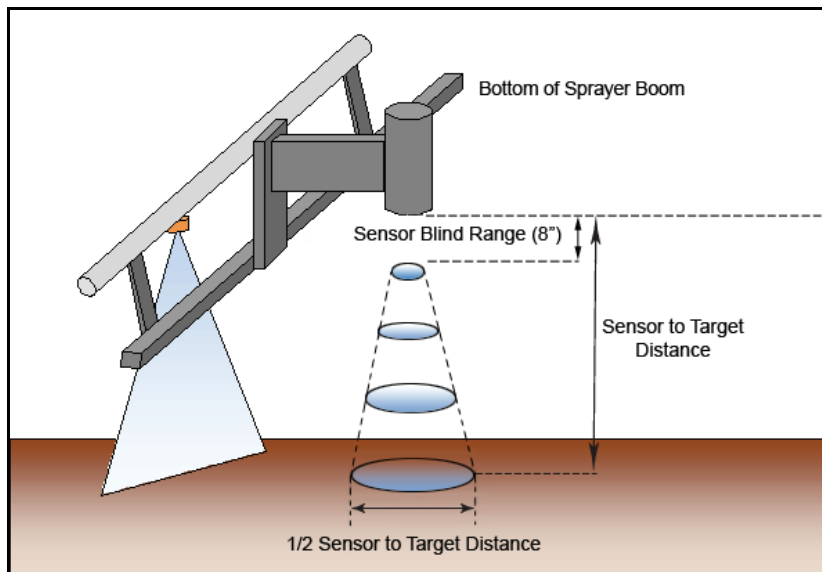

## Mount the Boom Sensors

⚠ **WARNING**

The machine must remain stationary and switched off, with the booms unfolded and supported, during installation or maintenance.

**Note:** After mounting the sensors, fold the booms to verify that the sensors will not interfere with or be damaged by folding the booms. Adjust the sensor location if necessary.

FIGURE 9. Boom Sensor Mounting Location

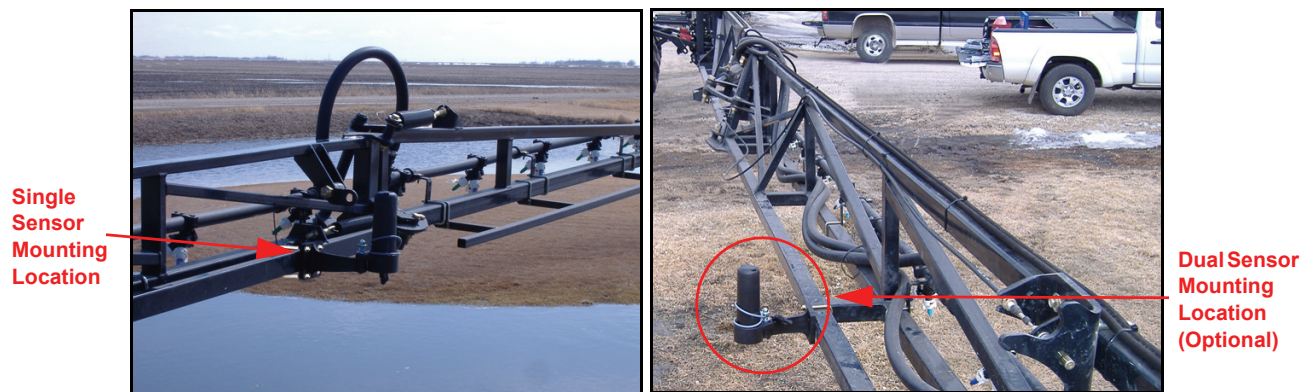

1. Place two 2-9/16" W x 3" L x 3/8" thread U-bolts (P/N 107-0171-614) on the front rail of the left boom.
2. Mount the left sensor (P/N 063-0130-014) on the installed U-bolts.
3. Secure the sensor to the boom by installing four 3/8" zinc flanged lock nuts (P/N 312-1001-164) to the ends of the U-bolts.
4. Tighten the nuts to ensure the sensor is mounted securely.
5. Repeat these steps to mount the remaining boom sensor(s).

## Mount the Center Rack Sensor

FIGURE 10. Center Sensor Mounted to Bracket

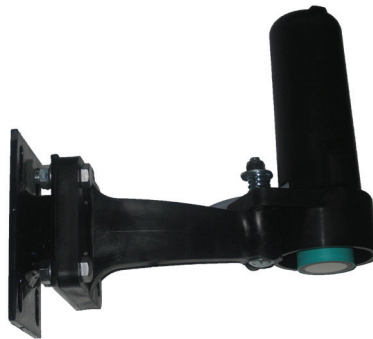

1. Secure the center sensor (P/N 063-0130-018) to the ultrasonic sensor boom mount weldment (P/N 116-0159-684) using four 3/8"-16 UNC x 1-1/4" hex bolts (P/N 311-0054-106) and four 3/8"-16 zinc flanged lock nuts (P/N 312-1001-164).

FIGURE 11. Center Sensor Mounting Location

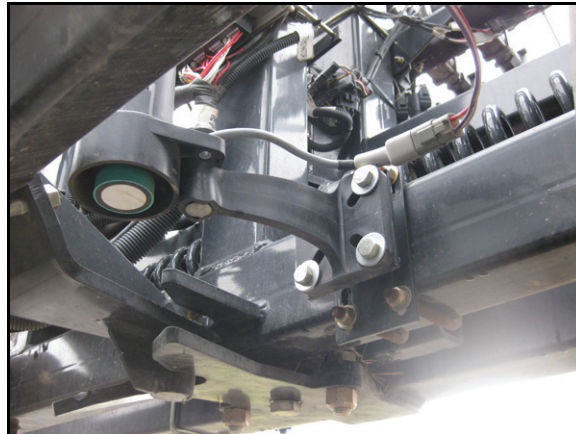

2. Mount the center sensor (P/N 063-0130-018) inside the machine's center rack (toward the machine) using two 3" W x 4" L x 3/8" thread U-bolts (P/N 107-0171-608) and four 3/8" zinc flanged lock nuts (P/N 312-1001-164).
3. Tighten the nuts to ensure the sensor is mounted securely.

### Connect the Sensor Cables

1. Connect the left sensor cable (P/N 115-0171-527) to the connector on the left sensor.
2. Route the left sensor cable toward the AutoBoom valve.
3. Loop and tie-off any excess cable, allowing enough excess cable for boom folding and extension.
4. Repeat the steps above to connect the remaining sensor cables.



**Note:** *The sensor cables will be connected to the AutoBoom system in the wiring phase of installation.*

## Install the Gauge Wheels - Optional

### Gauge Wheel Mounting Locations

Wheel mounting locations may be influenced by the boom configuration. Determine the appropriate location for mounting the wheels on the boom, ensuring the wheels will not interfere with or be damaged while folding or unfolding the booms.

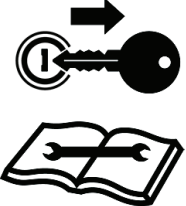
### Mount the Gauge Wheels

	<div style="background-color: #e67e22; color: white; padding: 5px; text-align: center;">  <b>WARNING</b> </div> <p>The machine must remain stationary and switched off, with the booms unfolded and supported, during installation or maintenance.</p>
---	---

**Note:** *The appearance of the wheel axles may vary.*

FIGURE 12. Gauge Wheel Installed



1. Remove the lug nuts from the right wheel axle (P/N 063-0131-589).
2. Place the wheel (P/N 322-0131-008) on the right wheel axle.
3. Reinstall the lug nuts on the wheel axle to secure the wheel.
4. Attach the right wheel mounting bracket (P/N 116-0159-658) to the back of the right boom by installing four 2-1/16" W x 3" L x 3/8" thread U-bolts (P/N 107-0171-609) through the back of the mounting bracket and securing them with eight 3/8" zinc flanged lock nuts (P/N 312-1001-164).
5. Insert the left wheel axle into the left wheel mounting bracket, positioning it so that the bottom of the wheel touches the ground (or nearly so) and the wheel faces away from the machine.
6. Secure the gauge wheel assembly in the wheel mounting bracket by installing two 1/2"-13 x 1-1/2" SS hex bolts (P/N 311-0058-186) and two 1/2" zinc hex nuts (P/N 312-1001-043).
7. Repeat the steps above to install the left wheel.

## Install the UltraGlide Wiring

### Wiring Connections

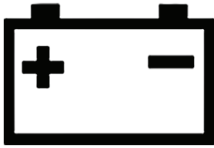
	<p><b>⚠ CAUTION</b></p> <p>Always connect the power cable as the last step in the wiring process and verify that the power leads are connected with the correct polarity. Reversing power leads can cause severe damage to the equipment.</p>
---	---

For wiring connections made outside of the cab, apply dielectric silicone grease (P/N 222-0000-006) generously on both the male and female ends of the connectors. Application of the grease will prevent corrosion to the pins and wires.

### Install the AutoBoom Node

FIGURE 13. UltraGlide AutoBoom Node Installed

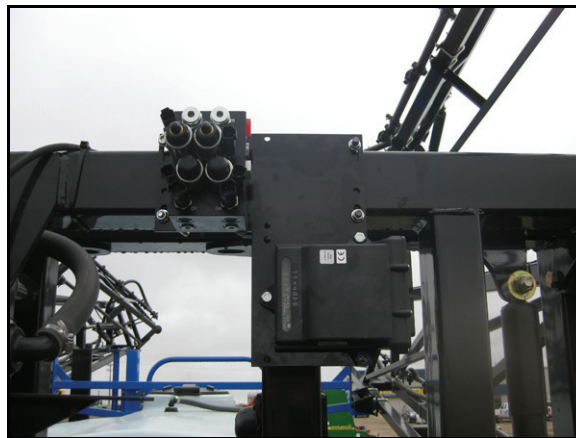

1. Mount the AutoBoom node (P/N 063-0130-013) to the AutoBoom valve mounting plate (P/N 107-0171-802) using three 3/8"-16 zinc hex bolts (P/N 311-0054-106) and three 3/8"-16 zinc flanged lock nuts (P/N 312-1001-164).

**Note:** Make sure that the node is positioned so that the cable connectors face down or to the side.

2. Insert the large, rectangular node connectors on the harness cable (P/N 115-0230-045 or 115-0230-085) into the correct ports of the AutoBoom valve.
3. Tighten the bolts on the node connectors to secure the connections.

### Connect the Harness Cable to the Boom Function Controls

1. Locate the Left Press and Right Press connectors on the harness cable (P/N 115-0230-045 or 115-0230-085).
2. Route the connectors to the AutoBoom valve (P/N 063-0131-126).
3. Connect the Left Press connector to Port G1 on the AutoBoom valve.



4. Connect the Right Press connector to Port G4 on the AutoBoom valve.
5. Locate the Left Solenoid and Right Solenoid connectors on the harness cable.
6. Connect the Left Solenoid connector to Port 4A on the AutoBoom valve.
7. Connect the Right Solenoid connector to Port 4B on the AutoBoom valve.
8. Locate the Left Prop and Right Prop connectors on the harness cable.
9. Connect the Left Prop connector to Port 5A on the AutoBoom valve.
10. Connect the Right Prop connector to Port 13A on the AutoBoom valve.

**FIGURE 14. Machine's Left and Right Tilt Boom Function Coils**

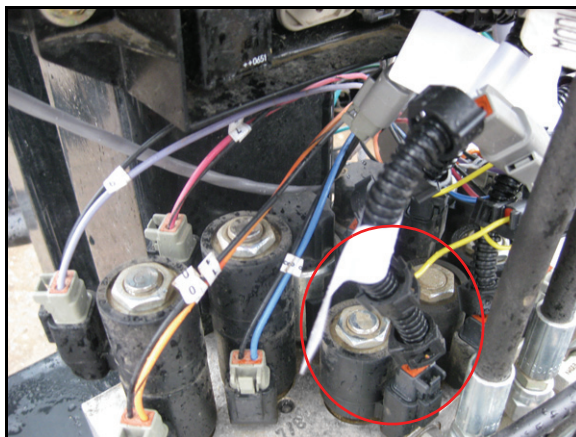

11. Locate the machine's boom function coils near the machine's hydraulic valve.
12. Disconnect the connector from the left tilt up coil.
13. Install a boom sense adapter cable (P/N 115-0171-546) between the coil and the machine's coil connector.
14. Connect the boom sense adapter cables between the left tilt down, right tilt up, and right tilt down coils and the coil connectors.
15. On the harness cable, locate the Left Solenoid Sense connectors. Isolate the connector labeled Up and connect it to the left tilt up coil via the installed boom sense adapter cable.
16. Connect the down Left Solenoid Sense connector to the left tilt down coil via the installed boom sense adapter cable.
17. Connect the Right Solenoid Sense connectors to the machine's right tilt up and right tilt down coils via the installed boom sense adapter cables.

## Install the Center Rack Control

FIGURE 15. Machine's Center Boom Function Coils

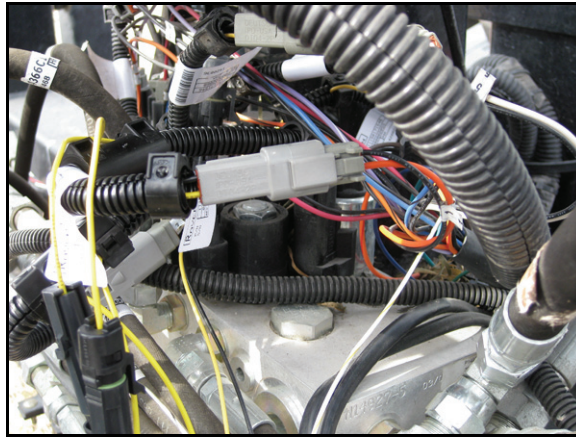

1. Locate the center up coil on the machine's stack valve.
2. Unplug the coil connector from the center up coil.
3. Install a center rack control boom sense adapter cable (P/N 115-0230-039) to the machine's Up coil.
4. Connect the coil connector to the installed boom sense adapter cable.
5. Plug the single connectors on the installed boom sense adapter cable in the Center Up harness connectors on the AutoBoom valve harness (P/N 115-0230-045 or 115-0230-085).
6. Locate the center down coil on the machine's stack valve.
7. Unplug the coil connector from the center down coil.
8. Install a center rack control boom sense adapter cable (P/N 115-0230-039) to the machine's Down coil.
9. Connect the coil connector to the installed boom sense adapter cable.
10. Plug the single connectors on the installed boom sense adapter cable in the Center Down harness connectors on the AutoBoom valve harness (P/N 115-0230-045 or 115-0230-085).

FIGURE 16. Open Center Dump Valve Coil

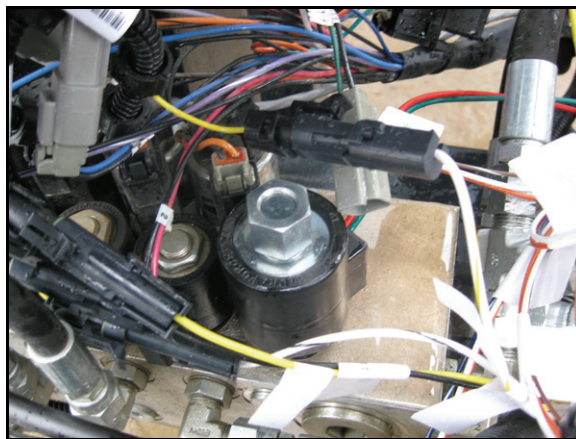

11. Locate the open center dump valve coil on the machine's hydraulic valve.
12. Unplug the coil connector from the open center dump valve coil.
13. Install a boom sense adapter cable (P/N 115-0171-546) on the coil.



14. Connect the coil connector to the installed boom sense adapter cable.
15. Locate the Open Center valve connector on the AutoBoom harness cable and connect it to the boom sense adapter cable installed on the open center dump valve coil.

## Connect the Harness Cable to the Sensors

1. Locate the Center Sensor connector on the AutoBoom harness cable.
2. Connect the Center Sensor connector to the installed center sensor (P/N 063-0130-018).
3. Locate the Left Outer Sensor connector on the AutoBoom harness cable.
4. Connect the Left Outer Sensor connector to the installed left sensor cable (P/N 115-0171-527).
5. Locate the Right Outer Sensor connector on the AutoBoom harness cable.
6. Connect the Right Outer Sensor connector to the installed right sensor cable.
7. If optional inside boom sensors are installed, repeat the steps above to connect the sensor cables.

## Connect the Harness Cable to the Implement Extension Tee - Gen II Cable Only

1. Route the harness cable (P/N 115-0230-085) toward the implement extension tee cable.
2. Connect the harness cable to the To Node connector.
3. Remove the terminator from the machine's chassis harness or the standalone console harness.
4. Install the terminator on the remaining open end of the implement extension tee cable.
5. Refer to the wiring schematic (beginning on page 59) appropriate for the machine's configuration to route the implement extension tee cable.
6. Connect the implement extension tee cable to the location determined in the step above.

## Connect the Harness Cable to the Controller Cable - Gen I Cable Only

1. Route the harness cable (P/N 115-0230-045) toward the machine's cab.
2. Connect the harness cable to the controller cable (P/N 115-0230-007).
3. Tighten the connector screw cap to secure the connection.

## Connect the Controller (If Applicable) - Gen I Cable Only

1. Route the controller cable (P/N 115-0230-007) into the right side of the machine's cab.
2. Locate the two controller connectors and connect them to the AutoBoom controller (P/N 063-0130-021).

**Note:** *The AutoBoom controller should be mounted in the machine's cab so that the machine's operator has easy access to it.*

## Connect the Field Computer (If Applicable)

Refer to the Installation & Operation Manual and the appropriate wiring schematic beginning on page 59 for installation and wiring instructions for your specific field computer.



## **Connect the Power Leads**

1. Locate the power cable that has the red and white power leads at one end.
2. Disconnect the machine's connectors from the battery terminals.
3. Install the red power lead on the positive battery terminal and reinstall the machine's battery connector.
4. Install the white power lead on the negative battery terminal and reinstall the machine's battery connector.

# UltraGlide Wiring Schematic

## Gen I Cabling

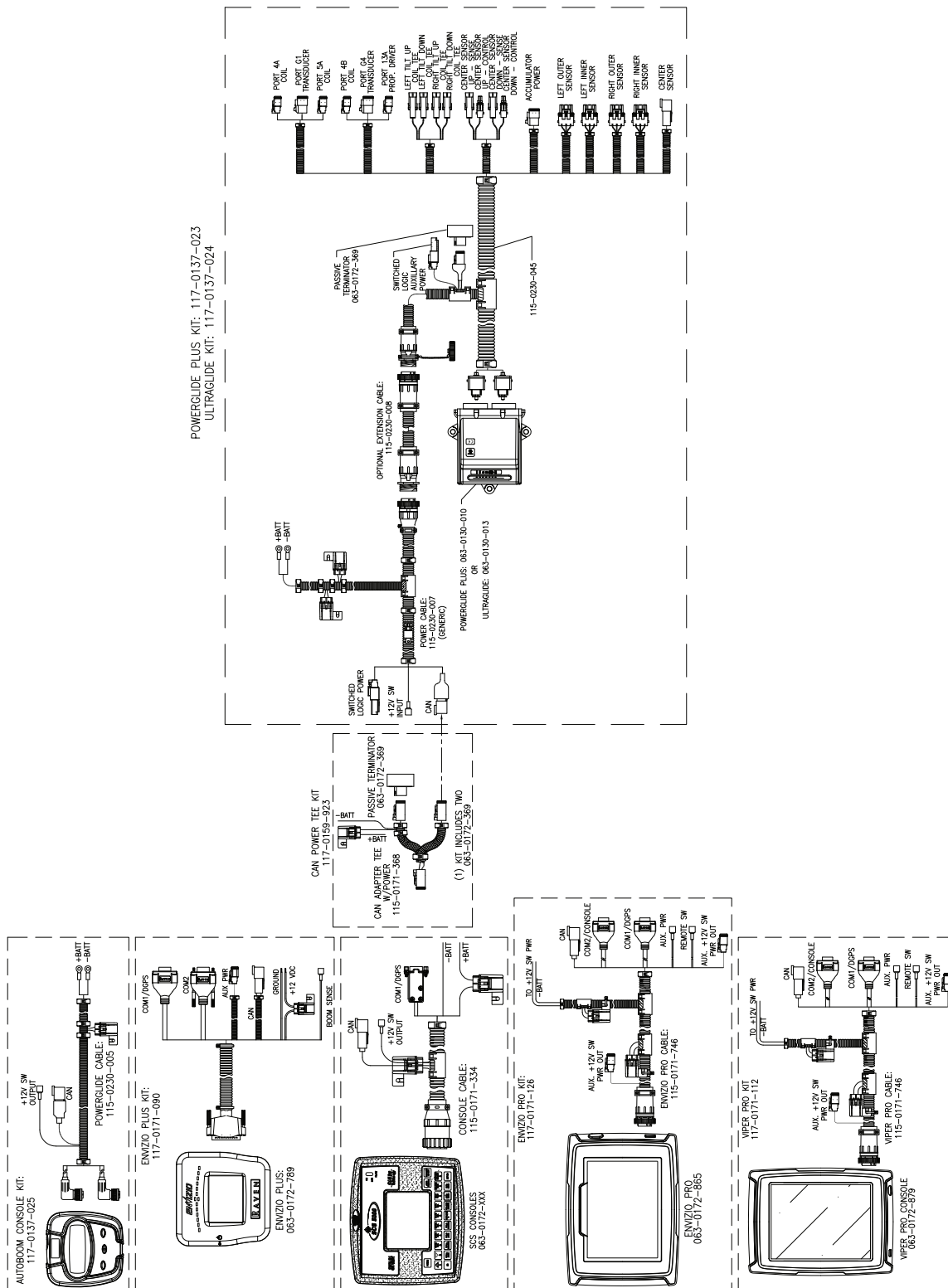



**CHAPTER**

**6**

***Replacement Parts***

This section contains replacement part diagrams and listings for PowerGlide, PowerGlide Plus, and UltraGlide systems. Please refer to these diagrams when calling to request replacement parts.

**PowerGlide Valve Block Replacement Parts**

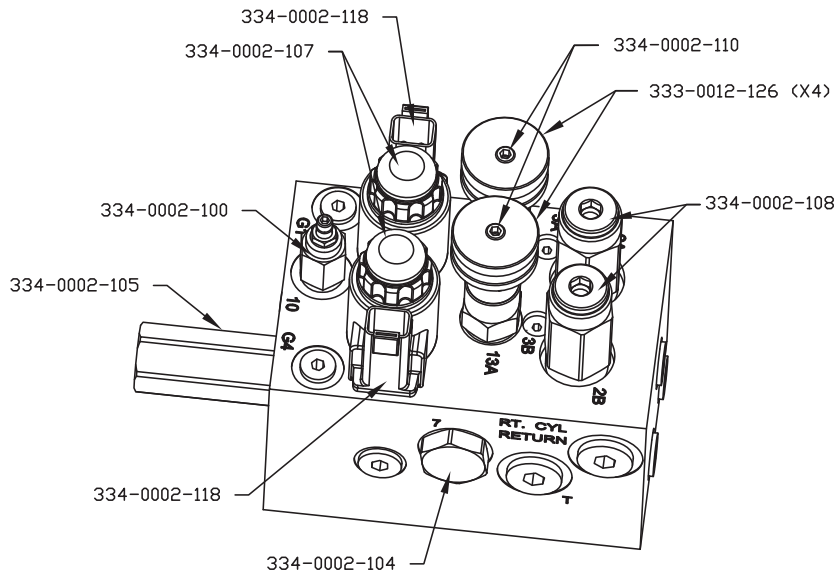

063-0131-127  
VALVE, HYDRAULIC POWERGLIDE,  
OPEN CENTER, AUTOBOOM

## PowerGlide Plus and UltraGlide Valve Block Replacement Parts

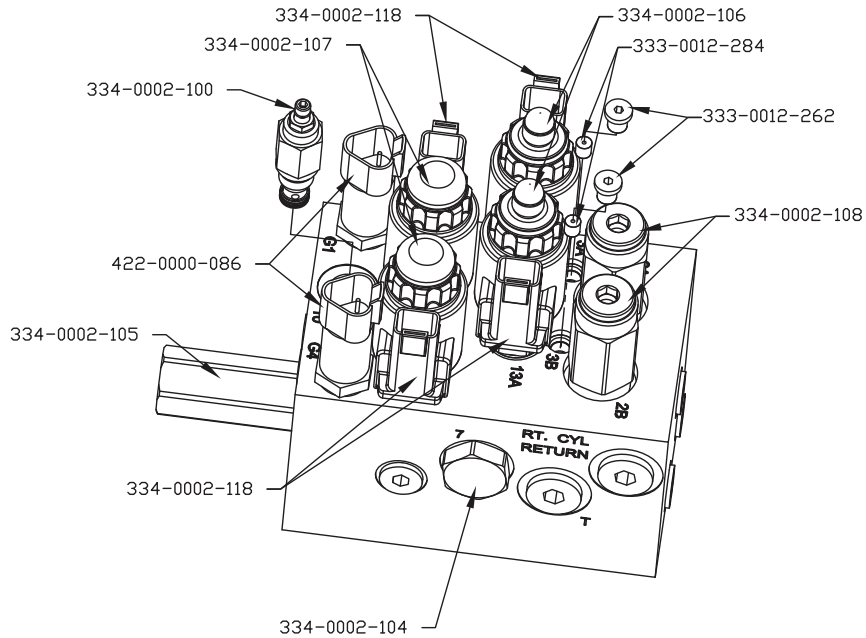

063-0131-126  
VALVE, HYDRAULIC POWERGLIDE  
PLUS/ULTRAGLIDE, OPEN CENTER, AUTOBOOM

## Wheels

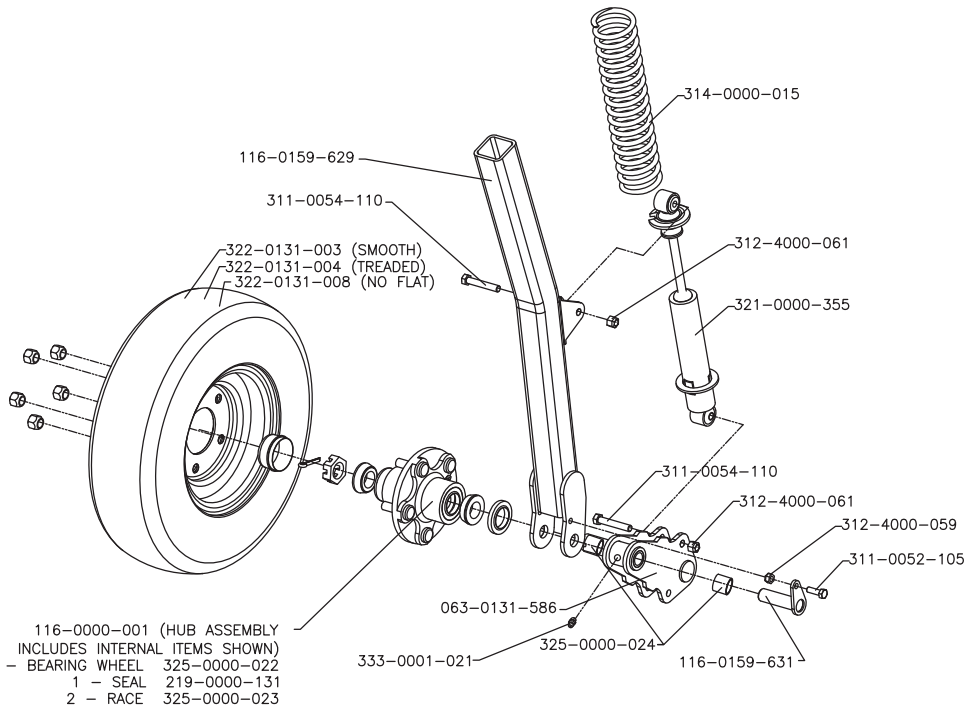

# Sensors

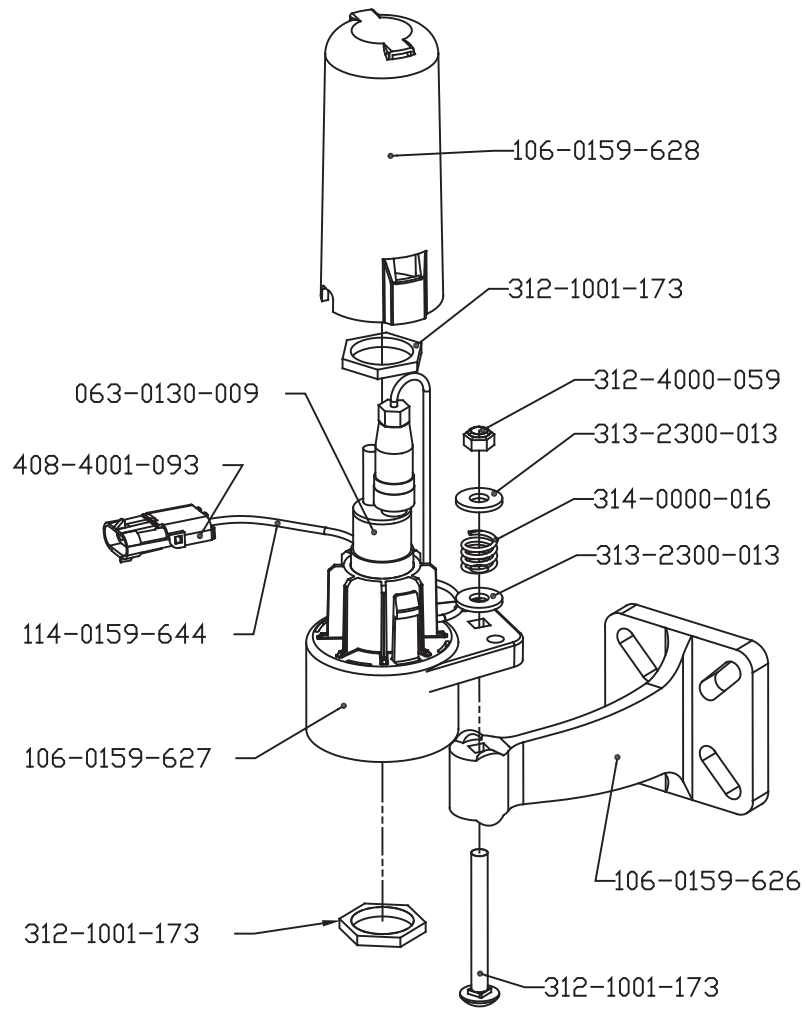





**E****Electrical Safety** 2**H****Hydraulic Fittings** 4**Hydraulic Safety** 2**I****Important Safety Information**

Electrical Safety 2

Hydraulic Safety 2

**Introduction** 3**K****Kit Contents**

PowerGlide 5

PowerGlide Plus 19

UltraGlide 39

**P****Point of Reference** 4**PowerGlide** 5

Install

Gauge Wheels 15

Hydraulic System 8

Converting the Hydraulic Valve to Open Center 9  
Fittings 9

Left and Right Cylinder Hoses 12

Mount the AutoBoom Valve 10

PowerGlide Hydraulic Schematic 14

Pressure and Tank Hoses 11

Wiring 16

Connecting Controller 17

Connecting Harness Cable 17

Connecting Power Leads 17

Connecting the Harness Cable to the Boom Func-  
tion Controls 16

Connections 16

PowerGlide Wiring Schematic 18

Kit Contents 5

**PowerGlide Plus** 19

Install

Gauge Wheels 32

Gauge Wheel Mounting Locations 32

Mounting the Gauge Wheels 32

Hydraulic System 23

Converting the Hydraulic Valve to Open Center 23  
Fittings 26

Left and Right Cylinder Hoses 29

Mount the AutoBoom Valve 27

PowerGlide Plus Hydraulic Schematic 31

Pressure and Tank Hoses 28

Removing the Orifice Fittings 24

Wiring 33

AutoBoom Node 33

Connecting the Controller 35

Connecting the Field Computer 35

Connecting the Harness Cable to the Boom Func-  
tion Controls 33

Connecting the Harness Cable to the Controller

Cable 34

Connecting the Harness Cable to the Controller Ca-  
ble - Gen I Cable Only 35Connecting the Harness Cable to the Implement  
Extension Tee - Gen II Cable Only 34

Connecting the Harness to the Controller Cable 34

Connecting the Power Leads 35

Connections 33

Wiring Schematics

Gen I Cabling 36

Gen II Cabling 37

Kit Contents 19

**Preparing for Installation** 4**R****Recommendations** 4**Replacement Parts** 61

Sensors and Brackets 63

Valve Blocks

PowerGlide 61

PowerGlide Plus and UltraGlide 62

**T****Tools Needed** 4**U****UltraGlide** 39

Install

Gauge Wheels 53

Gauge Wheel Mounting Locations 53

Mounting the Gauge Wheels 53

Hydraulic System 43

Converting the Hydraulic Valve to Open Center 44  
Fittings 44

Left and Right Cylinder Hoses 47

Mount the AutoBoom Valve 45

Pressure and Tank Hoses 46

UltraGlide Hydraulic Schematic 49

Sensors

Boom Sensor Mounting Locations 50

Connecting Sensor Cables 52

Mounting the Boom Sensors 50

Wiring 54

AutoBoom Node 54

Connecting the Controller 57

Connecting the Field Computer 57

Connecting the Harness Cable to the Boom Func-  
tion Controls 54Connecting the Harness Cable to the Controller Ca-  
ble - Gen I Cable Only 57Connecting the Harness Cable to the Implement  
Extension Tee - Gen II Cable Only 57

Connecting the Harness Cable to the Sensors 57

Connecting the Power Leads 58

Connections 54

Installing the Center Rack Control 56

Wiring Schematics

Gen I Cabling 59

Gen II Cabling 60

Kit Contents 39



**RAVEN**

# **RAVEN INDUSTRIES**

## **Limited Warranty**

---

### ***What Does this Warranty Cover?***

This warranty covers all defects in workmanship or materials in your Raven Applied Technology Division product under normal use, maintenance, and service.

### ***How Long is the Coverage Period?***

Raven Applied Technology Division products are covered by this warranty for 12 months after the date of purchase. This warranty coverage applies only to the original owner and is nontransferable.

### ***How Can I Get Service?***

Bring the defective part and proof of purchase to your Raven dealer. If your dealer agrees with the warranty claim, the dealer will send the part and proof of purchase to their distributor or to Raven Industries for final approval.

### ***What Will Raven Industries Do?***

Upon confirmation of the warranty claim, Raven Industries will, at our discretion, repair or replace the defective part and pay for return freight.

### ***What is not Covered by this Warranty?***

Raven Industries will not assume any expense or liability for repairs made outside our facilities without written consent. Raven Industries is not responsible for damage to any associated equipment or products and will not be liable for loss of profit or other special damages. The obligation of this warranty is in lieu of all other warranties, expressed or implied, and no person or organization is authorized to assume any liability for Raven Industries.

Damages caused by normal wear and tear, misuse, abuse, neglect, accident, or improper installation and maintenance are not covered by this warranty.