

# SYSTEM DRAWING, DIRECSTEER, GENERIC, W/ IBBC, RS1, CR12

KIT, RS1  
117-5001-037 THRU-049

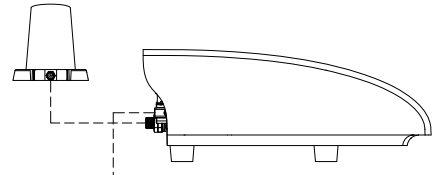

KIT, SC1+500S  
117-5000-001/004

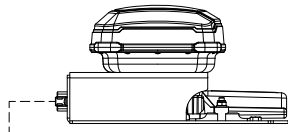

KIT, CONSOLE, CR12, UT UNLOCK  
117-2300-001/-005  
KIT, CONSOLE, VIPER 4+ ROS, UT UNLOCK  
117-5010-068/-069

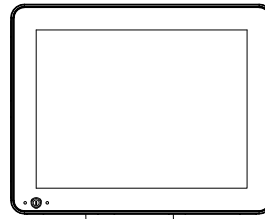

KIT, INSTALL, VIPER 4(+)/CR12, RS1  
117-2300-002/-003

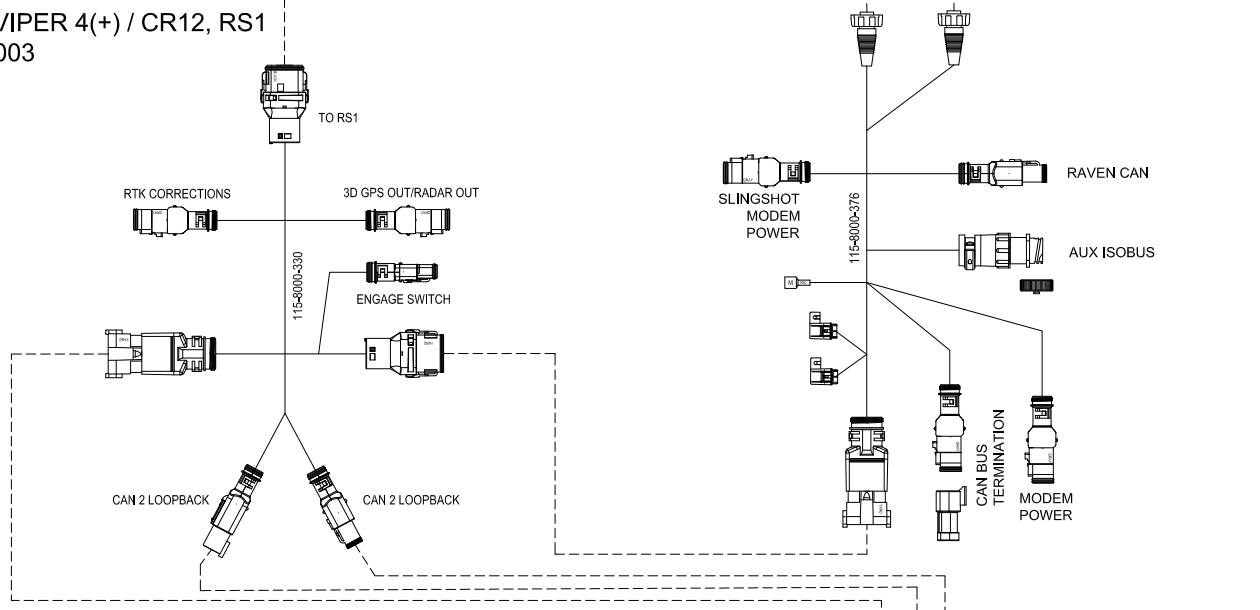

117-5030-314  
KIT, DIRECSTEER, MOTOR,  
ANTI-ROTATION BRACKET

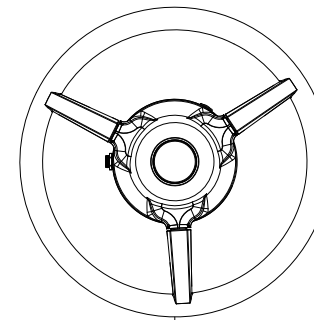

117-5030-313  
KIT, DIRECSTEER, GENERIC, W/ IBBC, RS1

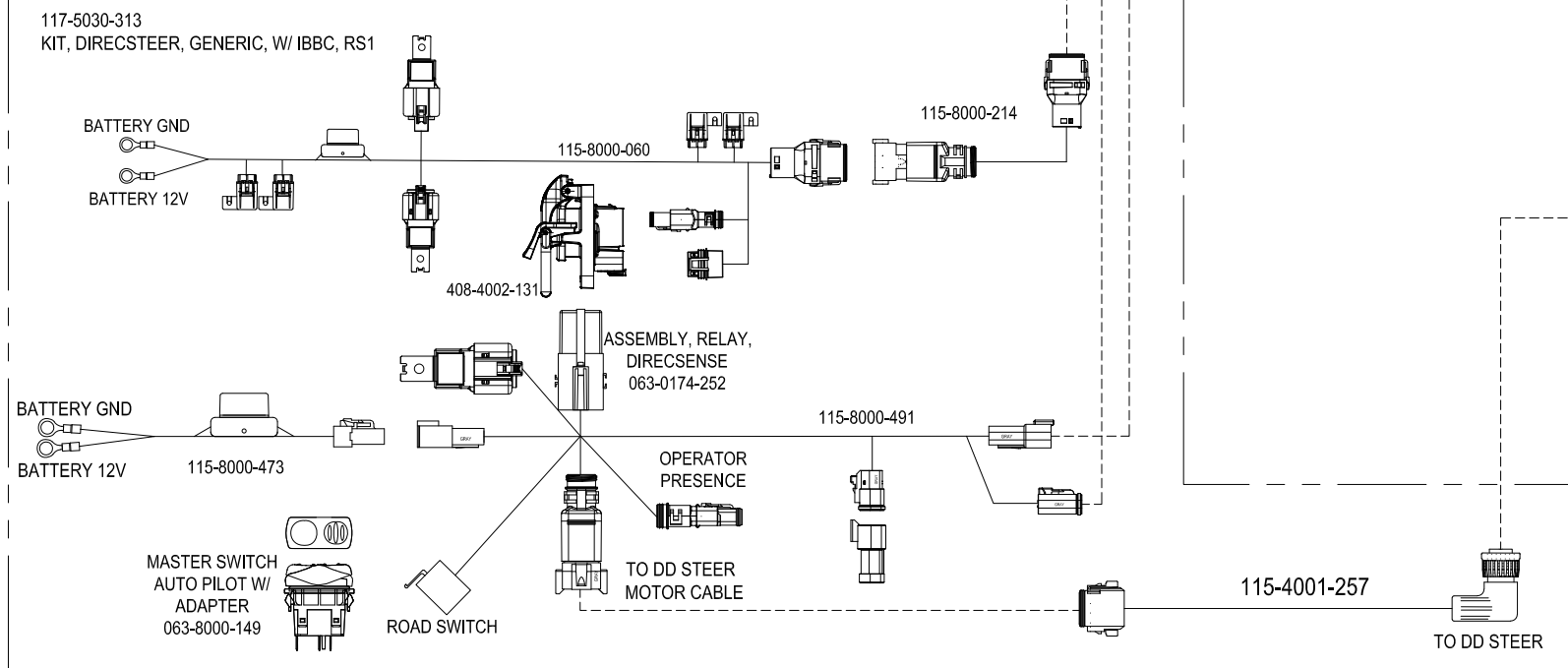

RELEASED DATE	ECO #	REV.	DRAWING NO.
6/08/23	46547	A2	054-5030-313
3/26/24	48786	B	054-5030-313

# SYSTEM DRAWING, DIRECSTEER, GENERIC, W/ IBBC, RS1, CR7

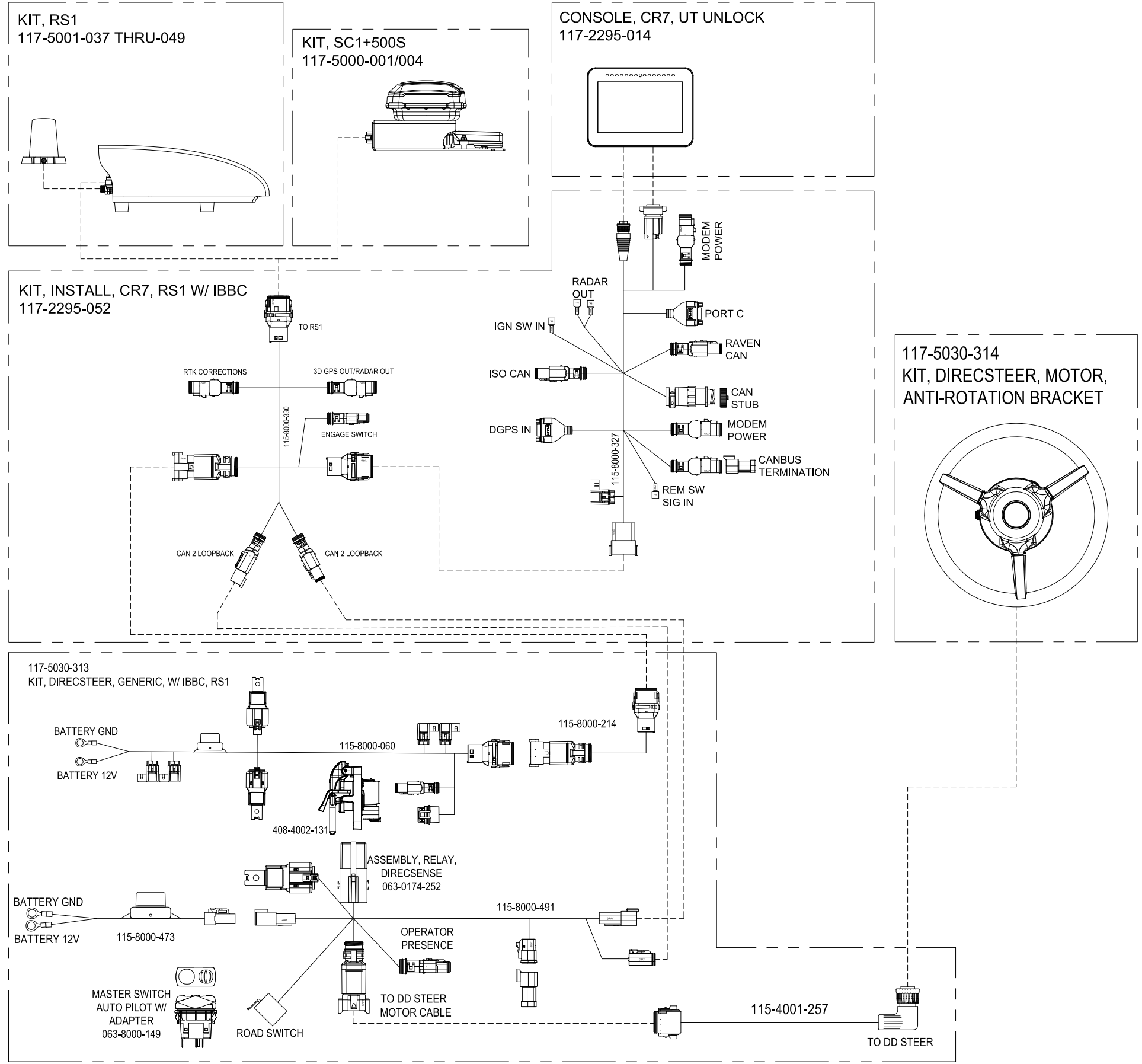

RELEASED DATE	ECO #	REV.	DRAWING NO.
6/08/23	46547	A2	054-5030-313
3/26/24	48786	B	054-5030-313