

**RS1™/SC1™ with DirecSteer**  
**Installation Manual for Case**  
**IH Magnum, MX, Steiger, STX, & New**  
**Holland T8, T80XX, TG, T9, T90XX TJ**



10165030402

P/N 016-5030-402-B Jan 2024 E48064

Copyright © 2023, 2024

---

## Disclaimer

---

While every effort has been made to ensure the accuracy of the information presented on this site, Raven Industries assumes no responsibility for omissions and errors. Nor is any liability assumed for damages resulting from the use of information contained herein.

Raven Industries shall not be responsible or liable for incidental or consequential damages or a loss of anticipated benefits or profits, work stoppage or loss, or impairment of data arising out of the use, or inability to use, this system or any of its components. Raven Industries shall not be held responsible for any modifications or repairs made outside our facilities, nor damages resulting from inadequate maintenance of this system.

As with all wireless and satellite signals, several factors may affect the availability and accuracy of wireless and satellite navigation and correction services (e.g. GPS, GNSS, SBAS, etc.). Therefore, Raven Industries cannot guarantee the accuracy, integrity, continuity, or availability of these services and cannot guarantee the ability to use Raven systems, or products used as components of systems, which rely upon the reception of these signals or availability of these services. Raven Industries accepts no responsibility for the use of any of these signals or services for other than the stated purpose.

---

# Table of Contents

---

<b>Disclaimer</b> .....	<b>a</b>
<b>Table of Contents</b> .....	<b>i</b>
<b>Important Safety Information</b> .....	<b>1</b>
Field Computers, Displays, and Control Consoles .....	2
Hydraulic Safety .....	2
Electrical Safety .....	3
Machine Safety Systems .....	4
Touch Screen .....	4
Recommendations and Best Practices .....	5
Point of Reference .....	5
Preparing for Install .....	5
Aerials and Signal Interference .....	5
Hose Routing .....	6
Harness Routing .....	7
<b>Introduction</b> .....	<b>11</b>
Kit Contents .....	13
Specialized Tool Recommendations .....	16
Updates .....	16
<b>DirecSteer Installation</b> .....	<b>19</b>
Prepare for the Installation .....	19
Recommendations .....	20
Point of Reference .....	20
Remove the Steering Wheel .....	21
Install the Anti-Rotation Brackets .....	23
Install the DirecSteer Assembly .....	27

---

Prepare the DirecSteer Assembly .....	27
Attach Brackets to the Assembly .....	28
Attach the DirecSteer Assembly to the Steering Column .....	30
Remove the DirecSteer Assembly .....	31
<b>Install the Field Computer .....</b>	<b>33</b>
<b>Assemble the Antenna Receiver .....</b>	<b>37</b>
Install the RS1™ to Bracket .....	37
Insert a SIM Card in the RS1™ .....	37
Attach RS1™ to the Mounting Bracket .....	38
Install the SC1™/TC1™ and 500S™ to Bracket .....	38
<b>Install the Antenna Receiver .....</b>	<b>43</b>
Mount with Adhesive Bracket .....	43
Mount Antenna Receiver to Roof .....	47
<b>Cable Routing .....</b>	<b>49</b>
DirecSteer System Diagrams .....	49
Best Routing Practices .....	50
Route the DirecSteer Cables .....	51
Connect to Power .....	57

## Chapter 1:

# Important Safety Information

---

### **NOTICE**

Follow the operation and safety instructions included with the implement and/or controller and read this manual carefully before installing, servicing, or operating this Raven system.

- Park the machine where the ground is level, clean, and dry.
- Bleed pressure from the hydraulic system and leave the machine turned off for the duration of the installation or maintenance process.

Follow the operation and safety instructions included with the implement and/or controller. Before installing or operating this Raven system, review and understand the information presented on this site.

- Failure to follow safety instructions may lead to equipment damage, personal injury, or death.
- Review equipment operation with your local dealer and follow all safety information presented on this site.
- Contact a local Raven dealer for assistance with any portion of the installation, service, or operation of Raven equipment.
- Follow all safety labels affixed to system components. Be sure to keep safety labels in good condition and replace any missing or damaged labels. Contact a local Raven dealer to obtain replacements for safety labels.

Observe the following safety measures when operating the implement after installing this Raven system:

- Do not operate this Raven system or any agricultural equipment while under the influence of alcohol or an illegal substance.

- Be alert and aware of surroundings while operating this Raven system.
  - Determine and remain a safe working distance from obstacles and bystanders. The operator is responsible for disabling the system when a safe working distance has diminished.
  - Do not operate the implement on any public road with this Raven system enabled.
  - Maintain control of the vehicle at all times during operation. For example,
    - Remain in the operator seat while the system is enabled and disable automated Raven controls before exiting the operator seat.
    - Maintain control of safety devices such as E-Stops at all times during operation.
  - Disable this Raven system prior to starting any maintenance work on the implement or components of this Raven system.
- Do not attempt to modify or lengthen any of the system control cables. Extension cables are available from a local Raven dealer.

## Field Computers, Displays, and Control Consoles

- If the display will not be used for an extended period, it is best to remove the display from the machine and store it in a climate controlled environment. This may help to extend the service life of electronic components.
- To prevent theft, secure the display and GNSS antenna when leaving the machine unattended.



## Hydraulic Safety

When installing or servicing a hydraulic system or hydraulic components, be aware that hydraulic fluid may be extremely hot and under high pressure. Caution must be exercised.

- Always wear appropriate personal protective equipment when installing or servicing hydraulic systems.
- Never attempt to open or work on a hydraulic system with the implement running.
- Always take care when servicing or opening a system that has been pressurized.

- The implement or machine must remain stationary and switched off with booms or implement sections unfolded and supported during installation or maintenance.
- Any work performed on the hydraulic system must be done in accordance with the machine manufacturer's approved maintenance instructions.
- Before installing hydraulic components, ensure there are no issues with the machine hydraulic system (e.g. pump issues, faulty hydraulic motors, fine metal deposits in the hydraulic lines, etc.).
- Take precautions to prevent foreign material or contaminants from being introduced into the implement hydraulic system. Contaminants that are able to bypass the hydraulic filtration system will reduce performance and may damage hydraulic components.
  - Verify that the hydraulic system is using fresh oil and the filters have been changed.
- Stand clear of the implement when starting the system for the first time after installing or servicing hydraulic components in case a hose has not been properly connected or tightened.

 **CAUTION**

## Electrical Safety

- Always verify that power leads are connected to the correct polarity as marked. Reversing the power leads could cause severe damage to the Raven system or other components.
- To prevent personal injury or fire, replace defective or blown fuses with only fuses of the same type and amperage.
- Do not connect the system power cable to the vehicle ignition or battery until all system components are mounted and all electrical connections are completed.
- Always start the machine before initializing this Raven system to prevent power surges or peak voltage.
- To avoid tripping and entanglement hazards, route cables and harnesses away from walkways, steps, grab bars, and other areas used by the operator or service personnel when operating or servicing the equipment.

- Provided power leads may be shortened by properly trained individuals only. No other modifications to cabling are allowed e.g. increasing power lead lengths, or modifying any other aspect of cabling in the system. If power leads are shortened they must be terminated with provided spare ring terminals or with installer supplied ring terminals listed by the ring terminal manufacture as being compatible with the wire gauge being used.

## Machine Safety Systems

- Use all provided safety systems on the machine when operating the machine with the Raven system.
- Seat belts and restraints must be used when an operator is in the cab.
- Do not disable any machine-provided safety systems, including but not limited to audible alarms, alarm lights, etc.

## Touch Screen

- Only touch the touch-screen with your finger or by using a special touch-screen stylus or pen. Operating the touch-screen with sharp objects may cause permanent damage to the screen.
- Only clean the screen using a damp cloth. Never use caustic or other aggressive substances.



## Recommendations and Best Practices

### Point of Reference

Instructions provided generally assume you are standing behind the machine facing toward the cab. More specific orientation may be provided as necessary to complete procedures.

### Preparing for Install

- Ensure there are no issues with the machine hydraulic system (e.g., pump issues, faulty hydraulic motors, fine metal deposits in the hydraulic hoses, etc.).
- Verify that the machine hydraulic system is using fresh oil and that the filters have been recently changed.
- Ensure there are no issues with the steering system (e.g., worn bushings, faulty tie rod ends, improperly adjusted steering components, etc.)

### Aerials and Signal Interference

Due to the relatively low broadcast power from satellites, all GNSS receivers and aerials tend to be susceptible to sources of signal noise and interference as compared to terrestrial signals (i.e. radio or cellular).

**Note:** *Poor GNSS signal reception may cause other systems which rely on GNSS solutions (e.g. auto-steer systems, rate control systems, etc.) to disengage or may cause undesired operation or results.*

The following recommendations are intended to provide an optimal environment for GNSS systems and provide the best up-time results, even as sources of interference may spike throughout the day.

- Mount GNSS antennas with a clear, unobstructed view of the sky.
  - A minimum clearance of 1 m [39 in] is recommended around the GNSS antenna to help avoid common issues with signal interference. Do not mount cellular, radio, or other GNSS antennas within this area.
  - Mount the GNSS antenna to the tallest point of the machine. Avoid mounting the antenna in a location where obstructions (e.g. bins/hoppers, cab roof lines, equipment frame or structural elements, etc.) may rise into the antenna view.

**Note:** *The antenna view typically starts 5° to 10° above horizontal from the base of the antenna and extends over the skyward face of the receiver/antenna.*
- GNSS is a line-of-sight system. A clear path must exist between the satellite and the GNSS antenna.
  - Obstructions such as buildings, tree branches and limbs, as well as components of the vehicle such as a fiberglass or metal roof, and etc. may cause signal multi-path or completely block the GNSS receiver.
- Electrical and magnetic fields can interfere with GNSS or L-Band signals.
  - Avoid mounting GNSS receivers or antennas near components such as radio or cellular antennas, electrical motors, generators, alternators, strobe lights, radio transmitters, radio or cellular antennas, etc.
  - Over-head power lines, microwave dishes, radar, other active antennas, etc. can interfere with GNSS signal.
- Mount the Field Hub cellular and diversity antennas at least 1 m [39 in] apart. Avoid mounting other cellular, radio, or GNSS aerials within this area.

## Hose Routing

The word “hose” is used to describe any flexible, fluid carrying components. Use the following guidelines and recommendations when connecting and routing hoses while installing or maintaining this Raven system:

- Leave protective caps/covers over hose ends until connecting the end into the hydraulic system to help prevent contaminants from entering the system.

- Follow existing hose runs already routed on the implement as much as possible.  
Proper hose routing should:
  - Secure hoses and prevent hoses from hanging below the implement.
  - Provide sufficient clearance from moving components and operational zones around shafts; universal joints and suspension components; pulleys, gears, belts, and chains; moving linkages, cylinders, articulation joints, etc.
  - Protect hoses from field debris and surrounding hazards (e.g. tree limbs, fence posts, crop stubble, dirt clumps or rocks that may fall or be thrown by the implement).
  - Protect hoses from sharp bends, twisting, or flexing over short distances and normal implement operation.
  - Ensure sufficient length for free movement of the implement during normal operation and prevent pulling, pinching, catching, or rubbing, especially in articulation and pivot points. Clamp hoses securely to force controlled movement of the hose.
  - Avoid abrasive surfaces and sharp edges such as sheared or flame cut corners, fastener threads or cap screw heads, hose clamp ends, etc.
  - Avoid areas where the operator or service personnel might step or use as a grab bar.
- Do not connect, affix, or allow hoses to come into contact with components with high vibration forces, hot surfaces, or components carrying hot fluids beyond the temperature rating of hose components.
  - Hoses should be protected or shielded if routing requires the hose to be exposed to conditions beyond hose component specifications.
- Avoid routing hoses in areas where damage may occur due to build up of material (e.g. dirt, mud, snow, ice, etc.).

## Harness Routing

The word "harness" is used to describe any electrical cables and leads, both bundled and unbundled. Use the following guidelines and recommendations when connecting and routing harnesses while installing or maintaining this Raven system:

- Leave protective caps/covers over harness connectors until needed to avoid dirt and moisture from contaminating electrical circuits.
- Secure the harness to the frame or solid structural members at least every 12 in [30 cm].
- Follow existing harness runs already routed on the implement as much as possible. Proper harness routing should:
  - Secure harnessing and prevent the harness from hanging below the implement.
  - Provide sufficient clearance from moving components and operational zones around shafts; universal joints and suspension components; pulleys, gears, belts, and chains; moving linkages, cylinders, articulation joints, etc.
  - Protect harnessing from field debris and surrounding hazards (e.g. tree limbs, fence posts, crop stubble, dirt clumps or rocks that may fall or be thrown by the implement).
  - Protect harnessing from sharp bends, twisting, or flexing over short distances and normal implement operation.
  - Connectors and splices should not be located at bending points or in harness sections that move.
  - Ensure sufficient length for free movement of the implement during normal operation and prevent pulling, pinching, catching, or rubbing, especially in articulation and pivot points. Clamp harnessing securely to force controlled movement of the harness.
  - Avoid abrasive surfaces and sharp edges such as sheared or flame cut corners, fastener threads or cap screw heads, hose clamp ends, etc.
- Do not connect, affix, or allow harnessing to come into contact with components with high vibration forces, hot surfaces, or components carrying hot fluids beyond the temperature rating of harness components.
  - Harnessing should be protected or shielded if routing requires the hose to be exposed to conditions beyond harnessing component specifications.
- Avoid routing harnesses in areas where damage may occur due to build up of material (e.g. dirt, mud, snow, ice, etc.).

- Avoid routing harnesses in areas where the operator or service personnel might step or use as a grab bar.

**Note:** *Avoid applying direct spray or pressure washing of electrical components and connections. High pressure streams and sprays can penetrate seals, cause corrosion, or otherwise damage electrical components. When performing maintenance:*

- Inspect electrical components and connectors for corrosion, damaged pins or housings, etc. Repair or replace components or harnessing as necessary.
- Ensure connectors are kept clean and dry. Apply dielectric grease to the sealing surfaces of all connections exposed to moisture, dirt, debris, and other contaminants. Repair or replace harnessing as necessary.
- Clean electrical components with pressurized air, aerosol electrical cleaning agent, or low pressure rinse.
- Remove visible surface water from electrical components and connections using pressurized air or an aerosol cleaning agent. Allow components to dry thoroughly before reconnecting cables.



## Chapter 2:

### Introduction

#### NOTICE



Depending upon the make and model of the machine, the steps required to complete the installation of the RS1™/SC1™ with DirecSteer auto-steer system may differ from the instructions provided in the following procedure.

The DirecSteer steering system is designed to provide automated steering of agricultural equipment using an electric drive unit mounted to the steering column.

The instructions in this manual are intended to help with installation of the DirecSteer steering system on the following machines.

Brand	Type	Models
Case IH	Tractor	<ul style="list-style-type: none"> <li>Magnum 180, 190, 210, 215, 225, 235, 245, 260, 275, 290, 305, 315, 335, 340</li> <li>MX 180, 200, 210, 215, 230, 240, 245, 255, 270, 275, 285</li> </ul>
	Articulated Tracked Tractor	<ul style="list-style-type: none"> <li>Quadtrac 385, 435, 450, 485, 500, 535, 550, 600</li> <li>STX Quadtrac 375, 425, 450, 500</li> </ul>
	Articulated Tractor	<ul style="list-style-type: none"> <li>Steiger 330, 335, 350, 385, 400, 435, 450, 485, 500, 535, 550, 600</li> <li>STX 275, 280, 325, 330, 375, 380, 425, 430, 440, 450, 480, 500, 530</li> </ul>

Brand	Type	Models
New Holland	Tractor	<ul style="list-style-type: none"><li>• T8.275, 300, 330, 360, 390</li><li>• T8010, T8020, T8030, T8040, T8050</li><li>• TG 210, 215, 230, 245, 255, 275, 285, 305</li></ul>
	Articulated Tractor	<ul style="list-style-type: none"><li>• T9.390, 450, 505, 560, 615</li><li>• T9020, T9030, T9040, T9050, T9060</li><li>• TJ 275, 325, 375, 425, 440, 450, 500, 530</li></ul>

To be compatible with the kit provided and the instructions in this manual, the above makes and models must have the steering column shown below. This manual and the kit for which it is written are only compatible with this specific steering column.







## Kit Contents

This section contains a list of the components that are included in the kit. Before beginning the installation, compare the items in the kit with the components on this list. If you have questions about the kit, contact a local Raven dealer.

DirecSteer Steering Installation for Case IH Magnum, MX, Steiger, STX, & New Holland T8, T80XX, TG, T9, T90XX TJ (P/N 117-5030-402 Rev. C)

QTY	PART #	DESCRIPTION
1	BOX	BOX, SHIPPING, TBD BY MFG
1	116-4050-051	WELDMENT, CCH, FLANGED COLUMN CLAMP
1	063-4001-098	ASSEMBLY, 80mm, ANTIROTATION STEM
1	116-4050-014	WELDMENT, GROMMET HOLDER, M8 X 90MM
1	107-4001-093	BRACKET, GENERIC, STEERING MOTOR CABLE ROUTING AID
1	107-4050-014	DD, SPLINE ADAPTER, Claas, 5/8", 36T, Tapered, 124mm
1	063-8000-149	MASTER SWITCH AUTO PILOT W/ADAPTER
1	063-0173-654	ROCKER SWITCH ASSEMBLY ENABLE, 2PIN (SMARTRAX)
1	115-7325-071	CABLE, OP. PRESENCE SWITCH, 12P DT TEE TO 2P DT, CNH LA
1	117-4001-050	KIT, TRACTOR SIDE, DISPLAY MOUNT
1	063-8000-125	MOUNT PLATE ASY, ANT. ROOF
1	115-7325-021	CABLE, DD STEER, W/SMART RELAY
1	115-4001-258	CBL MOD DD STEER MOTOR CONNECTION CABLE W/CAN TE
1	117-5001-056	KIT, ROOF, RS1, CNH, NON-STEER READY
1	117-5030-601	KIT, DIRECSTEER, NON-ADJUSTABLE STEERING COLUMN COV
1	ENVELOPE	ENVELOPE, PLASTIC, TBD BY MFG
1	315-0000-034	GROMMET, TYPE D, 10MM ID, 20MM OD, 16MM HOLE DIA.,
3	313-6000-025K	WASHER, DIN125, STEEL - M16, CLASS 2 COATING
6	311-4070-090K	SCREW, HEX SOCKET COUNTERSUNK, ISO 10642, M5X12, 8.8'
4	311-4035-002K	HEX BOLT, FLANGED, ISO 4162 - M5 X 0.8 X 12MM
2	313-6000-013K	WASHER, ISO 7089, M8, STEEL, ZINC PLATED, 96 HR+
1	313-6002-013K	WASHER, LARGE, DIN9021, STEEL - M8, CLASS 2 COATIN
1	311-4035-054K	HEX BOLT, FLANGED, ISO 4162 - M8 x 1.25 x 20mm
1	016-0171-649	QSG RAVEN HELP AND EXTENDED WARRANTY 8.5 X 11

DirecSteer Motor Kit (P/N 117-5030-318 Rev. A)

QTY	PART #	DESCRIPTION
1	053-0159-351	BOX, SHIPPING
1	063-4001-053	ASSEMBLY, DD STEER, NON-BRANDED

DirecSteer Motor Installation Assembly for Case IH Magnum, MX, Steiger, STX, & New Holland T8, T80XX, TG, T9, T90XX TJ (P/N 054-5030-402 Rev. B)

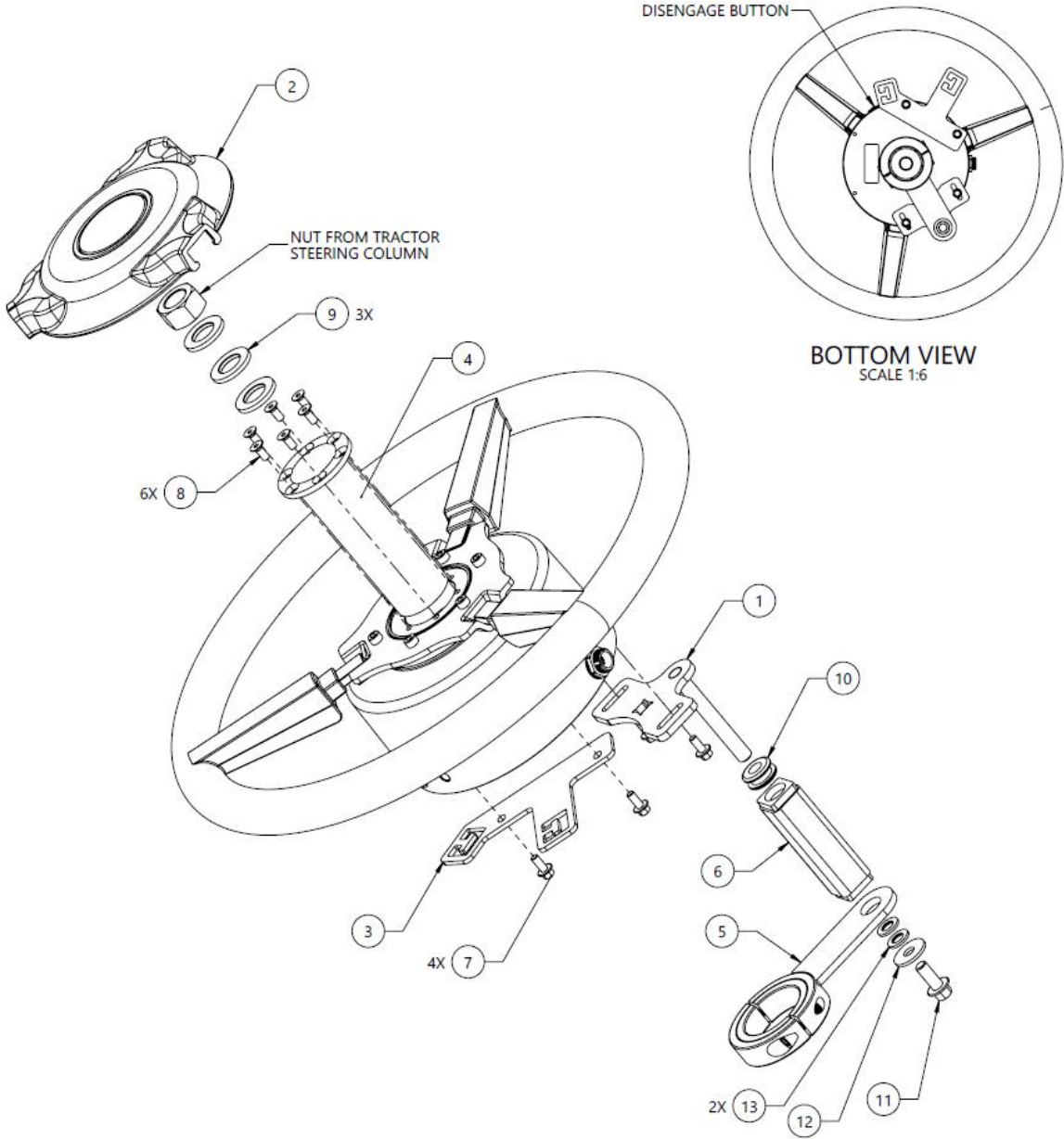

13	2	313-6000-013K	WASHER, ISO 7089, M8, STEEL, ZINC PLATED, 96 HR+
12	1	313-6002-013K	WASHER, LARGE, DIN 9201, M8, CARBON STEEL
11	1	311-4035-054K	FLANGED HEX BOLT, ISO 4162, M8-1.25 X 20MM, 8.8 STEEL
10	1	315-0000-034	GROMMET, TYPE D, 10MM ID, 20MM OD, 16MM HOLE DIA.
9	3	313-6000-025K	WASHER, ISO 7089, M16, STEEL, ZINC PLATED, 96 HR+
8	6	311-4070-090K	SCREW, HEX SOCKET FLAT HEAD, DIN 7991, M5-0.8 X 12MM, 8.8 STEEL
7	4	311-4035-002K	FLANGED HEX BOLT, ISO 4162, M5-0.8 X 12MM, 8.8 STEEL
6	1	116-4050-014	WELDMENT, GROMMET HOLDER, M8 X 90MM
5	1	116-4050-051	WELDMENT, CCH, FLANGED COLUMN CLAMP
4	1	107-4050-014	SPLINE ADAPTER, DIRECT DRIVE, 5/8", 36T, TAPERED, 124MM
3	1	107-4001-093	BRACKET, GENERIC, STEERING MOTOR CABLE ROUTING AID
2	1	106-0159-782	COVER, DIRECSTEER, RAVEN
1	1	063-4001-098	ASSEMBLY, 80MM, ANTI-ROTATION STEM
<b>ITM</b>	<b>QTY</b>	<b>PART NUMBER</b>	<b>DESCRIPTION</b>

## Specialized Tool Recommendations

The following tools are recommended for installation of the system:

- OTC 7403 steering wheel puller
- M5 x 0.8 x 100+ mm bolts (for DirecSteer motor removal)

## Updates

Software and manual updates are available on the Raven Applied Technology website.

<https://portal.ravenprecision.com>

Sign up for email alerts and you will be automatically notified when updates for Raven products are available.

At Raven Industries, we strive to make your experience with our Applied Technology products as rewarding as possible. One way to help us improve your experience is to provide your feedback.

Your feedback will help shape the future of our product documentation and the overall service we provide. We want to see ourselves as our customers see us and are eager to learn how we have been helping you or how we could do better.

To serve you best, please send an email with the following information to

[techwriting@ravenind.com](mailto:techwriting@ravenind.com)

- P/N 016-5030-402-B
- RS1™/SC1™ with DirecSteer Installation Manual for Case IH Magnum, MX, Steiger, STX, & New Holland T8, T80XX, TG, T9, T90XX TJ
- Any comments or feedback (please include URLs, chapter, or page numbers as applicable).
- Let us know how long have you been using this or other Raven products.

We will not share your email or any information you provide with anyone else. Your feedback is valued and extremely important to us.

We thank you for your time.



## Chapter 3:

# DirecSteer Installation

### NOTICE



Depending upon the make and model of the machine, the steps required to complete the installation of the RS1™/SC1™ with DirecSteer auto-steer system may differ from the instructions provided in the following procedure.

<a href="#">Prepare for the Installation</a> .....	19
<a href="#">Recommendations</a> .....	20
<a href="#">Point of Reference</a> .....	20
<a href="#">Remove the Steering Wheel</a> .....	21
<a href="#">Install the Anti-Rotation Brackets</a> .....	23
<a href="#">Install the DirecSteer Assembly</a> .....	27
<a href="#">Prepare the DirecSteer Assembly</a> .....	27
<a href="#">Attach Brackets to the Assembly</a> .....	28
<a href="#">Attach the DirecSteer Assembly to the Steering Column</a> .....	30
<a href="#">Remove the DirecSteer Assembly</a> .....	31

## Prepare for the Installation

Before installing the system, park the machine where the ground is level, clean, and dry. Leave the machine turned off for the duration of the installation process.

During the installation process, follow good safety practices. Be sure to carefully read the instructions in this manual as you complete the installation process.

## Recommendations

Raven Industries recommends the following best practices before installing or operating the system for the first time, at the start of the season, or when moving the system to another machine:

- Ensure the machine hydraulic filters have been recently changed and there are no issues with the machine hydraulic system (e.g., pump issues, faulty hydraulic motors, fine metal deposits in the hydraulic hoses, etc.).
- Operate each of the machine hydraulic functions (i.e., tilt, fold, center rack, tongue extension, or other hydraulic valve functions) three times to ensure the machine hydraulic valve is using fresh oil and debris is flushed from the hydraulic hoses, valves, and filters.
- Upon installation of the system, operate the hydraulic functions through the manual control functions first before operating hydraulic control via the controller/field computer to ensure the hydraulic system has been installed correctly and air is purged from the system.

Raven Industries recommends the following best practices when installing the system.

- Use part numbers to identify the parts.
- Do not remove the plastic wrap from a part until it is necessary for installation.
- Do not remove plastic caps from a part until it is necessary for installation.

## Point of Reference

The instructions in this documentation assume that you are standing behind the machine, looking toward the cab.



## Remove the Steering Wheel

1. Remove the cap from the center of the steering wheel.



2. Remove the nut used to secure the steering wheel to the column with a 22 mm socket.



3. Mount the OTC 7403 steering wheel puller on the steering wheel using the M8 - 1.25 x 90 bolts.



4. Remove the steering wheel.



**Note:** The factory steering wheel and components will not be used with the DirecSteer system. It is recommended to keep these components in case the DirecSteer system will be uninstalled or moved to a different machine.

## Install the Anti-Rotation Brackets

1. Collect the column clamp (P/N 116-4050-051), and two bolts included with the clamp.



2. Collect the grommet holder weldment (P/N 116-4050-014).



3. Place the grommet into the grommet holder.



4. Pull down the rubber boot around the steering column to allow access to the inner steering column.



5. Loosely attach the column clamp (P/N 116-4050-051) to the inner column with the flange closer to the top. Secure with the provided hardware, but do not tighten.



**Note:** The alignment of the column clamp may be further adjusted during installation. It is recommended to **not** tighten the hardware at this time.

6. Collect the grommet holder weldment (P/N 116-4050-014), M8 bolt (P/N 311-4035-054K), two standard M8 washers (P/N 313-6000-013K), and the large M8 washer (P/N 313-6002-013K).



7. Use the M8 bolt and washers to attach the grommet holder to the flanged column clamp.



# Install the DirecSteer Assembly

## Prepare the DirecSteer Assembly

1. Install the spline adapter (P/N 107-4050-014) into the center of the DirecSteer assembly (P/N 063-4001-053) and secure using the six provided M5 x 12 countersunk bolts (P/N 311-4070-090K).



2. Install the blue auxiliary motor disengage button (P/N 107-0172-837) by firmly pressing it into the mating port on the side of the DirecSteer assembly.



3. Turn the DirecSteer assembly upside down so the bottom is facing up.
4. Orientate the DirecSteer assembly so that the cable connector is at the 12 o'clock position.

## Attach Brackets to the Assembly

1. Collect the anti-rotation stem (P/N 063-4001-098), cable routing bracket (P/N 107-4001-093), and four M5 bolts (P/N 311-4035-002K).



2. Attach the cable routing bracket (P/N 107-4001-093) to the DirecSteer assembly at the 10 o'clock position and tighten with two provided M5 x 12 bolts (P/N 311-4035-002K).





3. Attach the anti-rotation stem (P/N 063-4001-098) to the DirecSteer assembly at the 2 o'clock position with two of the provided bolts (P/N 311-4035-002K), but do not tighten.



**Note:** *The position of the anti-rotation stem may be further adjusted during installation. It is recommended to **not** tighten the bolts at this time.*

## Attach the DirecSteer Assembly to the Steering Column

1. Insert the anti-rotation stem (P/N 063-4001-098) through the grommet in the grommet holder (P/N 116-4050-014) while also mating the spline adapter (P/N 107-4050-014) to the steering column.



2. Place the previously removed nut that was securing the original steering wheel and the three included washers (P/N 313-6000-025K) on the threaded end of the steering column. Torque the nut to 50 N-m.
3. Install the cover over the center of the DirecSteer steering wheel.



4. Tighten all anti-rotation hardware and brackets as needed.

## Remove the DirecSteer Assembly

1. Remove the steering wheel cover(s).



2. Remove the column nut and washer.
3. Remove three of the spline adapter bolts.



4. Attach an OTC 7403 steering wheel puller with M5 x 0.8 x 100+ mm bolts to the DirecSteer assembly. Use the provided spacer (P/N 305-1001-011) to protect the telescoping stem when applicable.



5. Remove the DirecSteer assembly.

## Chapter 4:

# Install the Field Computer

Every DirecSteer kit includes a tractor side display mount solution. The following section is for the generic mounting solution (P/N 117-4001-050). If a better mounting solution is available the generic kit does not need to be used. This generic mounting scheme is compatible with square/rectangular bars up to 5 cm x 2.5 cm [2 in x 1 in] and rounds rails with a diameter of 1.25 cm to 3.8 cm [0.5 in to 1.5 in].

The following instructions are general recommendations when mounting a field computer using the generic solution.

1. Install the tractor side display mount on an accessible square bar, round bar, or bracket within the operator cabin utilizing one of the following orientations:
  - a. Use the provided M6 x 80 bolts and accompanying hardware to attach the display mount and back plate to a square bar.



- b. Use the appropriate U-bolt pair and hardware to attach the display mount to a round rail.

**Note:** A provided plastic holder can be inserted into the smaller U-bolt to allow for smaller rail applications.



- c. If provided with mounting bracket (P/N 107-8000-082) and the machine has a matching bolt pattern, the display mount can be attached to a cab post.



2. Place the square base over the mounting posts on the back of the console.

**Note:** *The ball on the square base is offset to provide additional clearance or mobility of the console. The base may be oriented with the ball toward either the top or bottom of the console as necessary or desired for the selected mounting position.*

3. Use the provided flat washers, lock washers and screws to secure the square base to the back of the console.
4. Place the RAM® socket arm onto the circular base or u-bolt pipe clamp and tighten the arm to secure the console.
5. Adjust the console as necessary for optimal viewing and operation.

**Note:** *It is normal for the display case to become warm to the touch during operation.*





## Chapter 5:

# Assemble the Antenna Receiver

The DirecSteer system can function with either an RS1™ receiver or with a combination of a 500S™ receiver and SC1™ ECU node.

Refer to the most applicable section for the desired receiver:

---

<a href="#">Install the RS1™ to Bracket</a> .....	37
<a href="#">Insert a SIM Card in the RS1™</a> .....	37
<a href="#">Attach RS1™ to the Mounting Bracket</a> .....	38
<a href="#">Install the SC1™/TC1™ and 500S™ to Bracket</a> .....	38

## Install the RS1™ to Bracket

**Note:** Contact an authorized dealer for assistance with ordering or installing the RS1™ mounting kit for a specific machine.

### Insert a SIM Card in the RS1™

A SIM card is required for the RS1™ when using RTK subscriptions or remote support.

**Note:** Install a SIM card without a SIM pin code, or ensure the SIM pin code is switched off.

To install a SIM card in the RS1™:

1. Remove the four screws on the bottom of the RS1™.
2. Remove the SIM slot cover.

3. Insert the SIM card into the SIM slot.



**Note:** The SIM card must be inserted into the J11 slot or the RS1™ will not connect to wireless or a CORS network.

## Attach RS1™ to the Mounting Bracket

1. Use the 1/4" - 20 countersunk screws (P/N 311-0003-041) to secure the RS1™ bottom bracket (P/N 107-0172-498) to the RS1™.



## Install the SC1™/TC1™ and 500S™ to Bracket

1. Feed the circular 12-pin connector from the 500S™/SC1™ cable (P/N 115-0172-684) through the cutout on the top of the weldment.

2. Attach the bulkhead connector to the roof bracket (P/N 116-4001-001) with the two self-tapping 4.8 x 13 mm screws (P/N 310-4050-034) using a T25 Torx head screwdriver.



3. Connect the 12-pin circular connector to the 500S™ receiver (P/N 063-2000-006/-013).



**Note:** It is easier to attach the connector before the antenna is attached to the roof bracket.

4. Attach the 500S™ receiver to the roof bracket with the provided four #8-32 pan head screws (P/N 311-0005-243) and #8 washers (P/N 313-2301-807) using a T20 screwdriver.



5. Connect the 12-pin DTM plugs on the 500S™/SC1™ cable to the mating connectors on the SC1™/TC1™ unit.

**Note:** *It is easier to attach the connectors before the SC1™/TC1™ unit is attached to the roof bracket.*

6. Attach the SC1™ (P/N 063-0173-990) or TC1™ (P/N 063-0174-070) to the roof bracket with the provided two M6 x 30 countersink screws (P/N 311-4073-138), M6 Nylock nuts (P/N 312-6001-019), and M6 washers (P/N 313-6000-011) using a 10 mm wrench or socket and 4 mm hex key.



7. Attach the roof bracket (P/N 116-4001-001) to the RS1™ fixed mount bracket (P/N 107-0172-498) with the provided four M6 x 16 countersink screws (P/N 311-4073-134) using a 4 mm hex key.

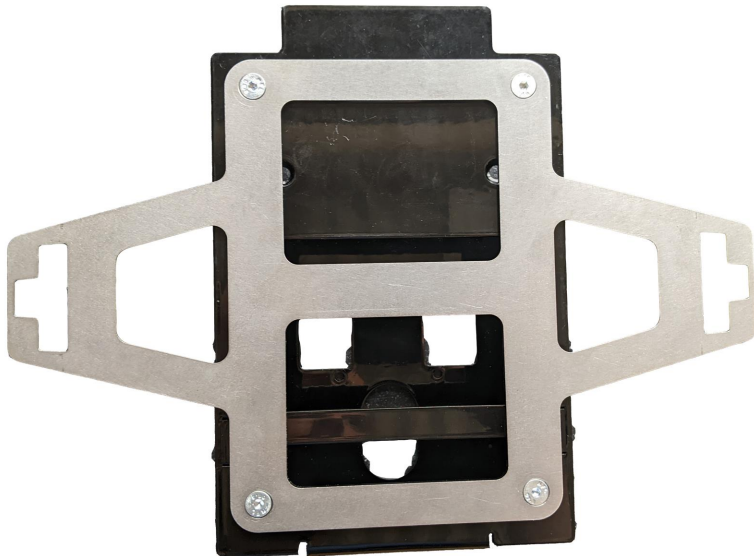



## Chapter 6:

# Install the Antenna Receiver

---

The DirecSteer system can function with either an RS1™ receiver or with a combination of a 500S™ receiver and SC1™ ECU node.

The following sections provide information on DirecSteer antenna mounting and is applicable to both antenna receiver solutions. Once assembled to the mounting hardware, both RS1™ and 500S™/SC1™ are mounted to the roof of the machine in the same way.

Refer to the most applicable section for the desired mounting method:

---

<a href="#">Mount with Adhesive Bracket</a> .....	43
<a href="#">Mount Antenna Receiver to Roof</a> .....	47

## Mount with Adhesive Bracket

1. Gather the receiver bracket, adhesive pads, and the accompanying hardware.



2. Attach the adhesive pads to the receiver bracket in the orientation shown.

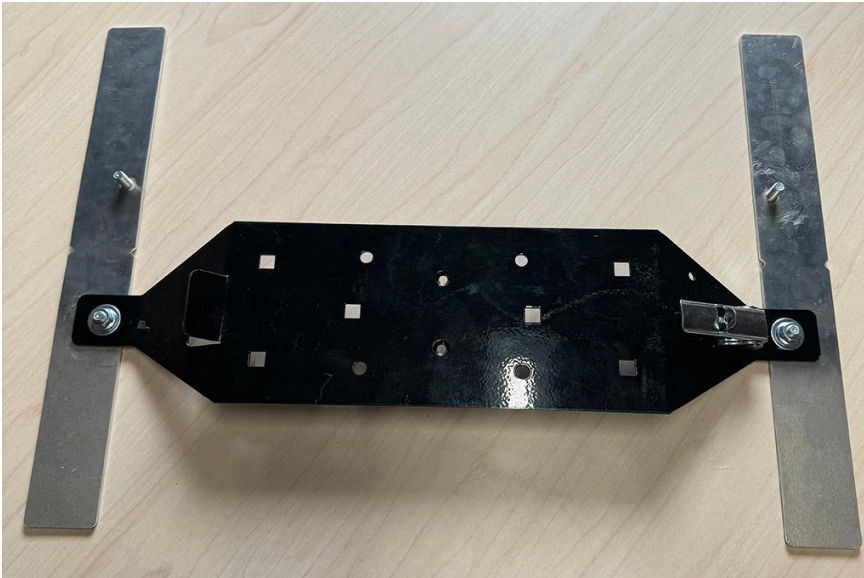

3. Select a location on the cab roof to mount the antenna receiver. Consider all of the following mounting requirements for best functionality of the antenna receiver:
  - The antenna receiver must be mounted at least 50 cm [20 in] from other GNSS, cellular, or radio antennas or equipment.
  - Align the antenna receiver on the center line of the tractor in front of the rear axle or toward the front of the cab.
  - The antenna receiver is mounted with the connectors facing toward the rear of the tractor.
4. Thoroughly clean the selected location.



5. Use the four adhesive pads to secure the receiver bracket assembly to the roof of the tractor.



6. Attach and secure the antenna receiver onto the receiver bracket so that the antenna receiver is facing the front of the machine.



7. If applicable, mount the round adhesive plate for the LAIRD cellular antenna (P/N 121-0000-042) within 50 cm [20 in] from the antenna receiver bracket.

**Note:** *The LAIRD antenna is the main cellular antenna for the RS1™. A minimum clearance of 1 m [39 in] is recommended around the antennas to help avoid common issues with signal interference.*

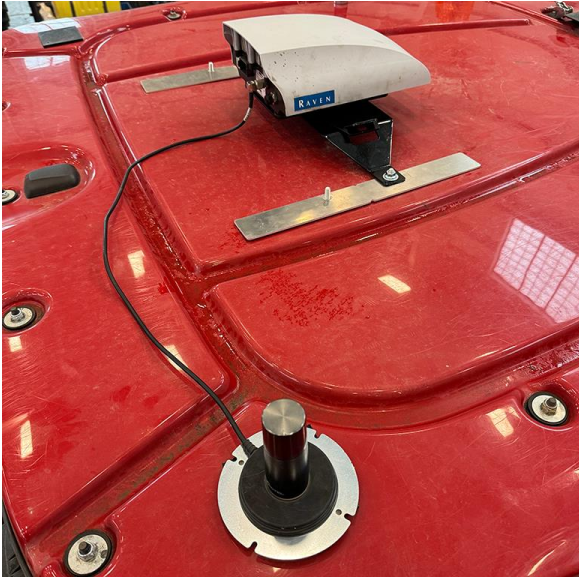

## Mount Antenna Receiver to Roof

1. Install the receiver mounting bracket to the roof of the machine using the two existing bolts.



2. Attach the antenna receiver to the mounting bracket so that the front of the antenna is pointing to the front of the machine. Secure the antenna to the bracket with the latch.



3. If applicable, mount the round adhesive plate for the LAIRD cellular antenna (P/N 121-0000-042) within 50 cm [20 in] from the antenna receiver bracket.

**Note:** *The LAIRD antenna is the main cellular antenna for the RS1™. A minimum clearance of 1 m [39 in] is recommended around the antennas to help avoid common issues with signal interference.*

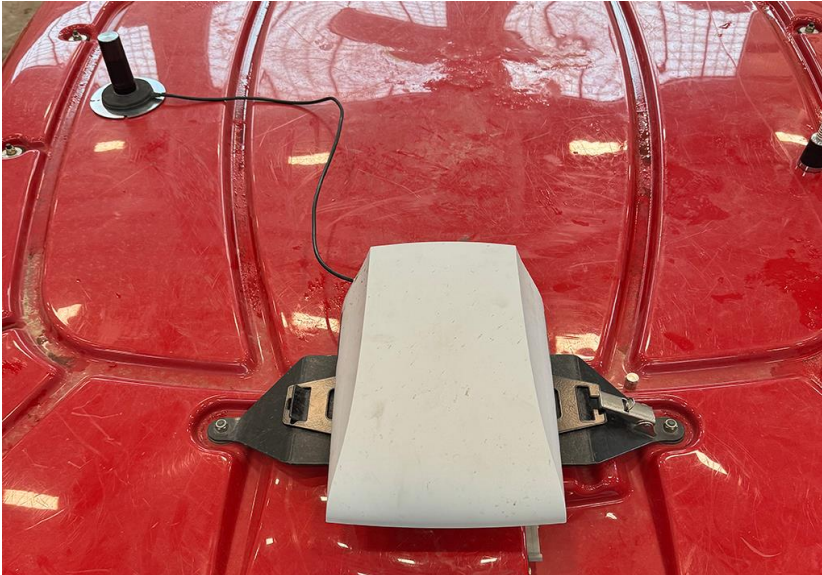

# Chapter 7:

## Cable Routing

### CAUTION

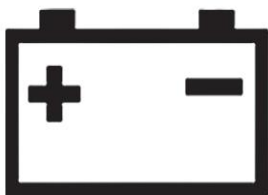

Do not connect the system power cable to the vehicle ignition or battery until all system components are mounted and all electrical connections are completed.

When installing an auto-steer system, the power cables should always be connected to the battery after all cables have been routed and connected. Two options are available:

- Implement Ready Power Harness (P/N 115-7325-012/013) with a ISObus IBBC connector
- Basic Power Harness (P/N 115-7325-001/002)

The Implement Ready Power Harness is the only harness with the ISObus IBBC connector, and should be mounted on the back of the tractor.

<a href="#">DirecSteer System Diagrams</a> .....	49
<a href="#">Best Routing Practices</a> .....	50
<a href="#">Route the DirecSteer Cables</a> .....	51
<a href="#">Connect to Power</a> .....	57

## DirecSteer System Diagrams

The following section contains a diagram of various systems which may interface with the auto-steer system.

## DirecSteer System Diagram (P/N 054-7325-001 Rev. B)

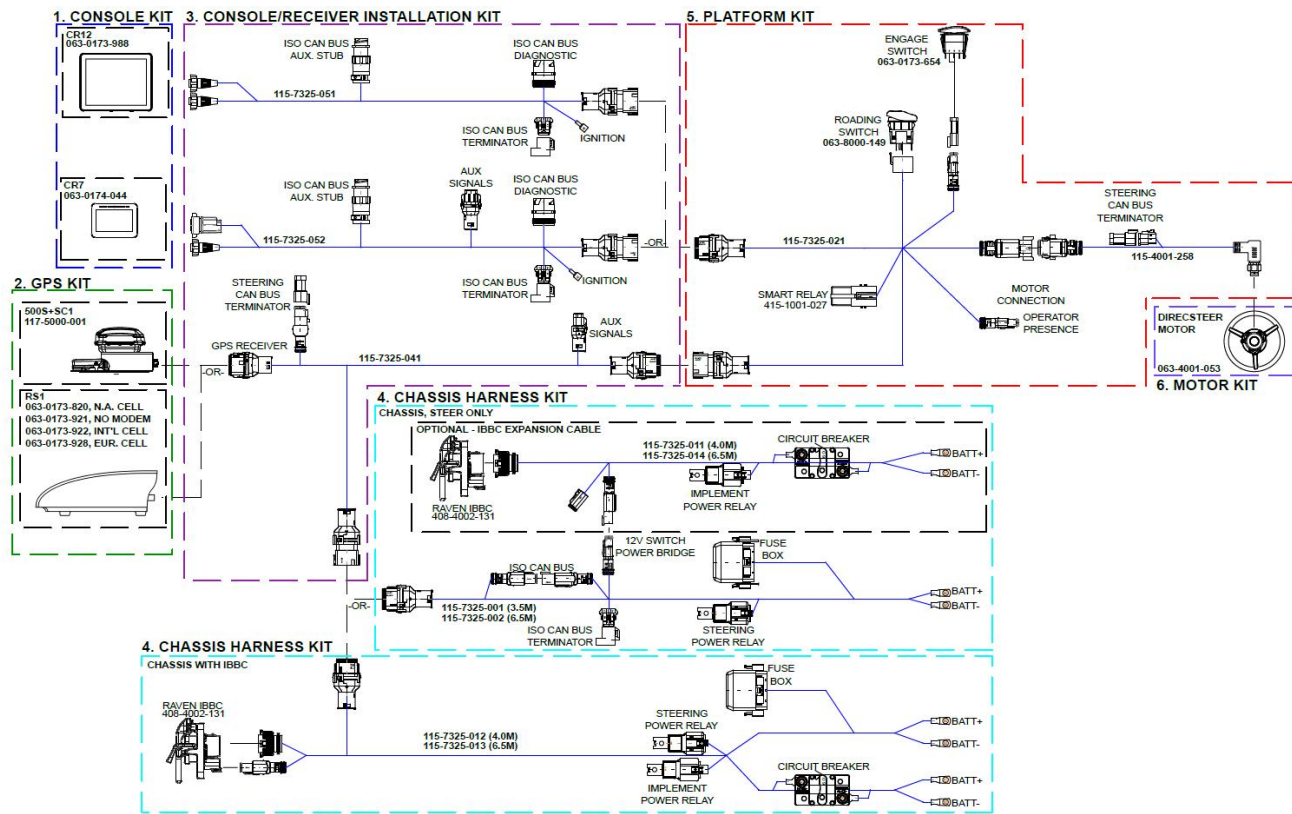

## Best Routing Practices

Ensure the installer follows all of the following guidelines for best routing practices:

- Mount the relays in fixed position on a clean, dry, easily accessible spot.
- The red wire is positive (12V). The black wire is negative (ground). Ensure that the first part of the red wire cannot be damaged during relay operation.
- Do not tie down the extra length between the battery and the fuses, but ensure the cable is an appropriate length. Be sure to use cable sockets with the correct size for proper connection.
- If a ground switch is used in the tractor, connect the wiring harness behind the ground switch, not at the battery side of the ground switch.
- If a main (12V) switch is used in the tractor, connect the red wire to the wiring harness behind the main switch, not at the battery side of the main switch.
- If no main switch is used, always connect the wiring harness directly to the battery.

- If the system is connected to a 24V machine, always use a 24V to 12V converter. Never connect between the two batteries of a 24V machine.
- Tie down the harnesses so they are free from vibration and friction.



## Route the DirecSteer Cables

1. Locate the battery of the tractor, normally located on the right side of the tractor, below the door/window.

**Note:** Do not connect any cables directly to the battery at this time.

2. If installing a kit with an IBBC:
  - a. Starting from the battery, route the implement ready power harness (P/N 115-7325-012/013) through the machine so the IBBC connectors end up near the back of the machine.
  - b. At the back of the machine, find the most appropriate mounting position for the IBBC connector. Be careful to consider moving parts or pinch points.
  - c. Attach the IBBC connector (P/N 408-4002-131) to the supplied mounting plate (P/N 107-8000-033).

- d. Mount the IBBC plate and connector to the back of the machine.



- e. Connect the ISOBUS IBBC connector from the DirecSteer power harness (P/N 115-7325-012/013) to mounted IBBC connector.

**If installing a kit without IBBC:**

- a. Starting from the battery, route the basic power harness (P/N 115-7325-001/002) to a point behind the cabin of the tractor.

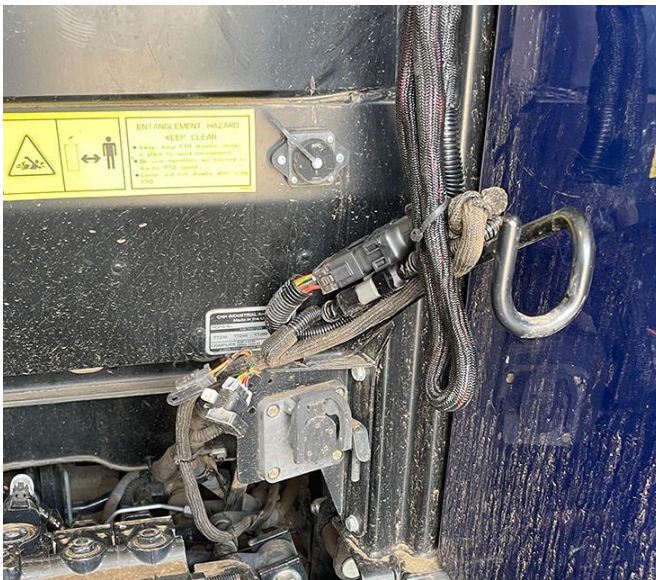

3. Attach the receiver tee cable (P/N 115-7325-041) to the previously routed 18-pin connector on the battery cable (P/N 115-7325-001/012).
4. Route the 18-pin connector on the RS1™ tee cable (P/N 115-7325-041) into the cabin through the cable transfer port on the machine.



5. Install the black 12-pin connector of the receiver tee cable (P/N 115-7325-041) to the port on the back of the RS1™ or 500S™/SC1™ mounting bracket.



6. In the cab, connect the 18-pin connector of the receiver tee (P/N 115-7325-041) to the mating connector of the DirecSteer cabin harness (P/N 115-7325-021).
7. Locate an open or free console cavity for the master switch and remove the blank.
8. Route the road switch connector from the DirecSteer cabin cable (P/N 115-7325-021) through the open cavity and connect it to the master switch.



9. Press the switch assembly into the cavity to seat the switch.



**Note:** If needed, use the supplied switch adapter (P/N 412-8000-037) when installing in a larger sized cavity.

10. Add the enable switch assembly (P/N 063-0173-654) on the cabin cable (P/N 115-7325-021).
11. Attach the seat switch tee (P/N 115-7325-071) to the 2-pin operator presence connector on the cabin cable (P/N 115-7325-021) and tee into the 12-pin seat cable (circled below).

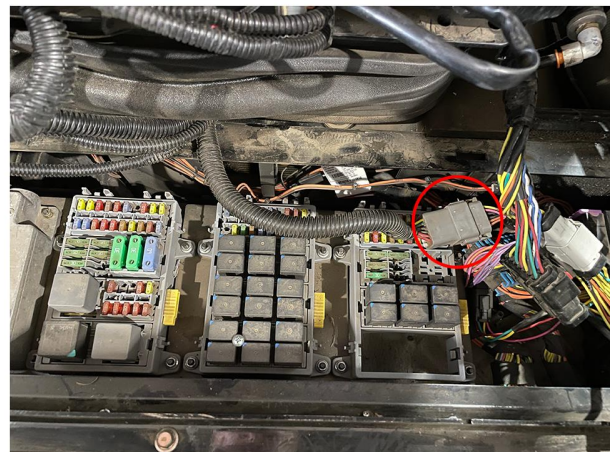

12. Connect motor cable (P/N 115-4001-258) to the electrical port on the DirecSteer assembly.



13. Route the DirecSteer motor cable (P/N 115-4001-258) along the wire routing bracket. Zip-tie the cabling as desired.



14. Route the 8-pin connector of the DirecSteer motor cable (P/N 115-4001-258) to the mating connector labeled "DirecSteer Motor Cable" on the DirecSteer main cable (P/N 115-7325-021).



15. Connect the 18-pin connector of the field computer harness (P/N 115-7325-051/052) to the mating connector of the receiver tee cable (P/N 115-7325-021).

16. Connect the field computer cable to the mating connectors on the back of the display.

**Note:** Refer to <https://ravenindustries.mcoutput.com/fieldcomp/Default.htm> for more detailed information on Raven field computers.



17. Once everything is installed and connected, hide the cabling behind the lining whenever possible, and tie down the cabling where appropriate to avoid loose cabling.

## Connect to Power

1. Locate the battery terminal rings on the DirecSteer power harness (P/N 115-7325-001/002 or -012/013).

2. Locate and open the battery compartment.



**Note:** Generally, the battery compartment is located on the right side of the tractor, in front of the rear tire and below or beside the tractor cab.

3. Route the black and red ring terminals from the power harness into the battery compartment.
4. Connect the red lead(s) to the positive battery terminal and the black lead(s) to the negative battery terminal.

