

# Raven RS1™/SC1™ with DirecSteer Installation Manual for Case IH Magnum and New Holland T8 PLM



Case IH / New Holland	
Magnum AFS Connect	180, 200, 220, 240, 250, 280, 310, 340, 380, 400, 340 Rowtrac, 380 Rowtrac, 400 Rowtrac
T8 PLM Intel- ligence	.320, .350, .380, .410, .435, .410 SmarTrax™, .435 SmarTrax™
T9 PLM Intel- ligence	.435 Wheeled, .480 Wheeled, .530 Wheeled and SmarTrax™, .565 Wheeled and SmarTrax™, .600 Wheeled and SmarTrax™, .645 Wheeled and SmarTrax™, .700 Wheeled and SmarTrax™
Steiger AFS Connect	370 Wheeled, 420 Wheeled and Rotrac, 470 Wheeled Rotrac and Quadtrac, 500 Wheeled Rotrac and Quadtrac, 540 Wheeled and Quadtrac, 580 Wheeled and Quadtrac, 620 Wheeled and Quadtrac
Quadtrac AFS Connect	400 Wheeled, 450 Wheeled and Quadtrac, 500 Wheeled and Quadtrac, 550 Wheeled and Quadtrac, 600 Wheeled and Quadtrac

P/N 016-5030-326-A Jun 2023 E45581

Copyright © 2023

---

# Disclaimer

---

While every effort has been made to ensure the accuracy of the information presented on this site, Raven Industries assumes no responsibility for omissions and errors. Nor is any liability assumed for damages resulting from the use of information contained herein.

Raven Industries shall not be responsible or liable for incidental or consequential damages or a loss of anticipated benefits or profits, work stoppage or loss, or impairment of data arising out of the use, or inability to use, this system or any of its components. Raven Industries shall not be held responsible for any modifications or repairs made outside our facilities, nor damages resulting from inadequate maintenance of this system.

As with all wireless and satellite signals, several factors may affect the availability and accuracy of wireless and satellite navigation and correction services (e.g. GPS, GNSS, SBAS, etc.). Therefore, Raven Industries cannot guarantee the accuracy, integrity, continuity, or availability of these services and cannot guarantee the ability to use Raven systems, or products used as components of systems, which rely upon the reception of these signals or availability of these services. Raven Industries accepts no responsibility for the use of any of these signals or services for other than the stated purpose.

---

# Table of Contents

---

<b>Disclaimer</b> .....	<b>a</b>
<b>Table of Contents</b> .....	<b>i</b>
<b>Important Safety Information</b> .....	<b>1</b>
Field Computers, Displays, and Control Consoles .....	2
Hydraulic Safety .....	2
Electrical Safety .....	3
Touch Screen .....	4
Recommendations and Best Practices .....	5
Point of Reference .....	5
Preparing for Install .....	5
Aerials and Signal Interference .....	5
Hose Routing .....	6
Harness Routing .....	7
<b>Introduction</b> .....	<b>11</b>
Kit Contents .....	12
Updates .....	14
<b>Install the DirecSteer System</b> .....	<b>17</b>
Prepare for the Installation .....	17
Recommendations .....	17
Tools Needed .....	18
Point of Reference .....	18
Remove the Steering Wheel .....	19
Install the Anti-Rotation Bracket .....	21
Install the DirecSteer Assembly .....	27
Prepare the DirecSteer Assembly .....	27
Attach the DirecSteer Assembly to the Steering Column .....	29

---

<b>Install the DirecSteer System Components</b> .....	<b>31</b>
Mount the (Optional) Foot Switch .....	31
Install the Field Computer .....	32
<b>Install RS1™ with DirecSteer</b> .....	<b>35</b>
Install the RS1™ Unit .....	36
Insert a SIM Card in the RS1™ .....	36
Assemble the Mounting Brackets .....	37
Prepare the Roof .....	37
Connect RS1™ Cabling to DirecSteer .....	38
Best Mounting Practices .....	39
Route the RS1™ Cabling to DirecSteer .....	40
Connect to Power .....	48
RS1™ and DirecSteer System Diagrams .....	49
<b>Install SC1™/TC1™ with DirecSteer</b> .....	<b>55</b>
Install the SC1™/TC1™ Unit .....	56
Install the Antenna .....	58
Install the 500S™ Receiver .....	58
Install the 700S™ Receiver .....	59
Connect SC1™ Cabling to DirecSteer .....	59
Best Mounting Practices .....	60
Route the SC1™ Cabling to DirecSteer .....	61
Connect the 500S™/700S™ Antenna .....	69
Connect to Power .....	69
SC1™ and DirecSteer System Diagrams .....	71
<b>Limited and Extended Warranties</b> .....	<b>75</b>
Limited Warranty .....	75
What does this warranty cover? .....	75
How long is the coverage period? .....	75

---



---

---

How can I get service? .....	75
What will Raven Industries do? .....	75
What is not covered by this warranty? .....	75
Extended Warranty .....	76
What does this warranty cover? .....	76
Do I need to register my product to qualify for the extended warranty? .....	76
Where can I register my product for the extended warranty? .....	76
How long is the extended warranty coverage period? .....	77
How can I get service? .....	77
What will Raven Industries do? .....	77
What is not covered by this warranty? .....	77



# Chapter 1:

## Important Safety Information

---

### **NOTICE**

Follow the operation and safety instructions included with the implement and/or controller and read this manual carefully before installing, servicing, or operating this Raven system.

- Park the machine where the ground is level, clean, and dry.
- Bleed pressure from the hydraulic system and leave the machine turned off for the duration of the installation or maintenance process.

Follow the operation and safety instructions included with the implement and/or controller. Before installing or operating this Raven system, review and understand the information presented on this site.

- Failure to follow safety instructions may lead to equipment damage, personal injury, or death.
- Review equipment operation with your local dealer and follow all safety information presented on this site.
- Contact a local Raven dealer for assistance with any portion of the installation, service, or operation of Raven equipment.
- Follow all safety labels affixed to system components. Be sure to keep safety labels in good condition and replace any missing or damaged labels. Contact a local Raven dealer to obtain replacements for safety labels.

Observe the following safety measures when operating the implement after installing this Raven system:

- Do not operate this Raven system or any agricultural equipment while under the influence of alcohol or an illegal substance.

- Be alert and aware of surroundings while operating this Raven system.
  - Determine and remain a safe working distance from obstacles and bystanders. The operator is responsible for disabling the system when a safe working distance has diminished.
  - Do not operate the implement on any public road with this Raven system enabled.
  - Maintain control of the vehicle at all times during operation. For example,
    - Remain in the operator seat while the system is enabled and disable automated Raven controls before exiting the operator seat.
    - Maintain control of safety devices such as E-Stops at all times during operation.
  - Disable this Raven system prior to starting any maintenance work on the implement or components of this Raven system.
- Do not attempt to modify or lengthen any of the system control cables. Extension cables are available from a local Raven dealer.

### Field Computers, Displays, and Control Consoles

- If the display will not be used for an extended period, it is best to remove the display from the machine and store it in a climate controlled environment. This may help to extend the service life of electronic components.
- To prevent theft, secure the display and GNSS antenna when leaving the machine unattended.

### **WARNING**

### Hydraulic Safety

When installing or servicing a hydraulic system or hydraulic components, be aware that hydraulic fluid may be extremely hot and under high pressure. Caution must be exercised.

- Always wear appropriate personal protective equipment when installing or servicing hydraulic systems.
- Never attempt to open or work on a hydraulic system with the implement running.
- Always take care when servicing or opening a system that has been pressurized.

- The implement or machine must remain stationary and switched off with booms or implement sections unfolded and supported during installation or maintenance.
- Any work performed on the hydraulic system must be done in accordance with the machine manufacturer's approved maintenance instructions.
- Before installing hydraulic components, ensure there are no issues with the machine hydraulic system (e.g. pump issues, faulty hydraulic motors, fine metal deposits in the hydraulic lines, etc.).
- Take precautions to prevent foreign material or contaminants from being introduced into the implement hydraulic system. Contaminants that are able to bypass the hydraulic filtration system will reduce performance and may damage hydraulic components.
  - Verify that the hydraulic system is using fresh oil and the filters have been changed.
- Stand clear of the implement when starting the system for the first time after installing or servicing hydraulic components in case a hose has not been properly connected or tightened.

**⚠ CAUTION**

### Electrical Safety

- Always verify that power leads are connected to the correct polarity as marked. Reversing the power leads could cause severe damage to the Raven system or other components.
- To prevent personal injury or fire, replace defective or blown fuses with only fuses of the same type and amperage.
- Do not connect the system power cable to the vehicle ignition or battery until all system components are mounted and all electrical connections are completed.
- Always start the machine before initializing this Raven system to prevent power surges or peak voltage.
- To avoid tripping and entanglement hazards, route cables and harnesses away from walkways, steps, grab bars, and other areas used by the operator or service personnel when operating or servicing the equipment.

## Touch Screen

- Only touch the touch-screen with your finger or by using a special touch-screen stylus or pen. Operating the touch-screen with sharp objects may cause permanent damage to the screen.
- Only clean the screen using a damp cloth. Never use caustic or other aggressive substances.

## Recommendations and Best Practices

### Point of Reference

Instructions provided generally assume you are standing behind the machine facing toward the cab. More specific orientation may be provided as necessary to complete procedures.

### Preparing for Install

- Ensure there are no issues with the machine hydraulic system (e.g., pump issues, faulty hydraulic motors, fine metal deposits in the hydraulic hoses, etc.).
- Verify that the machine hydraulic system is using fresh oil and that the filters have been recently changed.
- Ensure there are no issues with the steering system (e.g., worn bushings, faulty tie rod ends, improperly adjusted steering components, etc.)

### Aerials and Signal Interference

Due to the relatively low broadcast power from satellites, all GNSS receivers and aerials tend to be susceptible to sources of signal noise and interference as compared to terrestrial signals (i.e. radio or cellular).

**Note:** *Poor GNSS signal reception may cause other systems which rely on GNSS solutions (e.g. auto-steer systems, rate control systems, etc.) to disengage or may cause undesired operation or results.*

The following recommendations are intended to provide an optimal environment for GNSS systems and provide the best up-time results, even as sources of interference may spike throughout the day.

- Mount GNSS antennas with a clear, unobstructed view of the sky.
  - A minimum clearance of 1 m [39 in] is recommended around the GNSS antenna to help avoid common issues with signal interference. Do not mount cellular, radio, or other GNSS antennas within this area.
  - Mount the GNSS antenna to the tallest point of the machine. Avoid mounting the antenna in a location where obstructions (e.g. bins/hoppers, cab roof lines, equipment frame or structural elements, etc.) may rise into the antenna view.

**Note:** *The antenna view typically starts 5° to 10° above horizontal from the base of the antenna and extends over the skyward face of the receiver/antenna.*
- GNSS is a line-of-sight system. A clear path must exist between the satellite and the GNSS antenna.
  - Obstructions such as buildings, tree branches and limbs, as well as components of the vehicle such as a fiberglass or metal roof, and etc. may cause signal multi-path or completely block the GNSS receiver.
- Electrical and magnetic fields can interfere with GNSS or L-Band signals.
  - Avoid mounting GNSS receivers or antennas near components such as radio or cellular antennas, electrical motors, generators, alternators, strobe lights, radio transmitters, radio or cellular antennas, etc.
  - Over-head power lines, microwave dishes, radar, other active antennas, etc. can interfere with GNSS signal.
- Mount the Field Hub cellular and diversity antennas at least 1 m [39 in] apart. Avoid mounting other cellular, radio, or GNSS aerials within this area.

### Hose Routing

The word “hose” is used to describe any flexible, fluid carrying components. Use the following guidelines and recommendations when connecting and routing hoses while installing or maintaining this Raven system:

- Leave protective caps/covers over hose ends until connecting the end into the hydraulic system to help prevent contaminants from entering the system.



- Follow existing hose runs already routed on the implement as much as possible.  
Proper hose routing should:
  - Secure hoses and prevent hoses from hanging below the implement.
  - Provide sufficient clearance from moving components and operational zones around shafts; universal joints and suspension components; pulleys, gears, belts, and chains; moving linkages, cylinders, articulation joints, etc.
  - Protect hoses from field debris and surrounding hazards (e.g. tree limbs, fence posts, crop stubble, dirt clumps or rocks that may fall or be thrown by the implement).
  - Protect hoses from sharp bends, twisting, or flexing over short distances and normal implement operation.
  - Ensure sufficient length for free movement of the implement during normal operation and prevent pulling, pinching, catching, or rubbing, especially in articulation and pivot points. Clamp hoses securely to force controlled movement of the hose.
  - Avoid abrasive surfaces and sharp edges such as sheared or flame cut corners, fastener threads or cap screw heads, hose clamp ends, etc.
  - Avoid areas where the operator or service personnel might step or use as a grab bar.
- Do not connect, affix, or allow hoses to come into contact with components with high vibration forces, hot surfaces, or components carrying hot fluids beyond the temperature rating of hose components.
  - Hoses should be protected or shielded if routing requires the hose to be exposed to conditions beyond hose component specifications.
- Avoid routing hoses in areas where damage may occur due to build up of material (e.g. dirt, mud, snow, ice, etc.).

## Harness Routing

The word "harness" is used to describe any electrical cables and leads, both bundled and unbundled. Use the following guidelines and recommendations when connecting and routing harnesses while installing or maintaining this Raven system:

- Leave protective caps/covers over harness connectors until needed to avoid dirt and moisture from contaminating electrical circuits.

- Secure the harness to the frame or solid structural members at least every 12 in [30 cm].
- Follow existing harness runs already routed on the implement as much as possible. Proper harness routing should:
  - Secure harnessing and prevent the harness from hanging below the implement.
  - Provide sufficient clearance from moving components and operational zones around shafts; universal joints and suspension components; pulleys, gears, belts, and chains; moving linkages, cylinders, articulation joints, etc.
  - Protect harnessing from field debris and surrounding hazards (e.g. tree limbs, fence posts, crop stubble, dirt clumps or rocks that may fall or be thrown by the implement).
  - Protect harnessing from sharp bends, twisting, or flexing over short distances and normal implement operation.
  - Connectors and splices should not be located at bending points or in harness sections that move.
  - Ensure sufficient length for free movement of the implement during normal operation and prevent pulling, pinching, catching, or rubbing, especially in articulation and pivot points. Clamp harnessing securely to force controlled movement of the harness.
  - Avoid abrasive surfaces and sharp edges such as sheared or flame cut corners, fastener threads or cap screw heads, hose clamp ends, etc.
- Do not connect, affix, or allow harnessing to come into contact with components with high vibration forces, hot surfaces, or components carrying hot fluids beyond the temperature rating of harness components.
  - Harnessing should be protected or shielded if routing requires the hose to be exposed to conditions beyond harnessing component specifications.
- Avoid routing harnesses in areas where damage may occur due to build up of material (e.g. dirt, mud, snow, ice, etc.).
- Avoid routing harnesses in areas where the operator or service personnel might step or use as a grab bar.

**Note:** Avoid applying direct spray or pressure washing of electrical components and connections. High pressure streams and sprays can penetrate seals, cause corrosion, or otherwise damage electrical components. When performing maintenance:

- Inspect electrical components and connectors for corrosion, damaged pins or housings, etc. Repair or replace components or harnessing as necessary.
- Ensure connectors are kept clean and dry. Apply dielectric grease to the sealing surfaces of all connections exposed to moisture, dirt, debris, and other contaminants. Repair or replace harnessing as necessary.
- Clean electrical components with pressurized air, aerosol electrical cleaning agent, or low pressure rinse.
- Remove visible surface water from electrical components and connections using pressurized air or an aerosol cleaning agent. Allow components to dry thoroughly before reconnecting cables.



## Chapter 2: Introduction

### NOTICE



Depending upon the make and model of the machine, the steps required to complete the installation of the RS1™/SC1™ with DirecSteer auto-steer system may differ from the instructions provided in the following procedure.

The DirecSteer steering system is designed to provide automated steering of agricultural equipment using an electric drive unit mounted to the steering column.

The instructions in this manual are intended to help with installation of the DirecSteer steering system on the following machines.

Case IH / New Holland	
Magnum AFS Connect	180, 200, 220, 240, 250, 280, 310, 340, 380, 400, 340 Rowtrac, 380 Rowtrac, 400 Rowtrac
T8 PLM Intelligence	.320, .350, .380, .410, .435, .410 SmarTrax™, .435 SmarTrax™
T9 PLM Intelligence	.435 Wheeled, .480 Wheeled, .530 Wheeled and SmarTrax™, .565 Wheeled and SmarTrax™, .600 Wheeled and SmarTrax™, .645 Wheeled and SmarTrax™, .700 Wheeled and SmarTrax™
Steiger AFS Connect	370 Wheeled, 420 Wheeled and Rotrac, 470 Wheeled Rotrac and Quadtrac, 500 Wheeled Rotrac and Quadtrac, 540 Wheeled and Quadtrac, 580 Wheeled and Quadtrac, 620 Wheeled and Quadtrac
Quadtrac AFS Connect	400 Wheeled, 450 Wheeled and Quadtrac, 500 Wheeled and Quadtrac, 550 Wheeled and Quadtrac, 600 Wheeled and Quadtrac

To be compatible with the kit provided and the instructions in this manual, the above makes and models must have the steering column shown below. This manual and the kit for which it is written are only compatible with this specific steering column.



## Kit Contents

This section contains a list of the components that are included in the kit. Before beginning the installation, compare the items in the kit with the components on this list. If you have questions about the kit, contact a local Raven dealer.

DirecSteer Steering Installation Kit for Case IH Magnum/Steiger and New Holland T8/T9 (P/N 117-5030-326 Rev. A)

QTY	PART #	DESCRIPTION
1	053-0159-321	BOX BRN SNGL 10KG 200X140X140
1	116-4050-021	BRACKET, DD, ANTI-ROTATION, GENERIC, MEDIUM
1	107-4050-135	BRACKET, ANTI-ROTATION, GENERIC CLAMP
1	107-4050-102	PIN, ANTI-ROTATION, 100MM
1	107-4050-014	DD, SPLINE ADAPTER, Claas, 5/8", 36T, Tapered, 124mm
1	053-0159-385	ENVELOPE, PLASTIC
6	311-4070-090K	SCREW, HEX SOCKET COUNTERSUNK, ISO 10642, M5X12, 8.8,
2	311-4060-136K	SCREW, HEXAGON SOCKET CAP, DIN912, 8.8, M6X20
2	311-4060-093K	SCREW, HEXAGON SOCKET CAP, DIN912, 8.8, M5X20
2	312-6001-012K	HEX LOCK NUT, NYLON INSERT, DIN985, CLASS 8, M5X0.8, ZIN
4	313-6000-007K	WASHER, ZINK, DIN125A, M5
4	313-6000-025K	WASHER, ZINK, DIN125A, M16
1	325-0000-048	BEARING, PLASTIC 12mm, FLANGED
1	016-0171-649	SHEET, WARRANTY/HELP

## DirecSteer Steering Installation Kit with SC1™ and w/o IBBC (P/N 117-5030-310 Rev. A)

<b>QTY</b>	<b>PART #</b>	<b>DESCRIPTION</b>
1	053-0159-321	BOX BRN SNGL 10KG 200X140X140
1	063-0174-070	ECU, ISO, TC1, LOW SPEED STEERING
1	115-8000-474	CABLE, DD STEER, V2.1
1	115-8000-475	HARNESS. IN-CAB, SC1, W/ CAN2
1	115-8000-141	HARNESS, POWER, BASIC
1	115-8000-473	CABLE, DD STEER POWER, 2.5M
1	117-8000-255	KIT, BRACKET, NODE, SEAT MOUNT
1	063-2000-010	ASSEMBLY, 700S, MACHINE BRACKET
1	117-8000-341	KIT, MOUNTING, TRACTOR
1	115-8000-214	HARNESS, CHASSIS, EXTENSION, 2M
1	115-4001-257	CABLE, DD STEER, MOTOR CONNECTION
1	063-8000-149	MASTER SWITCH AUTO PILOT W/ ADAPTER

## DirecSteer Steering Installation Kit with SC1™ and IBBC (P/N 117-5030-311 Rev. A)

<b>QTY</b>	<b>PART #</b>	<b>DESCRIPTION</b>
1	053-0159-321	BOX BRN SNGL 10KG 200X140X140
1	063-0174-070	ECU, ISO, TC1, LOW SPEED STEERING
1	115-8000-474	CABLE, DD STEER, V2.1
1	115-8000-475	HARNESS. IN-CAB, SC1, W/ CAN2
1	115-8000-315	HARNESS, POWER, IMPLEMENT READY, MID MOUNT BATTERY
1	107-8000-033	BRACKET, IBBC, IR
1	408-4002-131	CONNECTOR, RECEPTACLE PANEL MOUNT, POWELL IBBC
1	115-8000-473	CABLE, DD STEER POWER, 2.5M
1	117-8000-255	KIT, BRACKET, NODE, SEAT MOUNT
1	063-2000-010	ASSEMBLY, 700S, MACHINE BRACKET
1	117-8000-341	KIT, MOUNTING, TRACTOR
1	115-8000-214	HARNESS, CHASSIS, EXTENSION, 2M
1	115-4001-257	CABLE, DD STEER, MOTOR CONNECTION
1	063-8000-149	MASTER SWITCH AUTO PILOT W/ ADAPTER

## DirecSteer Steering Installation Kit with RS1™ and w/o IBBC (P/N 117-5030-312 Rev. A)

QTY	PART #	DESCRIPTION
1	053-0159-321	BOX BRN SNGL 10KG 200X140X140
1	115-8000-474	CABLE, DD STEER, V2.1
1	115-8000-141	HARNESS, POWER, BASIC
1	115-8000-473	CABLE, DD STEER POWER, 2.5M
1	117-5001-058	KIT, ROOF, RS1, STICK-ON
1	063-8000-125	MOUNT PLATE ASY, ANT. ROOF
1	117-8000-341	KIT, MOUNTING, TRACTOR
1	115-8000-214	HARNESS, CHASSIS, EXTENSION, 2M
1	115-4001-257	CABLE, DD STEER, MOTOR CONNECTION
1	063-8000-149	MASTER SWITCH AUTO PILOT W/ ADAPTER

## DirecSteer Steering Installation Kit with RS1™ and IBBC (P/N 117-5030-313 Rev. A)

QTY	PART #	DESCRIPTION
1	053-0159-321	BOX BRN SNGL 10KG 200X140X140
1	115-8000-474	CABLE, DD STEER, V2.1
1	115-8000-315	HARNESS, POWER, IMPLEMENT READY, MID MOUNT BATTERY
1	107-8000-033	BRACKET, IBBC, IR
1	408-4002-131	CONNECTOR, RECEPTACLE PANEL MOUNT, POWELL IBBC
1	115-8000-473	CABLE, DD STEER POWER, 2.5M
1	117-5001-058	KIT, ROOF, RS1, STICK-ON
1	063-8000-125	MOUNT PLATE ASY, ANT. ROOF
1	117-8000-341	KIT, MOUNTING, TRACTOR
1	115-8000-214	HARNESS, CHASSIS, EXTENSION, 2M
1	115-4001-257	CABLE, DD STEER, MOTOR CONNECTION
1	063-8000-149	MASTER SWITCH AUTO PILOT W/ ADAPTER

## DirecSteer Motor and Anti-Rotation Bracket Kit (P/N 117-5030-314 Rev. B)

QTY	PART #	DESCRIPTION
1	053-0159-351	BOX SHIPPING, W500 X D500 X H200
1	063-4001-040	ASSEMBLY, DD STEER, RAVEN
1	106-0159-781	COVER, DD STEER, RAVEN, ADJUSTABLE STEERING COLUMN
1	053-0159-374	GRIP-SEAL BAG, PE, 80 X 120
1	107-4050-104	DD STEER, ANTI-ROTATION BRACKET
2	311-4070-091K	SCREW, COUNTERSUNK, DIN7991 CLASS 8.8, M5X16

## Updates

Software and manual updates are available on the Raven Applied Technology website.



<https://portal.ravenprecision.com>

Sign up for email alerts and you will be automatically notified when updates for Raven products are available.

At Raven Industries, we strive to make your experience with our Applied Technology products as rewarding as possible. One way to help us improve your experience is to provide your feedback.

Your feedback will help shape the future of our product documentation and the overall service we provide. We want to see ourselves as our customers see us and are eager to learn how we have been helping you or how we could do better.

To serve you best, please send an email with the following information to [techwriting@ravenind.com](mailto:techwriting@ravenind.com)

- P/N 016-5030-326-A
- Raven RS1™/SC1™ with DirecSteer Installation Manual for Case IH Magnum and New Holland T8 PLM
- Any comments or feedback (please include URLs, chapter, or page numbers as applicable).
- Let us know how long have you been using this or other Raven products.

We will not share your email or any information you provide with anyone else. Your feedback is valued and extremely important to us.

We thank you for your time.



# Chapter 3:

## Install the DirecSteer System

### NOTICE



Depending upon the make and model of the machine, the steps required to complete the installation of the RS1™/SC1™ with DirecSteer auto-steer system may differ from the instructions provided in the following procedure.

<a href="#">Prepare for the Installation</a> .....	17
<a href="#">Recommendations</a> .....	17
<a href="#">Tools Needed</a> .....	18
<a href="#">Point of Reference</a> .....	18
<a href="#">Remove the Steering Wheel</a> .....	19
<a href="#">Install the Anti-Rotation Bracket</a> .....	21
<a href="#">Install the DirecSteer Assembly</a> .....	27
<a href="#">Prepare the DirecSteer Assembly</a> .....	27
<a href="#">Attach the DirecSteer Assembly to the Steering Column</a> .....	29

## Prepare for the Installation

Before installing the system, park the machine where the ground is level, clean, and dry. Leave the machine turned off for the duration of the installation process.

During the installation process, follow good safety practices. Be sure to carefully read the instructions in this manual as you complete the installation process.

### Recommendations

Raven Industries recommends the following best practices before installing or operating the system for the first time, at the start of the season, or when moving the system to another machine:

- Ensure the machine hydraulic filters have been recently changed and there are no issues with the machine hydraulic system (e.g., pump issues, faulty hydraulic motors, fine metal deposits in the hydraulic hoses, etc.).
- Operate each of the machine hydraulic functions (i.e., tilt, fold, center rack, tongue extension, or other hydraulic valve functions) three times to ensure the machine hydraulic valve is using fresh oil and debris is flushed from the hydraulic hoses, valves, and filters.
- Upon installation of the system, operate the hydraulic functions through the manual control functions first before operating hydraulic control via the controller/field computer to ensure the hydraulic system has been installed correctly and air is purged from the system.

Raven Industries recommends the following best practices when installing the system.

- Use part numbers to identify the parts.
- Do not remove the plastic wrap from a part until it is necessary for installation.
- Do not remove plastic caps from a part until it is necessary for installation.

### Tools Needed

The following tools are recommended for installation of the system:

- Steering wheel puller
- Standard-sized wrenches
- Cable ties
- Set of tools
- Fish tape (recommended)

### Point of Reference

The instructions in this documentation assume that you are standing behind the machine, looking toward the cab.

## Remove the Steering Wheel

### NOTICE

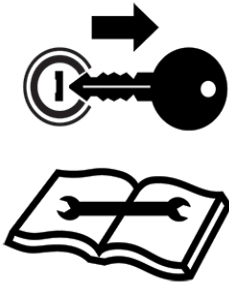

A steering wheel puller (not supplied) is required to complete the following procedure. Contact a local equipment dealer for assistance with any questions regarding the proper use of a steering wheel puller or removing the steering wheel.

1. Remove the cap from the center of the steering wheel.



2. Remove the nut used to secure the steering wheel to the column with a 22 mm socket.



3. Mount the steering wheel puller on the steering wheel. Insert M8 bolts in the holes made for pulling the steering wheel.



4. Remove the steering wheel.

## Install the Anti-Rotation Bracket

1. Remove the driver side cover with a T30 Torx key to reveal the bolts securing the window side cover.





2. Remove the two bolts on both sides of the steering column to take off the window side cover.





3. Remove the cover.



4. Cut a hole in the cover on market location. These measurements are an approximation. Bracket can be installed as seen in the steps below beforehand to make sure the measurements are correct.

**Note:** *The marks on this image are approximate and may not be to scale. Follow the distancing guidelines for best results.*

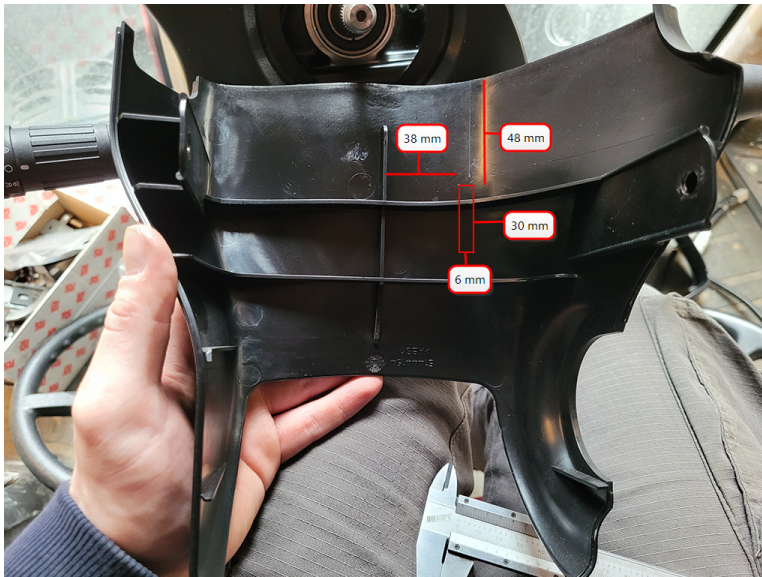

5. Remove the two bolts from the steering column that are going to be used for mounting the bracket. After taking these bolts out, insert the two M6x90 bolts through the holes with the hex head on the left side of the column and place the 25 mm spacers (P/N 305-1001-010) on the bolts.



6. After cutting the hole in the cover, stick the part of the bracket that is going to be mounted to the column, from the front of the cover, through the hole.



7. Insert the bolts back in through the mounting holes of the cover and tighten them.



8. Remount the driver-side cover.





9. Use two M5 bolts (P/N 311-4060-093), M5 washers (P/N 313-6000-007), and M5 nuts (P/N 312-6000-012) to mount the anti-rotation bearing (P/N 325-0000-048) to the bracket. Do not tighten the bolts yet to make the install of the DirecSteer system easier.



**Note:** *The factory steering wheel and components will not be used with the DirecSteer system. It is recommended to keep these components in case the DirecSteer system will be uninstalled or moved to a different machine.*

## Install the DirecSteer Assembly

### Prepare the DirecSteer Assembly

1. Use two M5x16 bolts (P/N 311-4070-091K) to secure the anti-rotation pin bracket (P/N 107-4050-104) to the bottom of the DirecSteer assembly (P/N 063-4001-040).

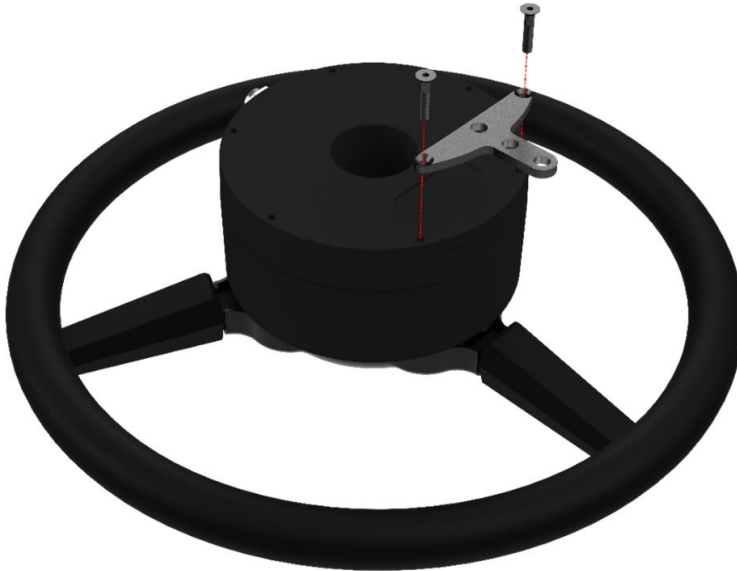

**Note:** The anti-rotation pin bracket may be secured using any two of the mounting threaded holes on the bottom of the DirecSteer casing. Determine the preferred wire harness position and orientation for the DirecSteer casing to select the position of the anti-rotation pin bracket.

When mounted, the anti-rotation pin bracket will be positioned facing the driver seat above the self-adjusting bearing and bracket.

2. By hand, remove the center cover from the DirecSteer assembly.



3. Install the spline adapter (P/N 107-4050-014) into the center of the DirecSteer assembly and secure using the six provided M5x12 bolts (P/N 311-4070-090).



## Attach the DirecSteer Assembly to the Steering Column

1. Place the DirecSteer steer wheel over the spline and insert the anti-rotation pin (P/N 107-4050-135) through the bearing.



2. Place the nut that was previously used to secure the original steering wheel in the spline adapter and tighten it down to secure the DirecSteer steering wheel to the steering column.



3. Install the cover over the center of the DirecSteer steering wheel.



4. Check that all hardware is properly tightened and the DirecSteer is secure.



## Chapter 4: Install the DirecSteer System Components

### NOTICE



Depending upon the make and model of the machine, the steps required to complete the installation of the RS1™/SC1™ with DirecSteer auto-steer system may differ from the instructions provided in the following procedure.

### Mount the (Optional) Foot Switch

### ⚠ CAUTION



Route cables to avoid creating a tripping hazard and away from possible damage due to pinch points, heat generating and moving components, etc.

1. Select a suitable location to mount the foot switch (P/N 063-0172-470) within easy reach of the operator seat.

2. Use the base plate of the foot switch as a template to drill holes for mounting the foot switch.



3. Secure the foot switch to the floor using the supplied screws through the base plate.

## Install the Field Computer

Several options exist for compatible displays for field computers for the DirecSteer system. The following instructions are general recommendations when mounting a field computer.

1. Loosen the RAM® socket arm and remove the circular base or pipe clamp.
2. Mount the circular base to a flat surface or to the u-bolt pipe clamp within the operator's cabin or compartment.
3. Place the square base over the mounting posts on the back of the console.  
***Note:** The ball on the square base is offset to provide additional clearance or mobility of the console. The base may be oriented with the ball toward either the top or bottom of the console as necessary or desired for the selected mounting position.*
4. Use the provided flat washers, lock washers and screws to secure the square base to the back of the console.
5. Replace the RAM® socket arm onto the circular base or u-bolt pipe clamp and tighten the arm to secure the console.
6. Adjust the console as necessary for optimal viewing and operation.

***Note:** It is normal for the display case to become warm to the touch during operation.*

7. Connect the power cable and any other necessary cabling to the connections on the back of the device.

**Note:** Refer to "Connect RS1™ Cabling to DirecSteer" on page 38 or "Connect SC1™ Cabling to DirecSteer" on page 59 for more detailed information on cable connections with DirecSteer.



# Chapter 5:

## Install RS1™ with DirecSteer

**Note:** This section only applies to DirecSteer kits with RS1™ guidance. For SC1™/TC1™ information, see "Install SC1™/TC1™ with DirecSteer" on page 55.

### CAUTION

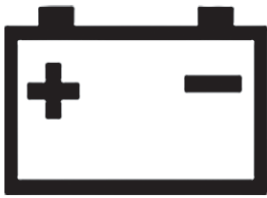

Do not connect the system power cable to the vehicle ignition or battery until all system components are mounted and all electrical connections are completed.

<a href="#">Install the RS1™ Unit</a> .....	36
<a href="#">Insert a SIM Card in the RS1™</a> .....	36
<a href="#">Assemble the Mounting Brackets</a> .....	37
<a href="#">Prepare the Roof</a> .....	37
<a href="#">Connect RS1™ Cabling to DirecSteer</a> .....	38
<a href="#">Best Mounting Practices</a> .....	39
<a href="#">Route the RS1™ Cabling to DirecSteer</a> .....	40
<a href="#">Connect to Power</a> .....	48
<a href="#">RS1™ and DirecSteer System Diagrams</a> .....	49

## Install the RS1™ Unit

### NOTICE



Depending upon the make and model of the machine, the steps required to complete the installation of the RS1™/SC1™ with DirecSteer auto-steer system may differ from the instructions provided in the following procedure.

**Note:** Contact an authorized dealer for assistance with ordering or installing the RS1™ mounting kit for a specific machine.

### Insert a SIM Card in the RS1™

A SIM card is required for the RS1™ when using RTK subscriptions or remote support.

**Note:** Install a SIM card without a SIM pin code, or ensure the SIM pin code is switched off.

To install a SIM card in the RS1™:

1. Remove the four screws on the bottom of the RS1™.
2. Remove the SIM slot cover.
3. Insert the SIM card into the SIM slot.



**Note:** The SIM card must be inserted into the J11 slot or the RS1™ will not connect to wireless or a CORS network.

## Assemble the Mounting Brackets

1. Use the supplied hardware to secure the RS1™ bottom bracket assembly (P/N 116-0159-802) to the adhesive strips.

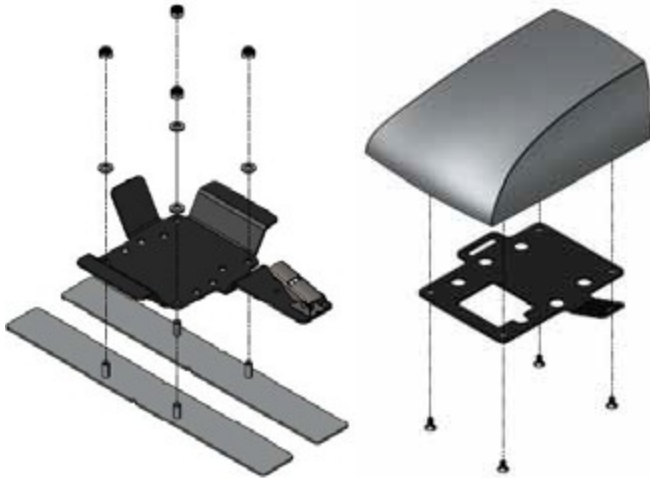

2. Mount the latch plate (P/N 107-0172-531) to the RS1™ using the provided screws.

**Note:** The bottom mounting bracket will adhere to the roof of the tractor. The latch plate stays mounted to the RS1™.

3. Secure the RS1™ latch plate to the fixed base plate using the latch.

## Prepare the Roof

1. Select a location on the cab roof to mount the RS1™. Consider all of the following mounting requirements for best functionality of RS1™:
  - RS1™ must be mounted at least 50 cm [20 in.] from other GNSS, cellular, or radio antennas or equipment.
  - Align the RS1™ on the center line of the tractor in front of the rear axle or toward the front of the cab.
  - RS1™ is mounted with the connectors facing toward the rear of the tractor.
2. Thoroughly clean the selected location.

3. Use the two adhesive strips to secure the bottom bracket assembly to the roof of the tractor. Attach the RS1™ brackets so that the RS1™

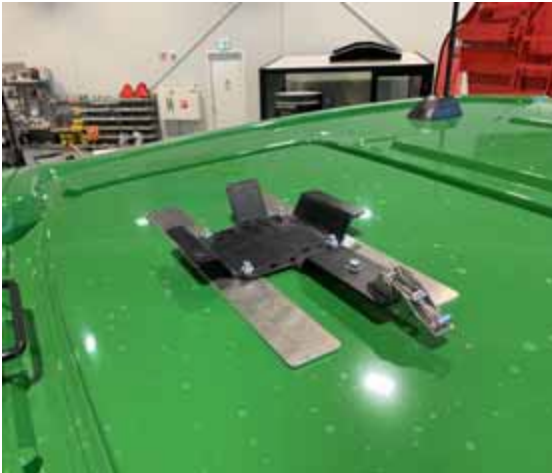

4. Secure the RS1™, already connected to the latch plate, onto the fixed plate.



5. Mount the round adhesive plate for the Laird cellular antenna (P/N 121-000-042) within 50 cm [20 in.] from the RS1™ bracket.

**Note:** *The LAIRD antenna is the main cellular antenna for the RS1™.*

## Connect RS1™ Cabling to DirecSteer

When installing an auto-steer system, the power cables should always be connected to the battery after all cables have been routed and connected. Two options are available:



- Implement Ready Power Harness (P/N 115-8000-060/315) with a ISObus IBBC connector
- Basic Power Harness (P/N 115-8000-141)

The Implement Ready Power Harness is the only harness with the ISObus IBBC connector, and should be mounted on the back of the tractor.

## Best Mounting Practices

Ensure the installer follows all of the following guidelines for best mounting practices:

- Mount the relays in fixed position on a clean, dry, easily accessible spot.
- The red wire is positive (12V). The black wires is minus (ground). Ensure that the first part of the red wire cannot be damaged during operation.
- Do not tie down the extra length between the battery and the fuses, but ensure the cable is an appropriate length. Be sure to use cable sockets with the correct size for proper connection.
- If a ground switch is used in the tractor, connect the wiring harness behind the ground switch, not at the battery side of the ground switch.
- If a main (12V) switch is used in the tractor, connect the red wire to the wiring harness behind the main switch, not at the battery side of the main switch.
- If no main switch is used, always connect the wiring harness directly to the battery.
- If the system is connected to a 24V machine, always use a 24V to 12V converter. Never connect between the two batteries of a 24V machine.

- Tie down the harnesses so they are free from vibration and friction.

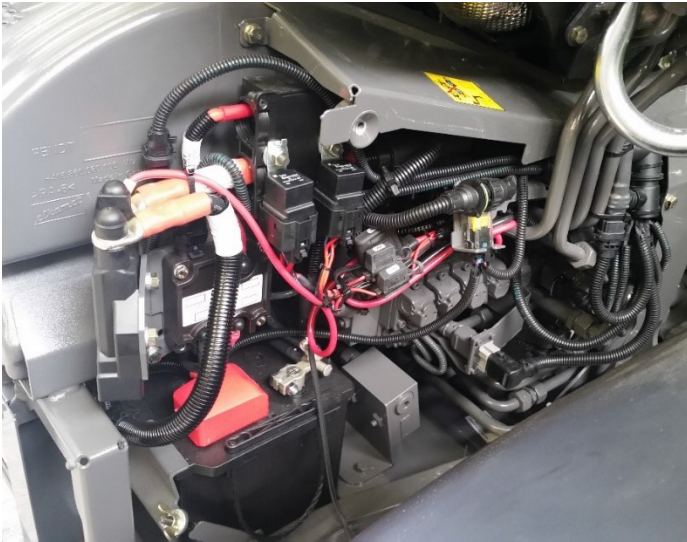

### Route the RS1™ Cabling to DirecSteer

1. Locate the battery of the tractor, normally located on the right side of the tractor, below the door/window.
2. Leave the black and red wires of the DirecSteer power cable (P/N 115-8000-473) near the battery to ensure the system can connect to power later.

#### **CAUTION**

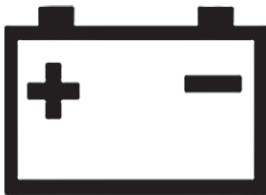

Do not connect the system power cable to the vehicle ignition or battery until all system components are mounted and all electrical connections are completed.

3. If Installing a Kit with IBBC:

- a. Starting from the battery, route the implement ready power harness (P/N 115-8000-060/315) through the machine so the IBBC connectors end up near the back of the machine.
- b. Ensure the 12-pin connector can still be routed into the cab of the machine.
- c. At the back of the machine, find the most appropriate mounting position for the IBBC connector. Be careful to consider moving parts or pinch points.
- d. Use the supplied tools to attach the IBBC connector (P/N 408-4002-131) to the mounting plate.
- e. Mount the IBBC plate and connector to the back of the machine.



- f. Connect the ISObus IBBC connector from the DirecSteer power harness (P/N 115-8000-060/315) to mounted IBBC connector.

If Installing a Kit without IBBC:

- a. Starting from the battery, route the basic power harness (P/N 115-8000-141) to a point in the machine where the 12-pin connector cable can enter the cabin.

4. Route the 12-pin connector from the DirecSteer power cable (P/N 115-8000-473) and DirecSteer power harness (P/N 115-8000-060/315 or 115-8000-141) into the cab of the machine.

**Note:** A harness extension cable (P/N 115-8000-214) is available if needed.



5. In the cab, route the RS1™ T-cable (P/N 115-8000-330) from the side console to the roof. The cable can be routed to the roof through the pillar (recommended) or outside of the cab and attached to the pillar cab post.
6. Install the black 12-pin connector of the RS1™ T-cable (P/N 115-8000-330) to the port on the back of the RS1™.



7. In the cab, connect the gray 12-pin connector of the RS1™ T-cable (P/N 115-8000-330) to the mating connector of the DirecSteer power harness (P/N 115-8000-060/315 or 115-8000-141).
8. Route cabling behind the lining.
9. Connect the 2-pin Deutsch connector from the DirecSteer power cable (P/N 115-8000-473) to the mating 2-pin connector on the DirecSteer main harness (P/N 115-8000-474).

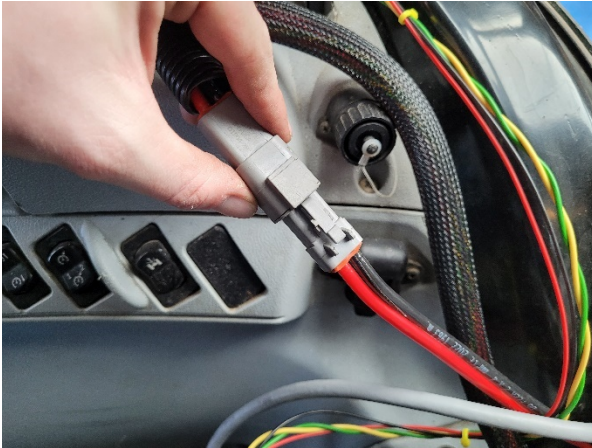

10. Connect the two 4-pin Deutsch connector from the DirecSteer main cable (P/N 115-8000-474) to the mating CAN 2 connectors on the RS1™ T-cable (P/N 115-8000-330).



11. Locate an open or free console cavity for the road switch and remove the blank.

12. Route the road switch connector from the DirecSteer main cable (P/N 115-8000-474) through the open cavity and connect it to the road switch.

**Note:** Use the provided adapter for the switch if needed.





13. Press the switch assembly into the cavity to seat the switch.



**Note:** *If needed, use the supplied switch adapter (P/N 412-8000-037) when installing in a larger sized cavity.*

14. Route the DirecSteer motor cable (P/N 115-4001-257) from the DirecSteer assembly down through the housing of the steering column and to the pedals.

15. Route the 8-pin connector of the DirecSteer motor cable (P/N 115-4001-257) under the floor mat to the mating connector labeled "DD Steer Motor Cable" on the DirecSteer main cable (P/N 115-8000-474) located in the side console.



16. Connect the DirecSteer motor cable (P/N 115-4001-257) to the DirecSteer assembly.



17. Connect the 12-pin connector of the field computer harness to the mating connector of the RS1™ T-cable (P/N 115-8000-330).



18. Connect the field computer cable to the mating connectors on the back of the display.

**Note:** Refer to System Diagrams for cable part numbers and refer to [https://ravenindustries.mcoutput.com/fieldcomp/en-us/Content/0-General/CRX\\_DeviceOverview.htm](https://ravenindustries.mcoutput.com/fieldcomp/en-us/Content/0-General/CRX_DeviceOverview.htm) for specific device connections.



19. Once everything is installed and connected, hide the cabling behind the lining whenever possible, and tie down the cabling where appropriate to avoid loose cabling.

## Connect to Power

### CAUTION

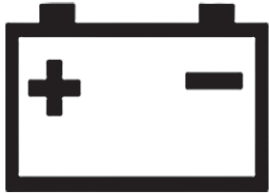

Do not connect the system power cable to the vehicle ignition or battery until all system components are mounted and all electrical connections are completed.

1. Locate the battery terminal rings on the DirecSteer power cable (P/N 115-8000-473) and power harness (P/N 115-8000-060/315 or 115-8000-141).
2. Locate and open the battery compartment.



**Note:** Generally, the battery compartment is located on the right side of the tractor, in front of the rear tire and below or beside the tractor cab.

3. Route the black and red ring terminals from the power cable and power harness into the battery compartment.

4. Connect the red lead(s) to the positive battery terminal and the black lead(s) to the negative battery terminal.

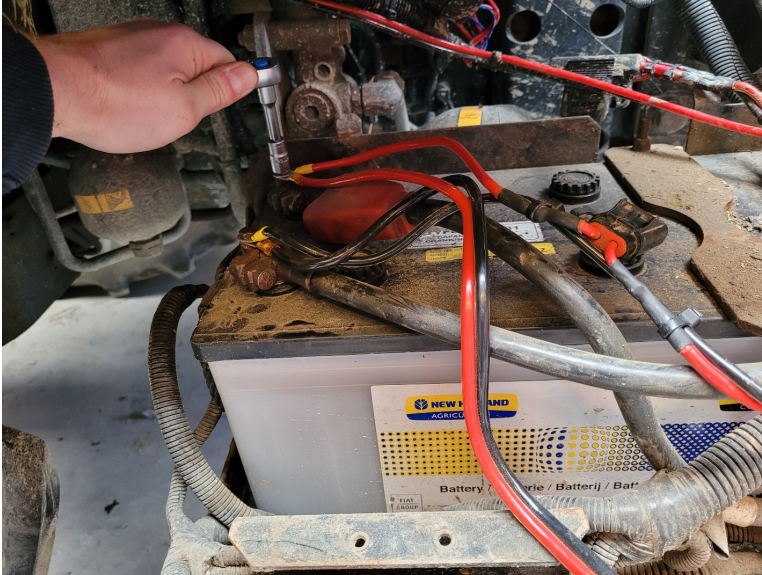

## RS1™ and DirecSteer System Diagrams

The following sections contain example diagrams of various systems which may interface with the auto-steer system.



DirecSteer System Diagram w/ RS1™ and CR7™ w/o IBBC (P/N 054-5030-312 Rev. A, Pg. 2)

SYSTEM DRAWING, DIRECSTEER, GENERIC, W/O IBBC, RS1, CR7

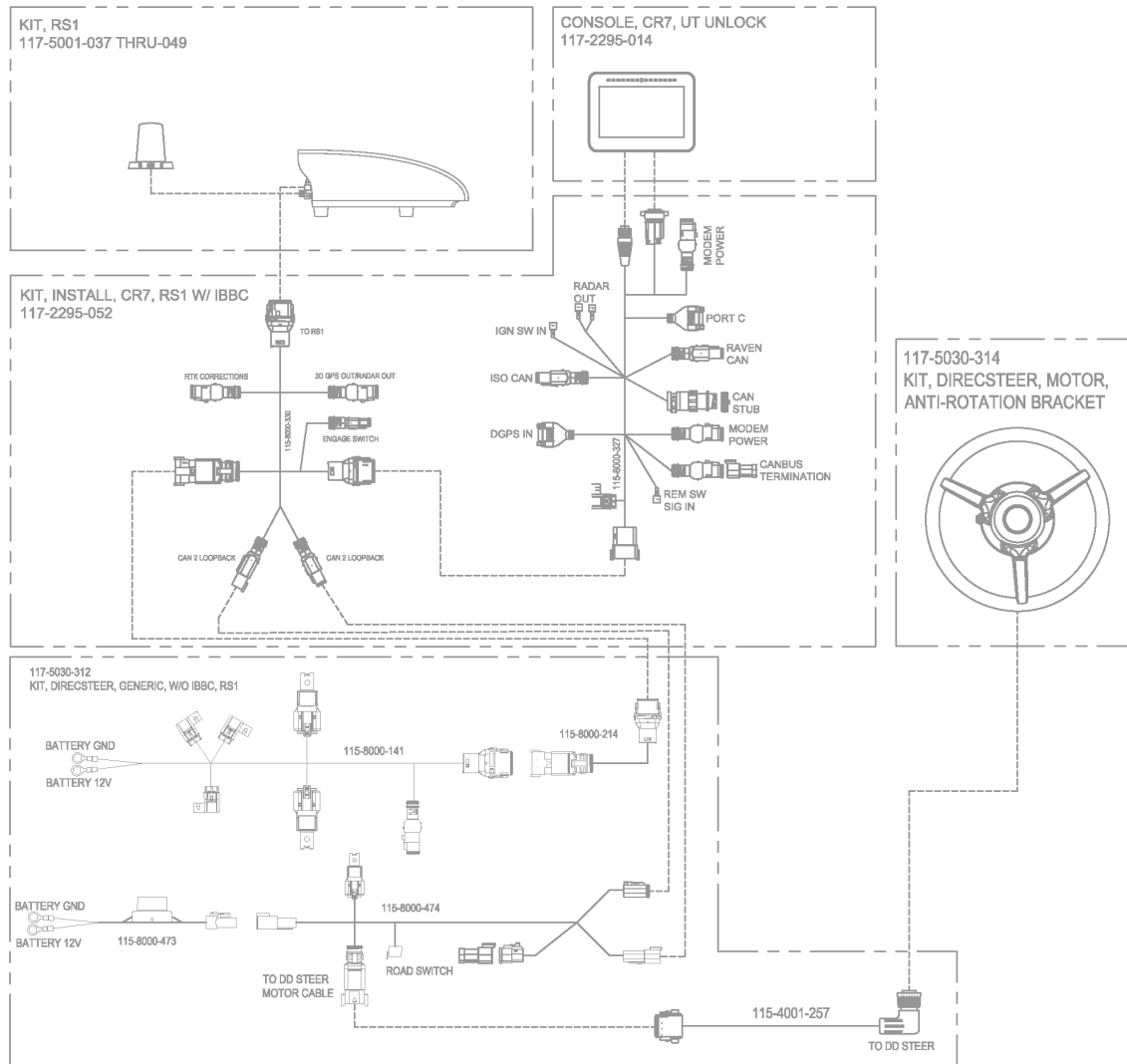

DirecSteer System Diagram w/ RS1™, CR12™, and IBBC (P/N 054-5030-313 Rev. A, Pg. 1)

SYSTEM DRAWING, DIRECSTEER, GENERIC, W/ IBBC, RS1, CR12

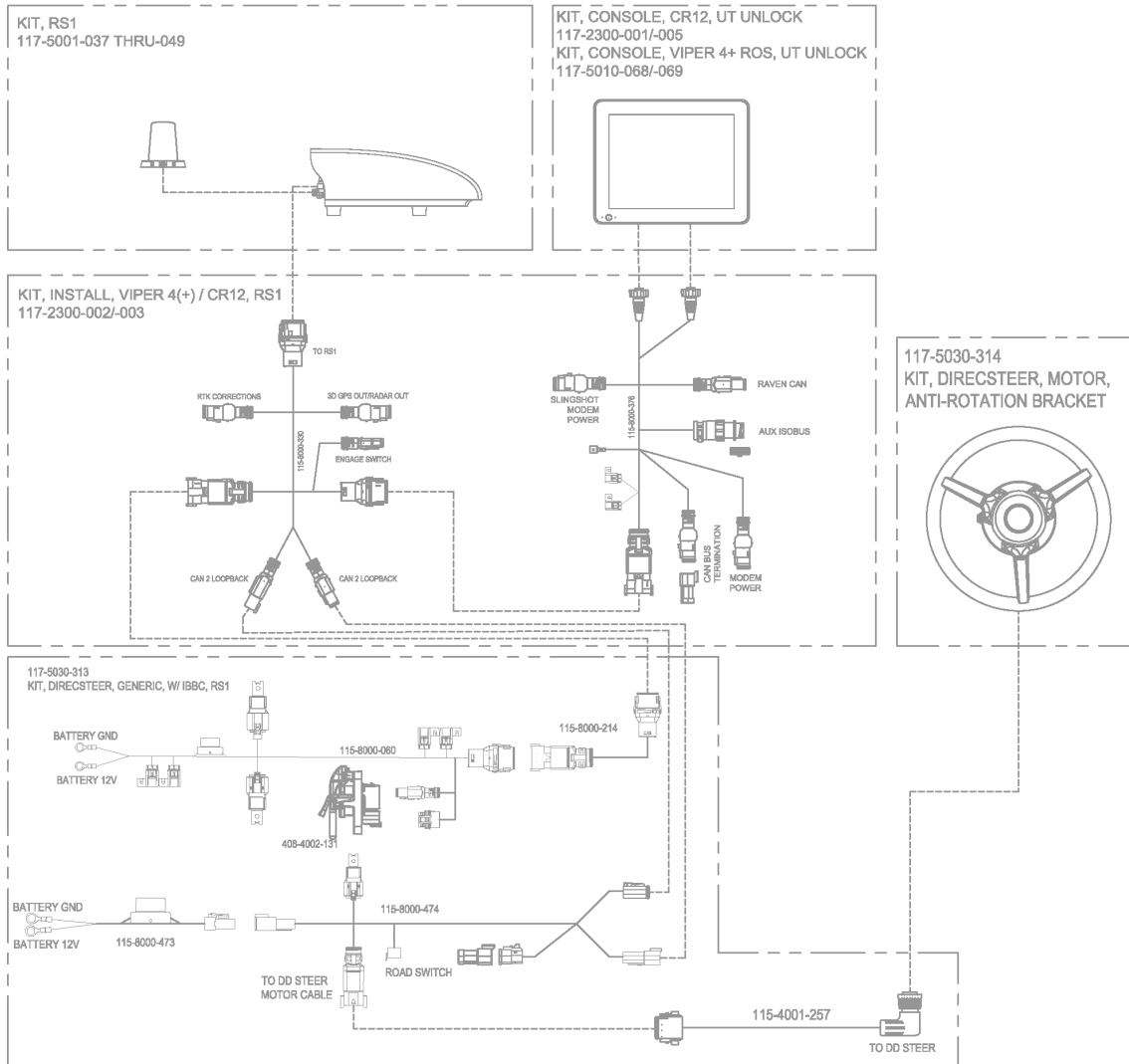

DirecSteer System Diagram w/ RS1™, CR7™, and IBBC (P/N 054-5030-313 Rev. A, Pg. 2)

SYSTEM DRAWING, DIRECSTEER, GENERIC, W/ IBBC, RS1, CR7

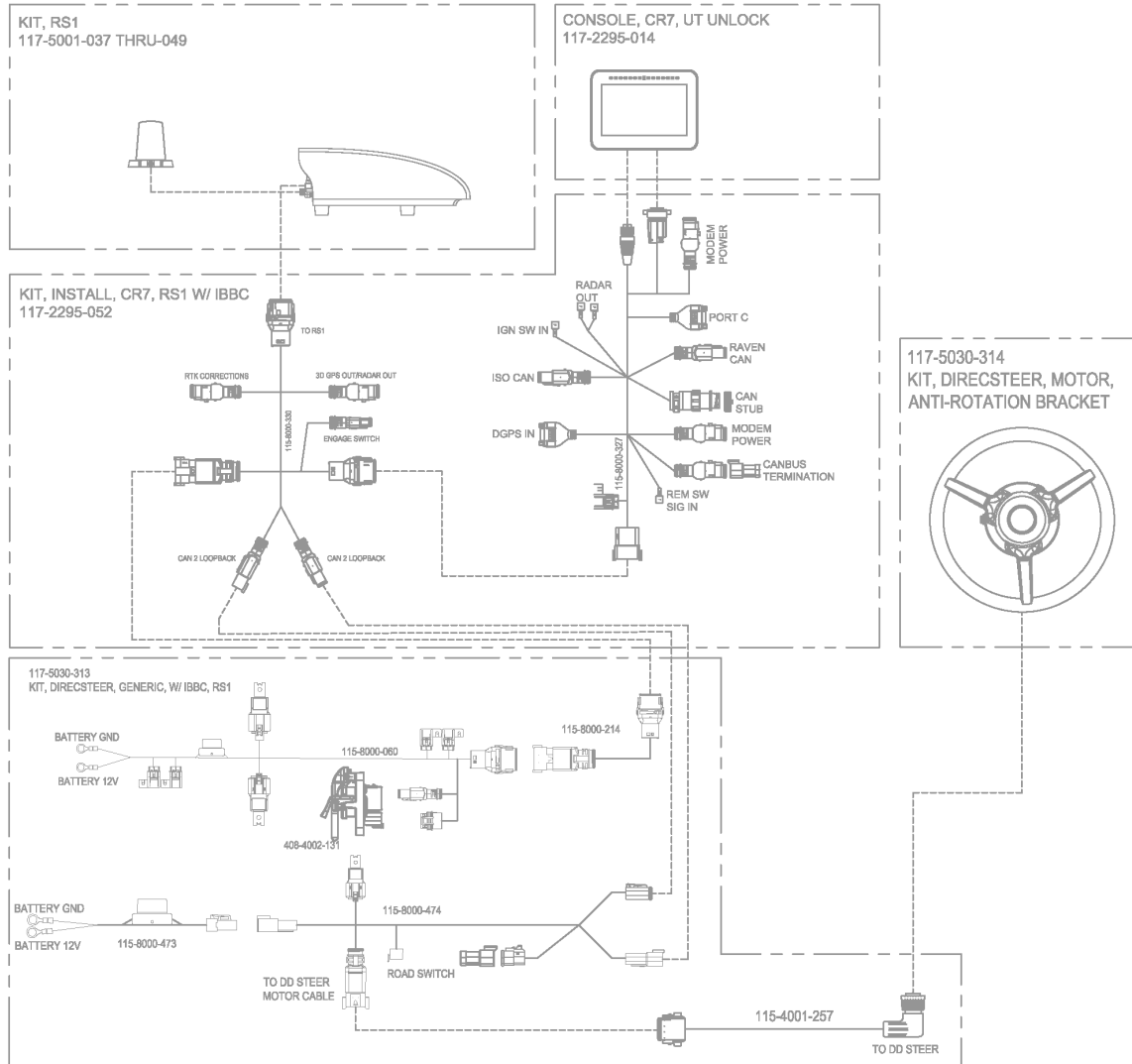





# Chapter 6:

## Install SC1™/TC1™ with DirecSteer

**Note:** This section only applies to DirecSteer kits with SC1™/TC1™ guidance. For RS1™ information, see "Install RS1™ with DirecSteer" on page 35.

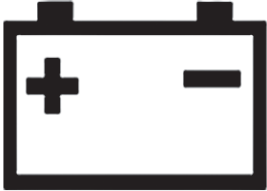
<b>CAUTION</b>	
	<p>Do not connect the system power cable to the vehicle ignition or battery until all system components are mounted and all electrical connections are completed.</p>

<a href="#">Install the SC1™/TC1™ Unit</a> .....	56
<a href="#">Install the Antenna</a> .....	58
<a href="#">Install the 500S™ Receiver</a> .....	58
<a href="#">Install the 700S™ Receiver</a> .....	59
<a href="#">Connect SC1™ Cabling to DirecSteer</a> .....	59
<a href="#">Best Mounting Practices</a> .....	60
<a href="#">Route the SC1™ Cabling to DirecSteer</a> .....	61
<a href="#">Connect the 500S™/700S™ Antenna</a> .....	69
<a href="#">Connect to Power</a> .....	69
<a href="#">SC1™ and DirecSteer System Diagrams</a> .....	71

## Install the SC1™/TC1™ Unit

### NOTICE



Depending upon the make and model of the machine, the steps required to complete the installation of the RS1™/SC1™ with DirecSteer auto-steer system may differ from the instructions provided in the following procedure.

**Note:** Contact an authorized dealer for assistance with ordering or installing the SC1™ mounting kit for a specific machine.

1. Install the SC1™ on the mounting bracket (P/N 107-8000-125/157) using the supplied screws from the Node Seat Mount Bracket Kit (P/N 117-8000-255).
2. Locate the desired installation position next to the seat.
3. Remove the two flange bolts on the right side of the seat.

4. Install the mounting bracket (P/N 107-8000-125/157) using the bolts removed in the previous step.

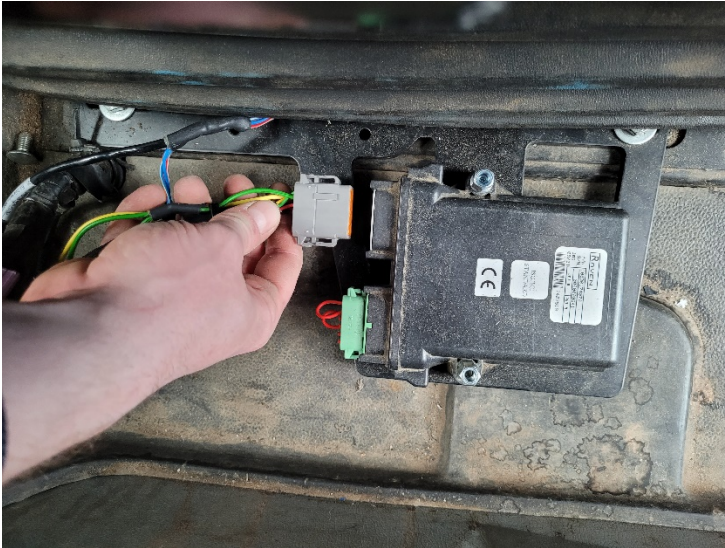

## Install the Antenna

### Install the 500S™ Receiver



500S™ only allows for the following installation options. To install the antenna:

1. Use the provided screws to secure the antenna mounting base to the antenna. Verify the power and signal notch on the antenna mounting base faces towards the power and signal connection on the bottom of the antenna.



2. Install the adapter in the threaded hole of the antenna mounting base.
3. If needed, secure the magnet mounting base to the roof cap.
4. Thread the adapter pole over the existing survey pole or to the magnet mounting base.

5. Thread the antenna onto the mounting base antenna until snug.

**Note:** *Hand-tighten only. Damage resulting from over-tightening is not covered by the warranty.*

6. Connect the power cable (P/N 115-0172-588) to the power port of the 500S™ unit.
7. Route the remaining connection of the power cable into the cab.

### Install the 700S™ Receiver



1. Attach the 700S™ receiver to the provided mounting plate.
2. Mount the mounting plate in an unobstructed position on the roof of the cab with connectors pointing to the rear of the machine.
3. Connect the power cable (P/N 115-0172-589) to the power port of the 700S™ unit.
4. Route the remaining connection of the power cable into the cab.

### Connect SC1™ Cabling to DirecSteer

When installing an auto-steer system, the power cables should always be connected to the battery after all cables have been routed and connected. Two options are available:

- Implement Ready Power Harness (P/N 115-8000-060/315) with a ISObus IBBC connector
- Basic Power Harness (P/N 115-8000-141)

The Implement Ready Power Harness is the only harness with the ISObus IBBC connector, and should be mounted on the back of the tractor.

### Best Mounting Practices

Ensure the installer follows all of the following guidelines for best mounting practices:

- Mount the relays in fixed position on a clean, dry, easily accessible spot.
- The red wire is positive (12V). The black wires is minus (ground). Ensure that the first part of the red wire cannot be damaged during operation.
- Do not tie down the extra length between the battery and the fuses, but ensure the cable is an appropriate length. Be sure to use cable sockets with the correct size for proper connection.
- If a ground switch is used in the tractor, connect the wiring harness behind the ground switch, not at the battery side of the ground switch.
- If a main (12V) switch is used in the tractor, connect the red wire to the wiring harness behind the main switch, not at the battery side of the main switch.
- If no main switch is used, always connect the wiring harness directly to the battery.
- If the system is connected to a 24V machine, always use a 24V to 12V converter. Never connect between the two batteries of a 24V machine.
- Tie down the harnesses so they are free from vibration and friction.



## Route the SC1™ Cabling to DirecSteer

1. Locate the battery of the tractor, normally located on the right side of the tractor, below the door/window.
2. Leave the black and red wires of the DirecSteer power cable (P/N 115-8000-473) near the battery to ensure the system can connect to power later.

### CAUTION

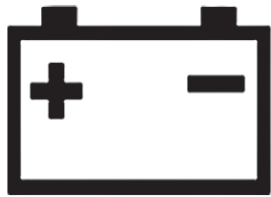

Do not connect the system power cable to the vehicle ignition or battery until all system components are mounted and all electrical connections are completed.



3. If Installing a Kit with IBBC:

- a. Starting from the battery, route the implement ready power harness (P/N 115-8000-060/315) through the machine so the IBBC connectors end up near the back of the machine.
- b. Ensure the 12-pin connector can still be routed into the cab of the machine.
- c. At the back of the machine, find the most appropriate mounting position for the IBBC connector. Be careful to consider moving parts or pinch points.
- d. Use the supplied tools to attach the IBBC connector (P/N 408-4002-131) to the mounting plate.
- e. Mount the IBBC plate and connector to the back of the machine.



- f. Connect the ISObus IBBC connector from the DirecSteer power harness (P/N 115-8000-060/315) to mounted IBBC connector.

If Installing a Kit without IBBC:

- a. Starting from the battery, route the basic power harness (P/N 115-8000-141) to a point in the machine where the 12-pin connector cable can enter the cabin.



4. Route the 12-pin connector from the DirecSteer power cable (P/N 115-8000-473) and DirecSteer power harness (P/N 115-8000-060/315 or 115-8000-141) into the cab of the machine.

**Note:** A harness extension cable (P/N 115-8000-214) is available if needed.



5. Connect the 2-pin Deutsch connector from the DirecSteer power cable (P/N 115-8000-473) to the mating 2-pin connector on the DirecSteer main harness (P/N 115-8000-474).

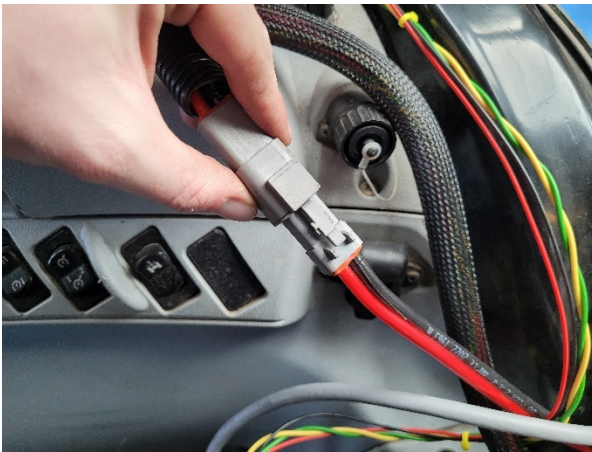

6. Connect the two 4-pin Deutsch connector from the DirecSteer main cable (P/N 115-8000-474) to the mating CAN 2 connectors on the SC1™ in-cab harness (P/N 115-8000-475).



7. Locate an open or free console cavity for the road switch and remove the blank.
8. Route the road switch connector from the DirecSteer main cable (P/N 115-8000-474) through the open cavity and connect it to the road switch.

**Note:** Use the provided adapter for the switch if needed.



9. Press the switch assembly into the cavity to seat the switch.



**Note:** *If needed, use the supplied switch adapter (P/N 412-8000-037) when installing in a larger sized cavity.*

10. Connect the female 12-pin connector of the SC1™/TC1™ cable (P/N 115-8000-475) to the 12-pin connector of the DirecSteer power harness (P/N 115-8000-060/315 or 115-8000-141) coming into the cab of the tractor.

**Note:** *This can be done behind the covers behind the seat in most tractors. Make sure the green and gray connectors can be removed from behind the covers to insert them in the SC1™ in a later step.*



11. Connect the male 12-pin connector from the SC1™ harness (P/N 115-8000-475) to the 12-pin connector on the field computer harness (P/N 115-8000-064/327).

**Note:** *Make sure when this cable can reach the area where the terminal is going to be installed.*



12. Connect the terminal connectors of the field computer harness (P/N 115-8000-064/327) to the back of the terminals.

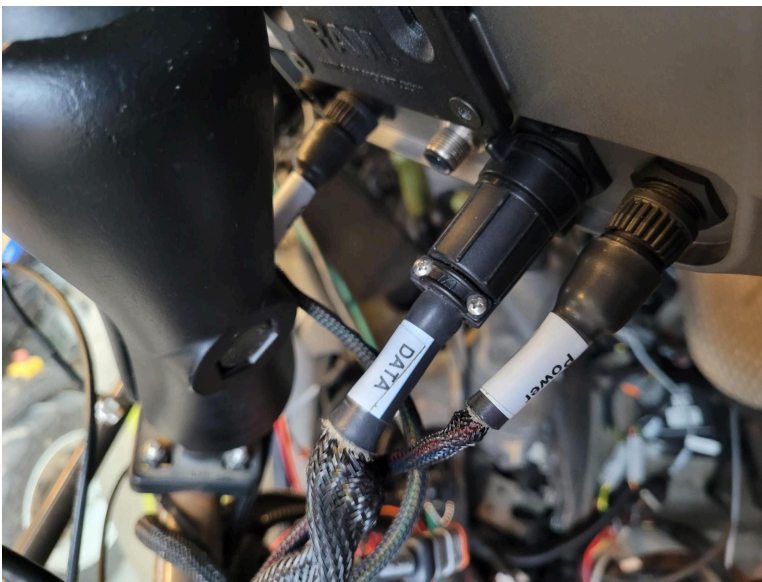

**Note:** Refer to System Diagrams for cable part numbers and refer to [https://ravenindustries.mcoutput.com/fieldcomp/en-us/Content/0-General/CRX\\_DeviceOverview.htm](https://ravenindustries.mcoutput.com/fieldcomp/en-us/Content/0-General/CRX_DeviceOverview.htm) for specific device connections.

13. Connect the green and the gray 12-pin connectors from the in-cab SC1™ harness cable (P/N 115-8000-475) to the SC1™ unit.

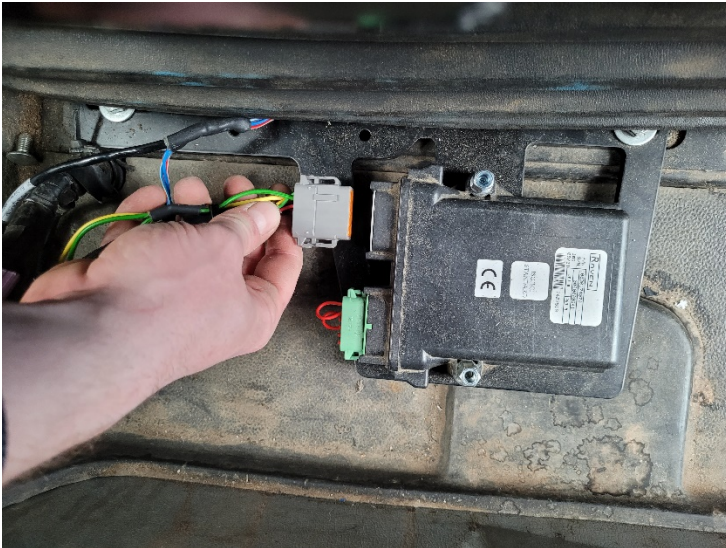

14. Route the DirecSteer motor cable (P/N 115-4001-257) from the DirecSteer assembly down through the housing of the steering column and to the pedals.
15. Route the 8-pin connector of the DirecSteer motor cable (P/N 115-4001-257) under the floor mat to the mating connector labeled "DD Steer Motor Cable" on the DirecSteer main cable (P/N 115-8000-474) located in the side console.



16. Connect the DirecSteer motor cable (P/N 115-4001-257) to the DirecSteer assembly.



17. Once everything is installed and connected, hide the cabling behind the lining whenever possible, and tie down the cabling where appropriate to avoid loose cabling.

### Connect the 500S™/700S™ Antenna

1. Route the smart antenna cable (P/N 115-8000-349) from the field computer to the roof. The cable can be routed to the roof through the pillar (recommended) or outside of the cab and attached to the pillar cab post.
2. Connect the smart antenna cable to the mating connector of the antenna adapter cable (P/N 115-0172-588/589).
3. Back in the cab, connect the "DGPS OUT" connector on the smart antenna cable (P/N 115-8000-349) to the mating connector of the in-cab SC1™ harness cable (P/N 115-8000-475).

### Connect to Power

#### CAUTION

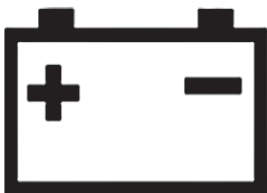

Do not connect the system power cable to the vehicle ignition or battery until all system components are mounted and all electrical connections are completed.



1. Locate the battery terminal rings on the DirecSteer power cable (P/N 115-8000-473) and power harness (P/N 115-8000-060/315 or 115-8000-141).
2. Locate and open the battery compartment.



**Note:** Generally, the battery compartment is located on the right side of the tractor, in front of the rear tire and below or beside the tractor cab.

3. Route the black and red ring terminals from the power cable and power harness into the battery compartment.
4. Connect the red lead(s) to the positive battery terminal and the black lead(s) to the negative battery terminal.

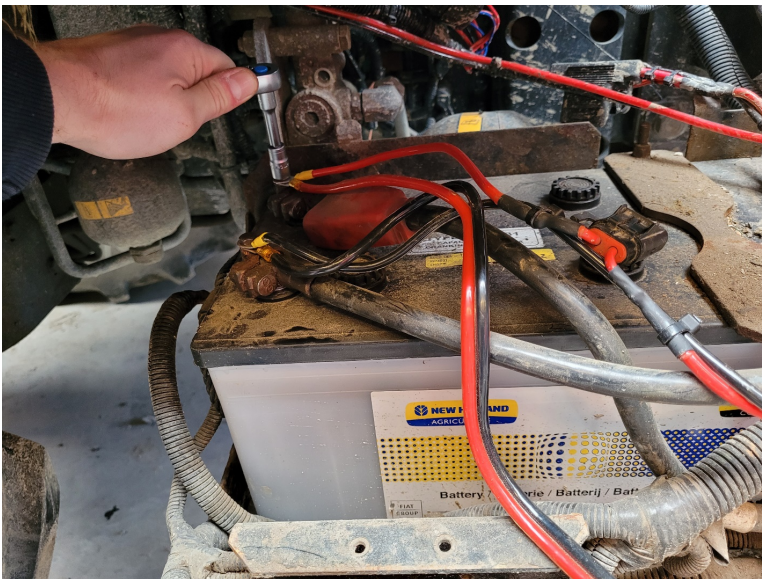



# SC1™ and DirecSteer System Diagrams

The following sections contain example diagrams of various systems which may interface with the auto-steer system.

DirecSteer System Diagram w/ SC1™ and CR12™ w/o IBBC (P/N 054-5030-310 Rev. A, Pg. 1)

## SYSTEM DRAWING, DIRECSTEER, GENERIC, W/O IBBC, SC1, CR12

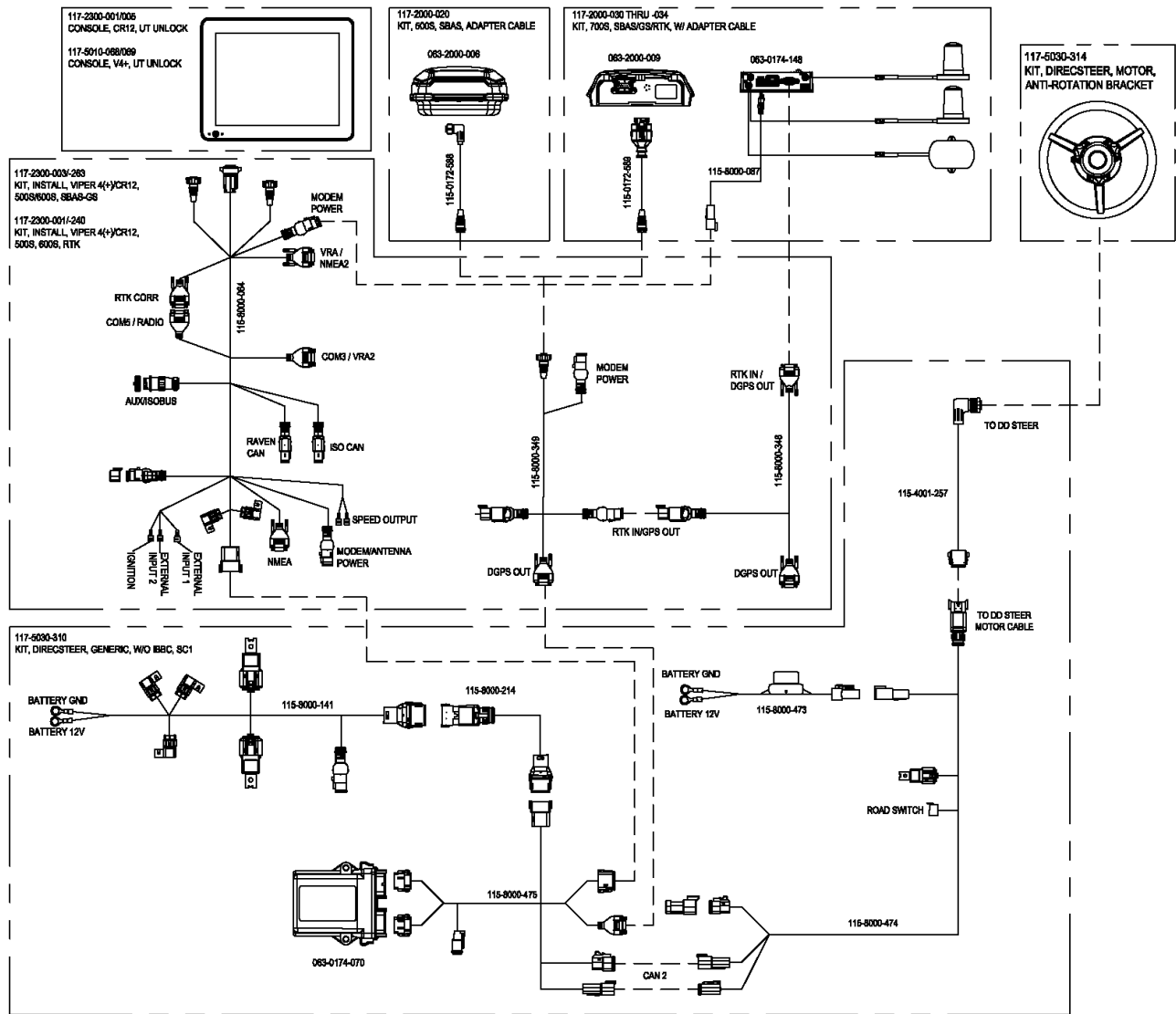

DirecSteer System Diagram w/ SC1™ and CR7™ w/o IBBC (P/N 054-5030-310 Rev. A, Pg. 2)

SYSTEM DRAWING, DIRECSTEER, GENERIC, W/O IBBC, SC1, CR7

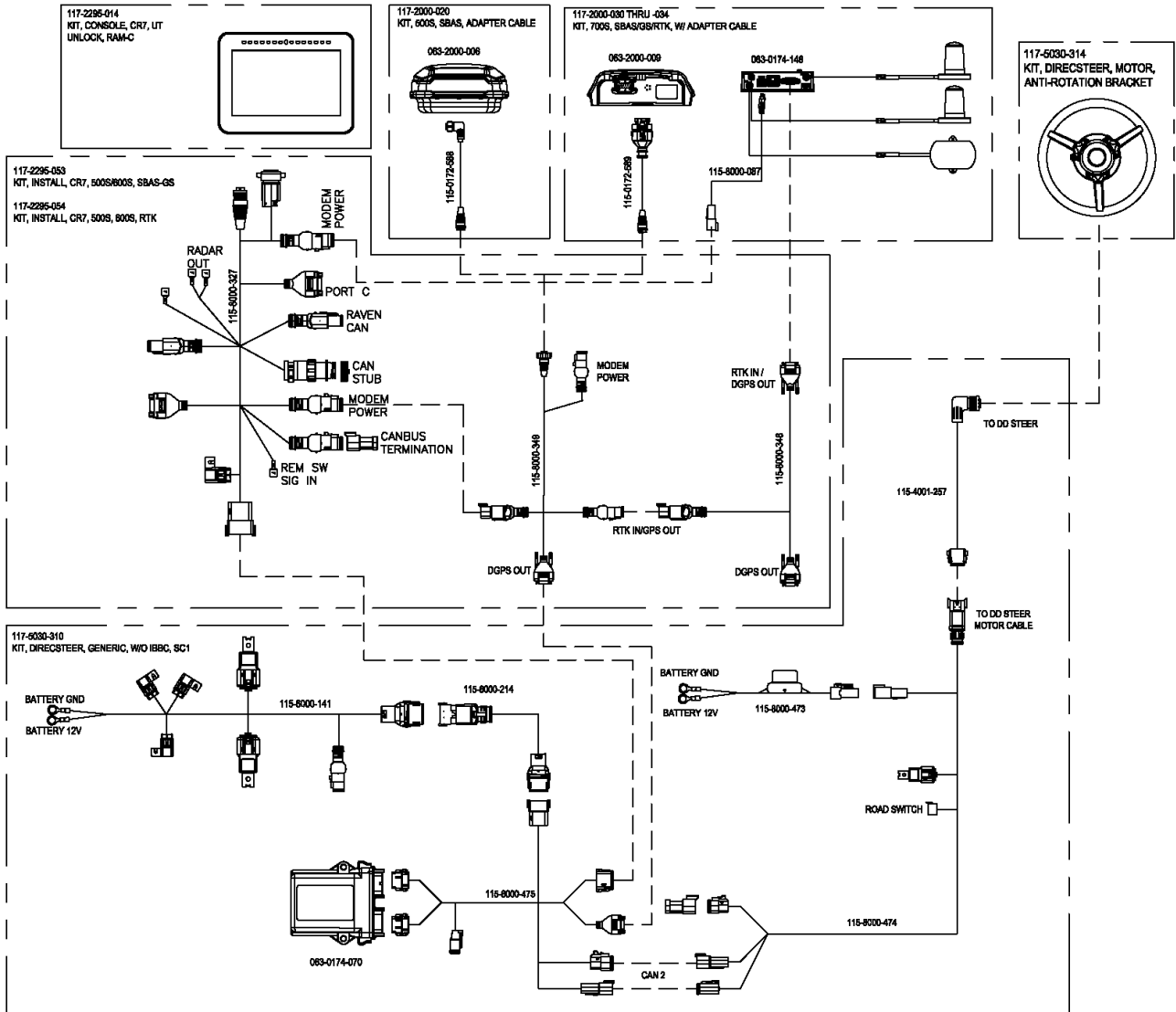



DirecSteer System Diagram w/ SC1™, CR7™, and IBBC (P/N 054-5030-311 Rev. A, Pg. 2)

SYSTEM DRAWING, DIRECSTEER, GENERIC, W/ IBBC, SC1, CR7

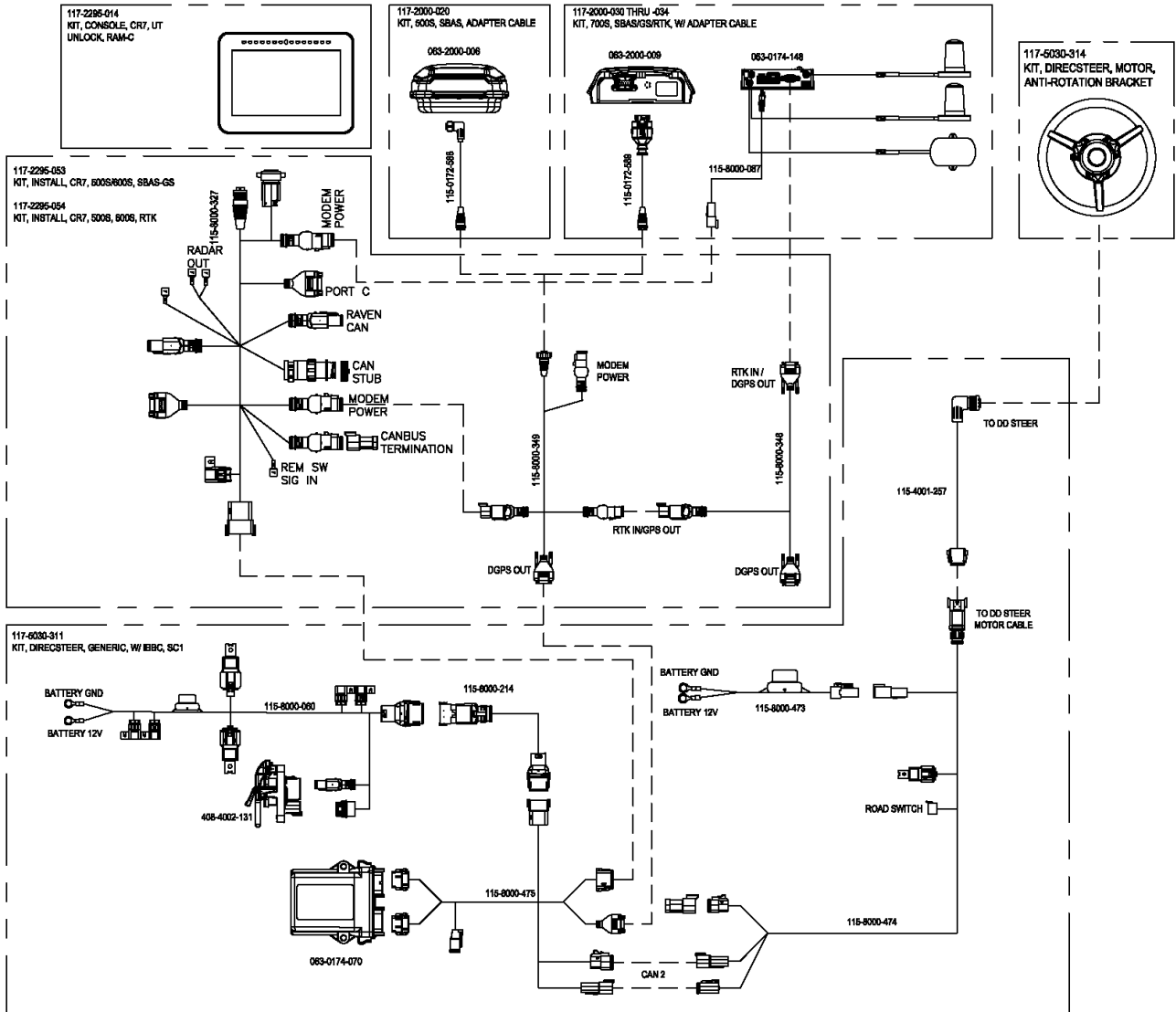

---

# Limited and Extended Warranties

---

## Limited Warranty

What does this warranty cover?

This warranty covers all defects in workmanship or materials in your Raven Applied Technology Division product under normal use, maintenance, and service when used for intended purpose.

How long is the coverage period?

Raven Applied Technology products are covered by this warranty for 12 months from the date of retail sale. In no case will the Limited Warranty period exceed 36 months from the date the product was issued by Raven Industries Applied Technology Division. This warranty coverage applies only to the original owner and is non-transferable.

How can I get service?

Bring the defective part and proof of purchase to your Raven dealer. If the dealer approves the warranty claim, the dealer will process the claim and send it to Raven Industries for final approval. The freight cost to Raven Industries will be the customer's responsibility. The Return Materials Authorization (RMA) number must appear on the box and all documentation (including completed RMA form, Certificate of Decontamination, and retail proof of purchase) must be included inside the box to be sent to Raven Industries.

What will Raven Industries do?

Upon confirmation of the warranty claim, Raven Industries (at our discretion) repair or replace this product or any component of the product found to be defective during the warranty period. Replacement will be made with a new or remanufactured product or component. Standard return freight will be paid, regardless of inbound shipping method. Expedited freight is available at the customer's expense.

What is not covered by this warranty?

Raven Industries will not assume any expense or liability for repairs outside our facility without written consent. Raven Industries is not responsible for damage to any associated equipment or products and will not be liable for loss of profit, labor, or other damages. The

---

obligation of this warranty is in lieu of all other warranties, expressed or implied, and no person or organization is authorized to assume any liability for Raven Industries.

- Damages caused by normal wear and tear, misuse, abuse, neglect, accident, improper installation and maintenance are not covered by this warranty.
- Worn/Chafed hoses and cables.
- Items in contact with fluids and chemicals including seals and O-rings.
- Software downloads and updates.
- Tamper-Evident label broken or customer disassembly.
- Any customer modification to the original product outside normal calibration and adjustments, without written approval.
- Intentional modification to cables.
- Failures due to lack of cleaning or preventive maintenance, and any condition, malfunction or damage not resulting from defects in material or workmanship.
- Items in contact with fluids or chemicals, returned without proper cleaning, decontamination and documentation.

## Extended Warranty

What does this warranty cover?

This warranty covers all defects in workmanship or materials in your Raven Applied Technology Division product under normal use, maintenance, and service when used for intended purpose.

Do I need to register my product to qualify for the extended warranty?

Yes. Products/systems must be registered within 30 days of retail sale to receive coverage under the Extended Warranty. If the component does not have a serial tag, the kit it came in must be registered instead.

Where can I register my product for the extended warranty?

To register, go online to <https://portal.ravenprecision.com> and select Product Registration.

To register, fill out the [Product Registration](#) form online at <https://portal.ravenprecision.com>.

---

## How long is the extended warranty coverage period?

Raven Applied Technology products that have been registered online are covered for an additional 12 months beyond the Limited Warranty for a total coverage period of 24 months from the date of retail sale. In no case will the Extended Warranty period exceed 36 months from the date the product was issued by Raven Industries Applied Technology division. This Extended Warranty coverage applies only to the original owner and is non-transferable.

## How can I get service?

Bring the defective part and proof of purchase to your Raven dealer. If the dealer approves the warranty claim, the dealer will process the claim and send it to Raven Industries for final approval. The freight cost to Raven Industries will be the customer's responsibility. The Return Materials Authorization (RMA) number must appear on the box and all documentation (including completed RMA form, Certificate of Decontamination, and Extended Warranty Registration Number) must be included inside the box to be sent to Raven Industries. In addition, the words "Extended Warranty" must appear on the box and all documentation if the failure is between 12 and 24 months from the retail sale.

## What will Raven Industries do?

Upon confirmation of the warranty claim, Raven Industries (at our discretion) repair or replace this product or any component of the product found to be defective during the warranty period. Replacement will be made with a new or remanufactured product or component. Standard return freight will be paid, regardless of inbound shipping method. Expedited freight is available at the customer's expense.

## What is not covered by this warranty?

Raven Industries will not assume any expense or liability for repairs outside our facility without written consent. Raven Industries is not responsible for damage to any associated equipment or products and will not be liable for loss of profit, labor, or other damages. The obligation of this warranty is in lieu of all other warranties, expressed or implied, and no person or organization is authorized to assume any liability for Raven Industries.

- Damages caused by normal wear and tear, misuse, abuse, neglect, accident, improper installation and maintenance are not covered by this warranty.
- Worn/Chafed hoses and cables.
- Items in contact with fluids and chemicals including seals and O-rings.

- 
- Software downloads and updates.
  - Tamper-Evident label broken or customer disassembly.
  - Any customer modification to the original product outside normal calibration and adjustments, without written approval.
  - Intentional modification to cables.
  - Failures due to lack of cleaning or preventive maintenance, and any condition, malfunction or damage not resulting from defects in material or workmanship.
  - Items in contact with fluids or chemicals, returned without proper cleaning, decontamination and documentation.