

# SYSTEM DRAWING, OPTIONAL WHEEL ANGLE SENSORS, CABLING AND BRACKETRY

B



CABLE, WHEEL ANGLE SENSOR TO HDU CABLE  
1.5M - 115-8000-193  
5.0M - 115-8000-226



EXTENSION CABLE, WHEEL ANGLE SENSOR  
3.0M - 433-8000-038  
5.0M - 433-8000-040  
10.0M - 433-8000-041

## WHEEL ANGLE SENSOR ASSEMBLIES/KITS

WHEEL ANGLE SENSOR  
90° - 063-8000-070  
180° - 063-5000-017



WHEEL ANGLE SENSOR IN BRACKET  
90° - 063-8000-066  
180° - 063-8000-068

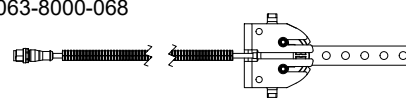

WHEEL ANGLE SENSOR IN BRACKET, LONG  
90° - 063-8000-157  
180° - 063-8000-168

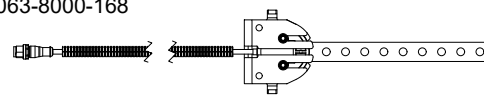

## LINKAGE FOR WHEEL ANGLE SENSOR IN BRACKET

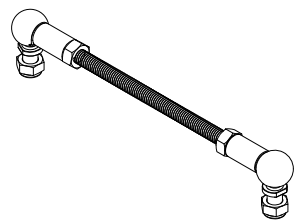

KIT, WAS LINK, M8, RAD-RAD  
210MM - 117-8000-307  
300MM - 117-8000-546

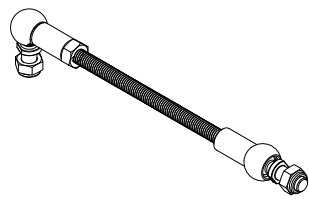

KIT, WAS LINK, M8, RAD-AXL  
210MM - 117-8000-308

KIT, WHEEL ANGLE SENSOR BRACKET, WITHOUT SENSOR  
117-8000-082

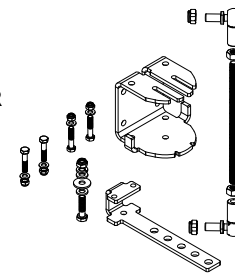

KIT, WHEEL ANGLE SENSOR, CARRARO FRONT AXLE  
117-8000-251

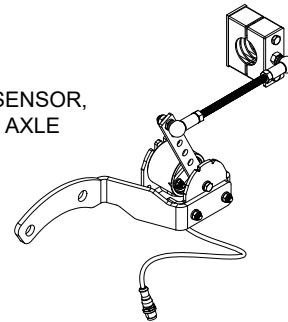

## SPY CABLE ASSEMBLIES

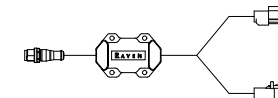

CNH 3-WIRE  
115-8000-151  
4 PIN FORD KEY 8

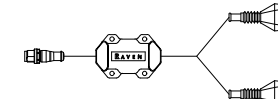

CNH 4P SUPERSEAL  
115-8000-324  
4 PIN AMP SUPERSEAL 1.5 SERIES

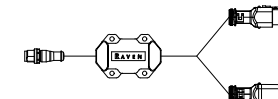

CNH MAGNUM/T8  
115-8000-152  
6 PIN DEUTSCH DT

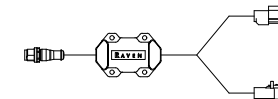

CNH 4-WIRE  
115-8000-468  
4 PIN FORD KEY 8

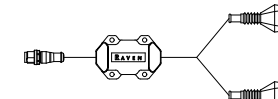

CLAAS AXION  
115-8000-136  
4 PIN AMP SUPERSEAL 1.5 SERIES

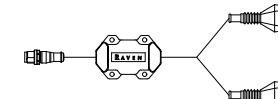

LANDINI  
115-8000-446  
4 PIN AMP SUPERSEAL 1.5 SERIES

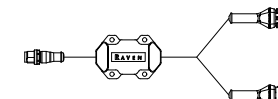

DEUTZ 6-7 SERIES  
115-8000-358  
3 PIN AMP SUPERSEAL 1.5 SERIES

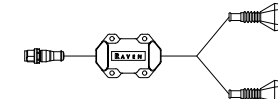

DEUTZ TTV 5-6-7 SERIES T4F 4P  
115-8000-463  
4 PIN AMP SUPERSEAL 1.5 SERIES

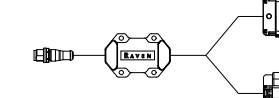

JOHN DEERE 5R  
115-8000-460  
16 PIN APTIV (DELPHI) GT 150/280

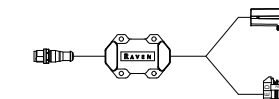

JOHN DEERE M/R SERIES  
115-8000-135  
6 PIN METRI-PACK 150 SERIES

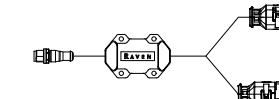

JOHN DEERE M/R SERIES  
115-8000-035  
4 PIN AMPSEAL 16

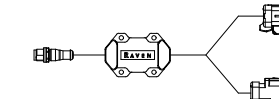

JOHN DEERE STEER READY 8R  
115-8000-148  
6 PIN AMPSEAL 16

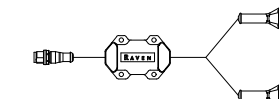

VALTRA  
115-8000-049  
3 PIN AMP SUPERSEAL 1.5 SERIES

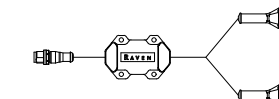

FENDT (NON COM3)  
115-8000-149  
3 PIN AMP SUPERSEAL 1.5 SERIES

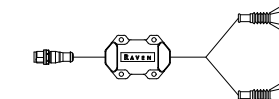

MASSEY FERGUSON  
115-8000-154  
4 PIN AMP SUPERSEAL 1.5 SERIES

B

A

A

RELEASED DATE	ECO #	REV.	DRAWING NO.
3/8/22	40891	A	054-8000-150

4

3

2

1

# SYSTEM DRAWING, OPTIONAL WHEEL ANGLE SENSORS, CABLING AND BRACKETRY

## BRACKETS FOR WHEEL HUB/AXLE INSTALLATION



WHEEL SENSOR PLATE,  
90X110MM  
107-8000-072

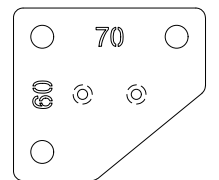

WHEEL SENSOR BRACKET,  
60X70MM  
107-8000-073

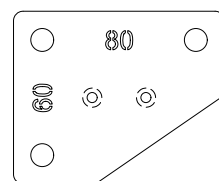

WHEEL SENSOR BRACKET,  
60X80MM  
107-8000-074

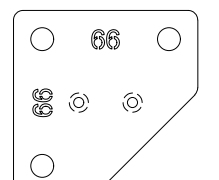

WHEEL SENSOR BRACKET,  
66X66MM  
107-8000-075

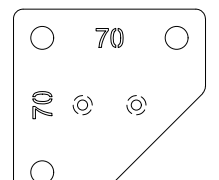

WHEEL SENSOR BRACKET,  
70X70MM  
107-8000-077

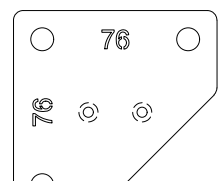

WHEEL SENSOR BRACKET,  
76X76MM  
107-8000-076

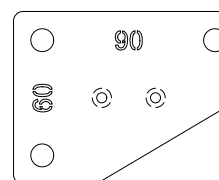

WHEEL SENSOR BRACKET,  
60X90MM  
107-8000-085

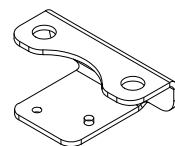

WHEEL SENSOR BRACKET,  
63.5MM  
107-8000-078

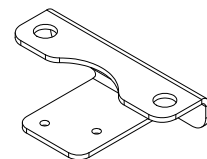

WHEEL SENSOR BRACKET,  
88.0MM  
107-8000-079

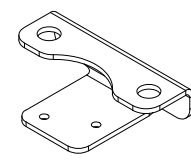

WHEEL SENSOR BRACKET,  
73.5MM  
107-8000-080

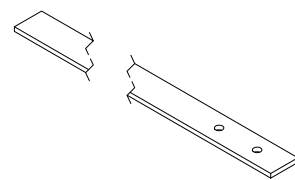

WHEEL SENSOR STRIP  
107-8000-071

## MOUNTING BRACKETS FOR USE WITH WHEEL ANGLE SENSOR IN BRACKET

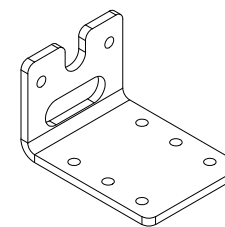

ANGLE SENSOR  
BRACKET, 90°  
107-8000-005

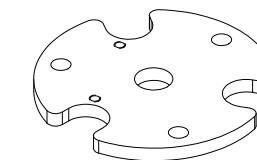

ANGLE SENSOR  
BRACKET, DEWULF  
OFFSET HARVESTER,  
REAR  
107-8000-104

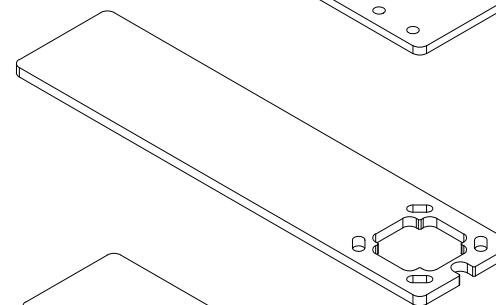

ANGLE SENSOR  
BRACKET, FLAT  
107-8000-066

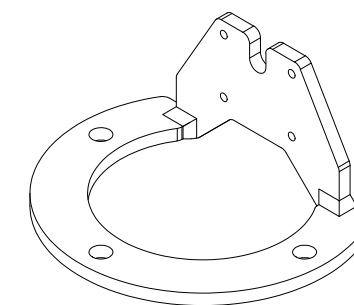

ANGLE SENSOR  
BRACKET, DEWULF  
OFFSET HARVESTER,  
FRONT 150MM  
116-8000-025

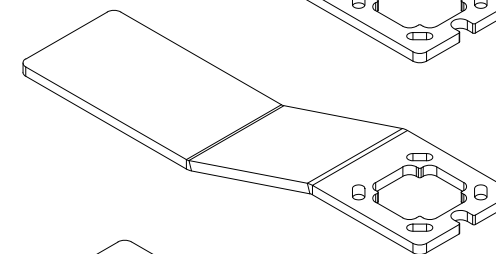

ANGLE SENSOR  
BRACKET, 3CM STEP  
107-8000-067

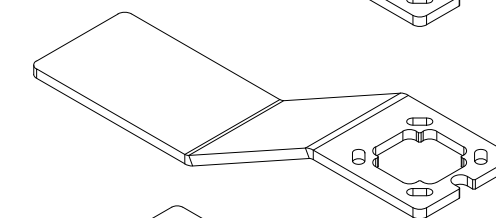

ANGLE SENSOR  
BRACKET, 5CM STEP  
107-8000-068

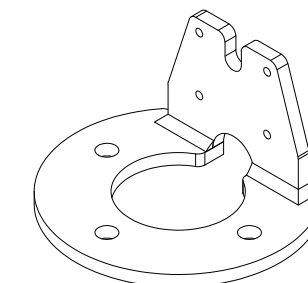

ANGLE SENSOR  
BRACKET, DEWULF  
OFFSET HARVESTER,  
FRONT 105MM  
116-8000-030

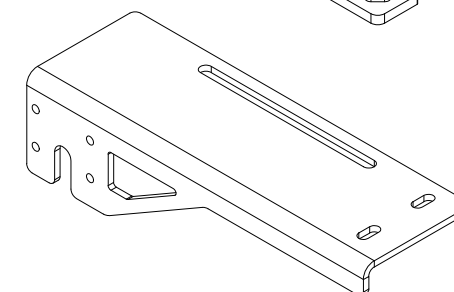

ANGLE SENSOR BRACKET,  
SIDESHIFT IMPLEMENT  
FRAME  
107-8000-086

SHEET 2 OF 2

RELEASED DATE	ECO #	REV.	DRAWING NO.
3/8/22	40891	A	054-8000-150

4

3

2

1

B

A

B

A