

VSN® Installation Manual for Challenger MT 7XX/ 8XX C/D/E

016-2023-005 Rev. A

4/2022

E40000



DISCLAIMER

While every effort has been made to ensure the accuracy of this document, Raven Industries assumes no responsibility for omissions and errors. Nor is any liability assumed for damages resulting from the use of information contained herein.

Raven Industries shall not be responsible or liable for incidental or consequential damages or a loss of anticipated benefits or profits, work stoppage or loss, or impairment of data arising out of the use, or inability to use, this system or any of its components. Raven Industries shall not be held responsible for any modifications or repairs made outside our facilities, nor damages resulting from inadequate maintenance of this system.

As with all wireless and satellite signals, several factors may affect the availability and accuracy of wireless and satellite navigation and correction services (e.g. GPS, GNSS, SBAS, etc.). Therefore, Raven Industries cannot guarantee the accuracy, integrity, continuity, or availability of these services and cannot guarantee the ability to use Raven systems, or products used as components of systems, which rely upon the reception of these signals or availability of these services. Raven Industries accepts no responsibility for the use of any of these signals or services for other than the stated purpose.

Chapter 1	Important Information.....	1
Safety		1
Electrical Safety		2
Recommendations and Best Practices		2
Hose Routing		2
Harness Routing		3
Chapter 2	Introduction.....	5
Preparing for Installation		5
Prerequisites		5
Recommendations		6
Point of Reference		6
Updates		6
Kit Contents		7
Chapter 3	Installation	9
Fabricate the VSN® bracket		9
VSN® Specifications		9
Mounting		9
System Diagram		13
Route the Cables		14
Install the (Optional) Analog Video Kit		16
Mount the Analog Display to CR7™		16
Cabling		17
System Diagram		17

SAFETY

NOTICE

Follow the operation and safety instructions included with the implement and/or controller and read this manual carefully before installing or operating this Raven system.

- Follow all safety information presented within this manual. Review implement operation with your local dealer.
- Contact a local Raven dealer for assistance with any portion of the installation, service, or operation of Raven equipment.
- Follow all safety labels affixed to system components. Be sure to keep safety labels in good condition and replace any missing or damaged labels. Contact a local Raven dealer to obtain replacements for safety labels.

Observe the following safety measures when operating the implement after installing this Raven system:

- Do not operate this Raven system or any agricultural equipment while under the influence of alcohol or an illegal substance.
- Be alert and aware of surroundings and remain in the operator seat at all times when operating this Raven system.
 - Do not operate the implement on any public road with this Raven system enabled.
 - Disable this Raven system before exiting the operator seat.
 - Determine and remain a safe working distance from obstacles and bystanders. The operator is responsible for disabling the system when a safe working distance has diminished.
 - Disable this Raven system prior to starting any maintenance work on the implement or components of this Raven system.
- Do not attempt to modify or lengthen any of the system control cables. Extension cables are available from a local Raven dealer.

 **CAUTION**

ELECTRICAL SAFETY

- Always verify that power leads are connected to the correct polarity as marked. Reversing the power leads could cause severe damage to the Raven system or other components.
- To prevent personal injury or fire, replace defective or blown fuses with only fuses of the same type and amperage.
- Do not connect the power leads to the battery until all system components are mounted and all electrical connections are completed.
- Always start the machine before initializing this Raven system to prevent power surges or peak voltage.
- To avoid tripping and entanglement hazards, route cables and harnesses away from walkways, steps, grab bars, and other areas used by the operator or service personnel when operating or servicing the equipment.

RECOMMENDATIONS AND BEST PRACTICES

HOSE ROUTING

The word “hose” is used to describe any flexible, fluid carrying components. Use the following guidelines and recommendations when connecting and routing hoses while installing or maintaining this Raven system:

- Leave protective caps/covers over hose ends until connecting the end into the hydraulic system to help prevent contaminants from entering the system.
- Follow existing hose runs already routed on the implement as much as possible. Proper hose routing should:
 - Secure hoses and prevent hoses from hanging below the implement.
 - Provide sufficient clearance from moving components and operational zones around shafts; universal joints and suspension components; pulleys, gears, belts, and chains; moving linkages, cylinders, articulation joints, etc.
 - Protect hoses from field debris and surrounding hazards (e.g. tree limbs, fence posts, crop stubble, dirt clumps or rocks that may fall or be thrown by the implement).
 - Protect hoses from sharp bends, twisting, or flexing over short distances and normal implement operation.
 - Ensure sufficient length for free movement of the implement during normal operation and prevent pulling, pinching, catching, or rubbing, especially in articulation and pivot points. Clamp hoses securely to force controlled movement of the hose.
 - Avoid abrasive surfaces and sharp edges such as sheared or flame cut corners, fastener threads or cap screw heads, hose clamp ends, etc.
 - Avoid areas where the operator or service personnel might step or use as a grab bar.
- Do not connect, affix, or allow hoses to come into contact with components with high vibration forces, hot surfaces, or components carrying hot fluids beyond the temperature rating of hose components.
 - Hoses should be protected or shielded if routing requires the hose to be exposed to conditions beyond hose component specifications.
- Avoid routing hoses in areas where damage may occur due to build up of material (e.g. dirt, mud, snow, ice, etc.).

HARNESS ROUTING

The word “harness” is used to describe any electrical cables and leads, both bundled and unbundled. Use the following guidelines and recommendations when connecting and routing harnesses while installing or maintaining this Raven system:

- Leave protective caps/covers over harness connectors until needed to avoid dirt and moisture from contaminating electrical circuits.
- Secure the harness to the frame or solid structural members at least every 12 in [30 cm].
- Follow existing harness runs already routed on the implement as much as possible. Proper harness routing should:
 - Secure harnessing and prevent the harness from hanging below the implement.
 - Provide sufficient clearance from moving components and operational zones around shafts; universal joints and suspension components; pulleys, gears, belts, and chains; moving linkages, cylinders, articulation joints, etc.
 - Protect harnessing from field debris and surrounding hazards (e.g. tree limbs, fence posts, crop stubble, dirt clumps or rocks that may fall or be thrown by the implement).
 - Protect harnessing from sharp bends, twisting, or flexing over short distances and normal implement operation.
 - Connectors and splices should not be located at bending points or in harness sections that move.
 - Ensure sufficient length for free movement of the implement during normal operation and prevent pulling, pinching, catching, or rubbing, especially in articulation and pivot points. Clamp harnessing securely to force controlled movement of the harness.
 - Avoid abrasive surfaces and sharp edges such as sheared or flame cut corners, fastener threads or cap screw heads, hose clamp ends, etc.
- Do not connect, affix, or allow harnessing to come into contact with components with high vibration forces, hot surfaces, or components carrying hot fluids beyond the temperature rating of harness components.
 - Harnessing should be protected or shielded if routing requires the hose to be exposed to conditions beyond harnessing component specifications.
- Avoid routing harnesses in areas where damage may occur due to build up of material (e.g. dirt, mud, snow, ice, etc.).
- Avoid routing harnesses in areas where the operator or service personnel might step or use as a grab bar.

IMPORTANT: Avoid applying direct spray or pressure washing of electrical components and connections. High pressure streams and sprays can penetrate seals, cause corrosion, or otherwise damage electrical components.
When performing maintenance:

- Inspect electrical components and connectors for corrosion, damaged pins or housings, etc. Repair or replace components or harnessing as necessary.
- Ensure connectors are kept clean and dry. Apply dielectric grease to the sealing surfaces of all connections exposed to moisture, dirt, debris, and other contaminants. Repair or replace harnessing as necessary.
- Clean electrical components with pressurized air, aerosol electrical cleaning agent, or low pressure rinse.
- Remove visible surface water from electrical components and connections using pressurized air or an aerosol cleaning agent. Allow components to dry thoroughly before reconnecting cables.

The following instructions are designed to assist with the proper installation of the VSN® system. Refer to the VSN Calibration & Operation Manual (P/N 016-2020-001) for assistance with calibrating and using the VSN system.



PREPARING FOR INSTALLATION

Before installing the VSN® system, park the machine where the ground is level, clean, and dry. Turn off the machine and leave it turned off for the duration of the installation process.

During the installation process, follow good safety practices. Be sure to carefully read the instructions in this manual to complete the installation process.

PREREQUISITES

The following components must be installed with the VSN® system.

- VSN® version 21.4 or newer
- RS1™ or SC1™/TC1™
- Viper® 4 with ROS version 3.4 or newer

Follow the installation instructions provided with these components before installing the VSN®.

RECOMMENDATIONS

Raven Industries recommends the following best practices when installing or operating the VSN® system for the first time or at the start of the season:

- Install the VSN in the recommended location.
- Use part numbers to help identify parts.
- Do not remove the plastic wrap from a part until it is necessary for installation.

POINT OF REFERENCE

The instructions in this manual assume that you are standing behind the machine, looking toward the cab.

UPDATES

Software and manual updates are available on the Raven Applied Technology website:

<http://www.ravenprecision.com>

At Raven Industries, we strive to make your experience with our products as rewarding as possible. One way to improve this experience is to provide us with feedback on this manual.

Your feedback will help shape the future of our product documentation and the overall service we provide. We appreciate the opportunity to see ourselves as our customers see us and are eager to gather ideas on how we have been helping or how we can do better.

To serve you best, please send an email with the following information to

techwriting@ravenind.com

- VSN® Installation Manual for Challenger MT 7XX/8XX C/D/E
- 016-2023-005 Rev. A
- Any comments or feedback (include chapter or page numbers if applicable).
- Let us know how long you have been using this or other Raven products.

We will not share your email or any information you provide with anyone else. Your feedback is valued and extremely important to us.

Thank you for your time.

KIT CONTENTS

This section contains a list of the components that are included in the VSN® kit. Before beginning the system installation, compare the items in the kit with the components on this list. If you have questions about the kit, contact your Raven dealer.

FIGURE 1. Challenger MT 7XX/8XX C/D/E VSN® Installation kit (P/N 117-2023-005 Rev. A)

QTY	PART #	DESCRIPTION
1	053-0159-087	BOX, SHIPPING
1	115-2020-050	CABLE, VSN, CHALLENGER MT 7XX/8XX C/D/E
1	116-0159-835	WELDMENT, VSN MOUNT, GENERIC
1	116-0159-837	WELDMENT, VSN MOUNT, GENERIC
1	107-0172-642	SHIELD DEBRIS, VSN
1	053-0159-074	ENVELOPE, PLASTIC
4	313-5001-007	GASKET, VITON, .29 ID X .688 OD X .062 THICK
20	313-6000-013N	WASHER, M8,, CLASS V COATING
4	313-6001-013N	WASHER, LOCK, M8, CLASS V COATING
12	311-4055-180N	BOLT, M8-1.25 X 25MM, CLASS V COATING
8	312-6001-027N	NUT, LOCK, M8

FABRICATE THE VSN® BRACKET

1. Assemble the VSN® subassembly as pictured in Figure 1 on page 9 below.

FIGURE 1. VSN® Subassembly

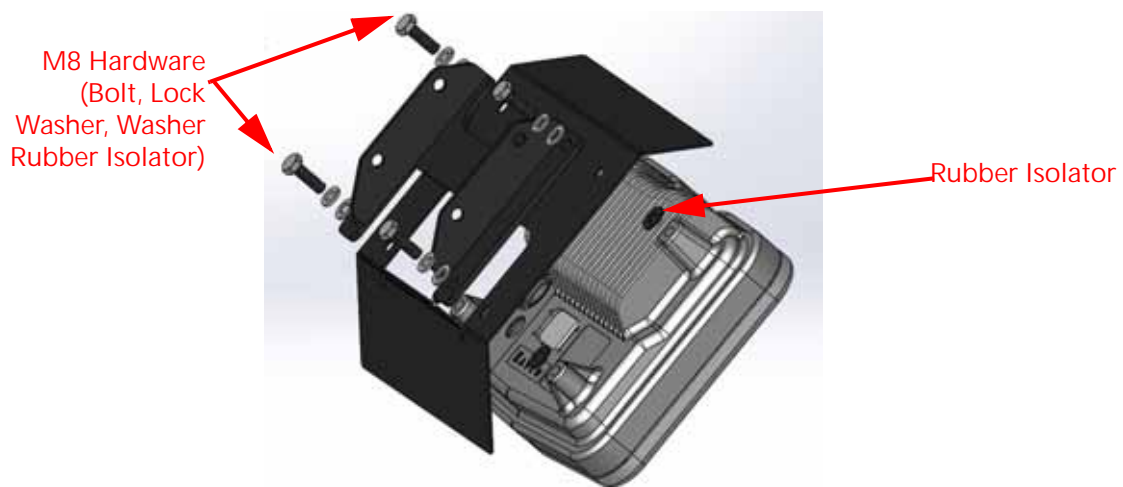

VSN® SPECIFICATIONS

The following sections offer specifications for the VSN (P/N 063-0174-045).

MOUNTING

HEIGHT

- 72" -84" (183-213 cm)
- Measured with the machine level, from the ground to the center of the camera lens

FIGURE 2. Mounting Height Diagram

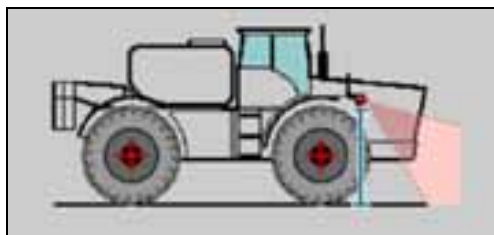

ANGLE

- $45^{\circ} \pm 1^{\circ}$
- Measured with the machine level, in relation to the camera lens and the ground

FIGURE 3. Mounting Angle Diagram

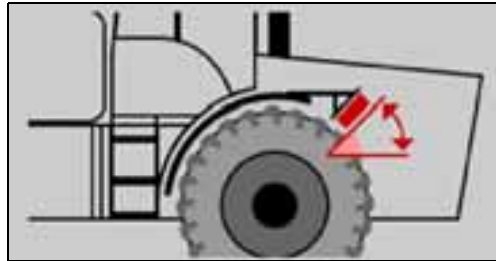

VIEW

- A clear unobstructed view is required
- This can be verified by connecting the video cable to the Viper® 4/4+/CR12. Or on the optional analog display kit (117-2020-007) for CR7™.

FIGURE 4. Field of View Example

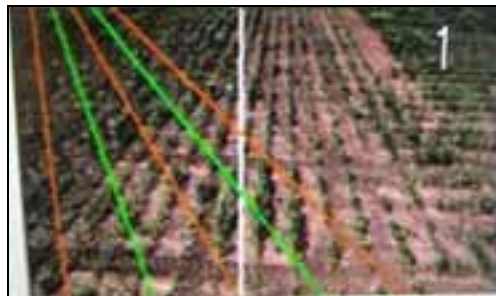

MOUNTING HARDWARE

Mount to a sturdy bracket:

- VSN® weight: 8.6 pounds (3.9 Kg)
- Excess movement of the VSN® unit may result in poor steering performance
- No more than $\pm 1/16"$ (1.6mm) of camera movement, in any direction, throughout full engine RPM range
- Ensure to account for the 23-pin connector and cable in the bracket design

FIGURE 5. Sturdy Mounting Diagram

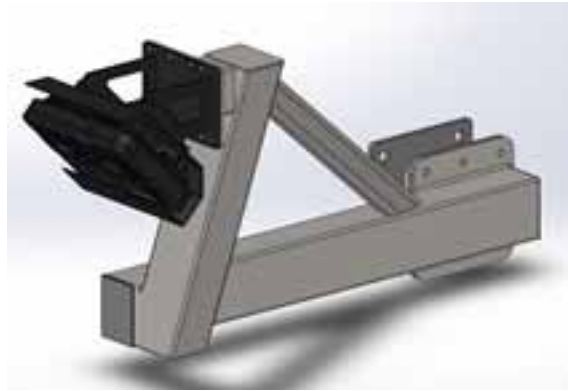
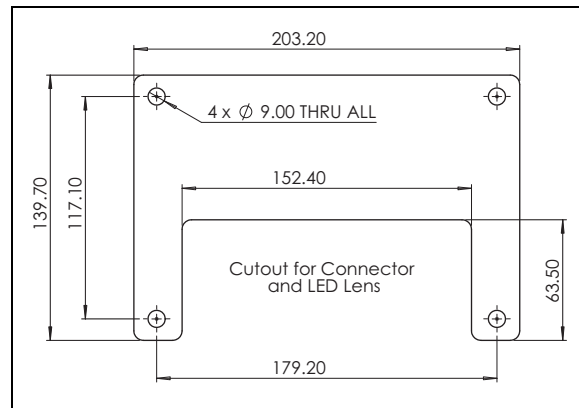

FIGURE 6. VSN® Necessary Bracket Dimensions (mm)



The below hardware is included in the kit.

NOTE: The included mounting bracket can be attached to ensure a 45 degree angle is achieved.

Bolts. M8-1.25 with 13mm of thread engagement into VSN torque to 20 ft-lb (27.1 N-m)

Lock Washers. M8

Flat Washers. M8

Rubber Isolators. 75 Durometer

Debris Shield (required). (P/N 107-0172-642)

Hardware must meet ≥ 750 hours salt fog rating, cannot be stainless steel or Zinc coated and should have an aluminum rich coating.

NOTE: The left/right offset is not important for bracket design since it will be calibrated out. Ideally, the VSN unit should be mounted in the center or left of the tractor hood.

2. Secure the VSN® subassembly to the machine brackets with the included M8 hardware.

FIGURE 7. Installed VSN® (Picture is for reference only)



SYSTEM DIAGRAM

FIGURE 8. Challenger MT 7XX/8XX C/D/E VSN® System Diagram (P/N 054-2023-005)

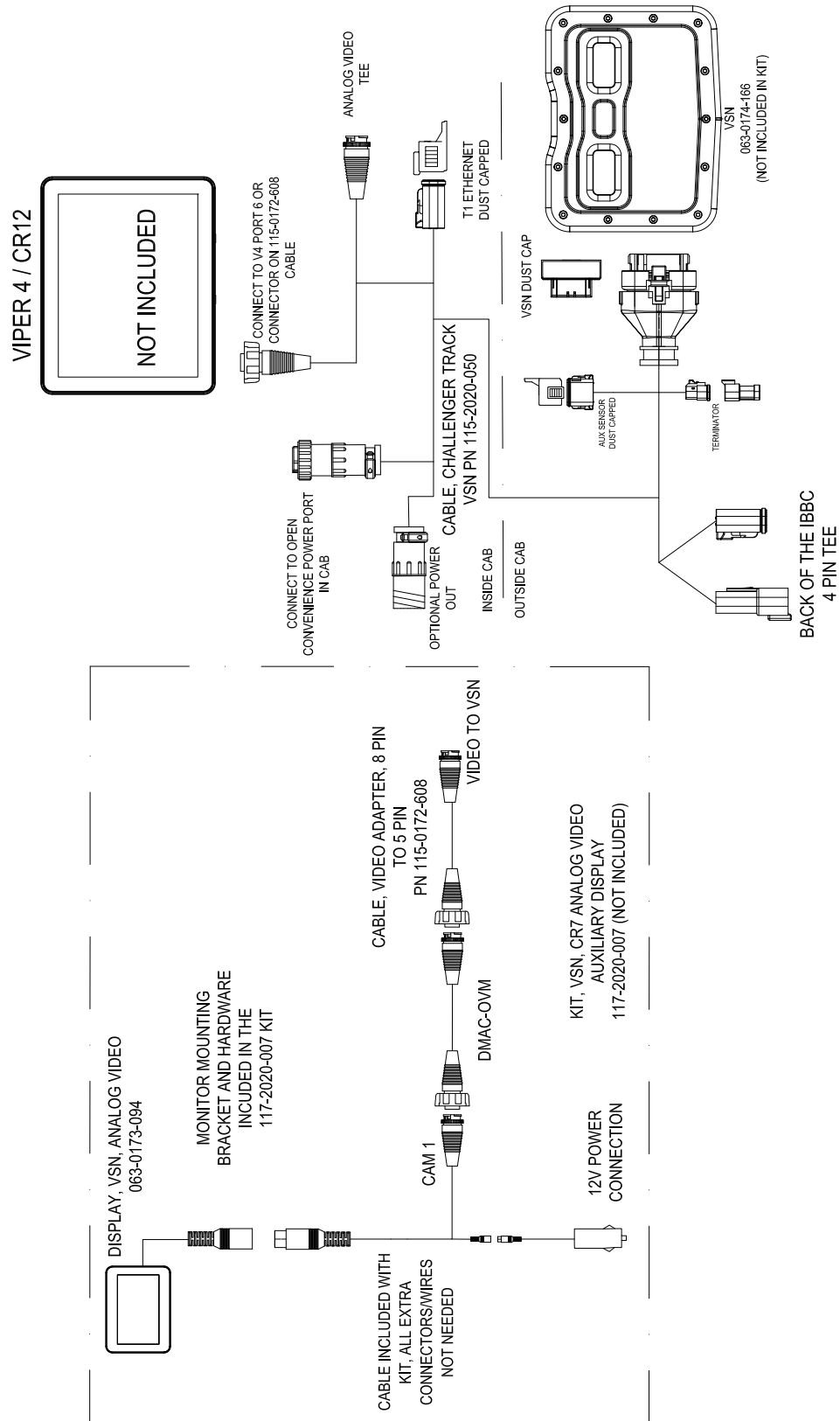

ROUTE THE CABLES

1. Route the VSN® connector on the Challenger MT VSN® cable (P/N 115-2020-050) from the rear of the machine under the cab on the left hand side and follow lines under the hood to the front left side.
2. Plug the VSN® connector into the VSN from below.

FIGURE 9. VSN® Connection



NOTE: Any excess cabling can be secured either under the cab or at the rear of the machine.

3. Connect the two 4-pin ISO connectors at the back of the IBBC connector on the rear of the machine.

FIGURE 10. ISO Connectors



4. Route the remaining connections on the cable into the cab through the rear window.
5. Locate an open convenience port and plug in the connector.
6. Route the analog video cable up to port 6 on the Viper®4 or connect on the 8-pin video adapter cable (P/N 115-0172-608) on the optional analog video display.

FIGURE 11. Viper® 4 Connection



INSTALL THE (OPTIONAL) ANALOG VIDEO KIT

If a CR7™ is used in the machine, the analog video kit (P/N 117-2020-007) may be useful for viewing the video feed from VSN®. The CR7™ does not have an analog video input, so this auxiliary display is used.

FIGURE 12. Standalone Height Sensor

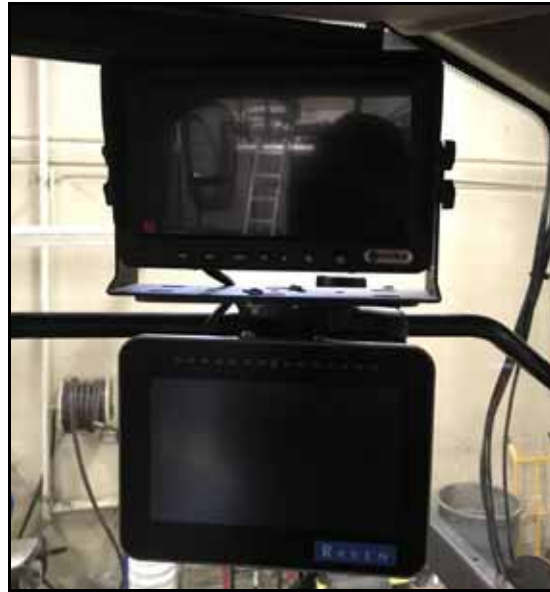

MOUNT THE ANALOG DISPLAY TO CR7™

1. Remove the screws securing the RAM mount on the rear of the CR7.
2. Using the washers provided, place a washer between the CR7 and the bracket.
3. Place a washer on the back of the bracket and use the existing screws that held the RAM mount in place.

IMPORTANT: Two washers are used on each of the CR7 screws to ensure proper length. Torque between 9 and 11 in-lbs.

4. Using the additional hardware, mount the RAM mount to the bracket.
5. Mount the auxiliary display bracket to the bracket as seen in Figure 16.

FIGURE 13. Mounted to Bracket



NOTE: Larger RAM connectors and mounts are provided to account for the extra weight.

CABLING

1. Using the power adapter provided, connect to the provided cabling for the display.
2. Plug the cabling into an open 12 V power connection.
3. Plug in the display.
4. Use the CAM 1 connection and the DMAC-OWM cable (P/N 115-2020-041) to adapt the 8-pin video adapter cable (P/N 115-0172-608).
5. Connect the analog video feed from the VSN®.

NOTE: The trigger wires and other camera inputs will not be used.

If desired, more cameras may be purchased and plugged into the other camera inputs on this display.

SYSTEM DIAGRAM

The system diagram for the VSN® analog video system can be found on the next page.

FIGURE 14. (Optional) VSN® Analog Video System Diagram (P/N 054-2020-003 Rev. A)

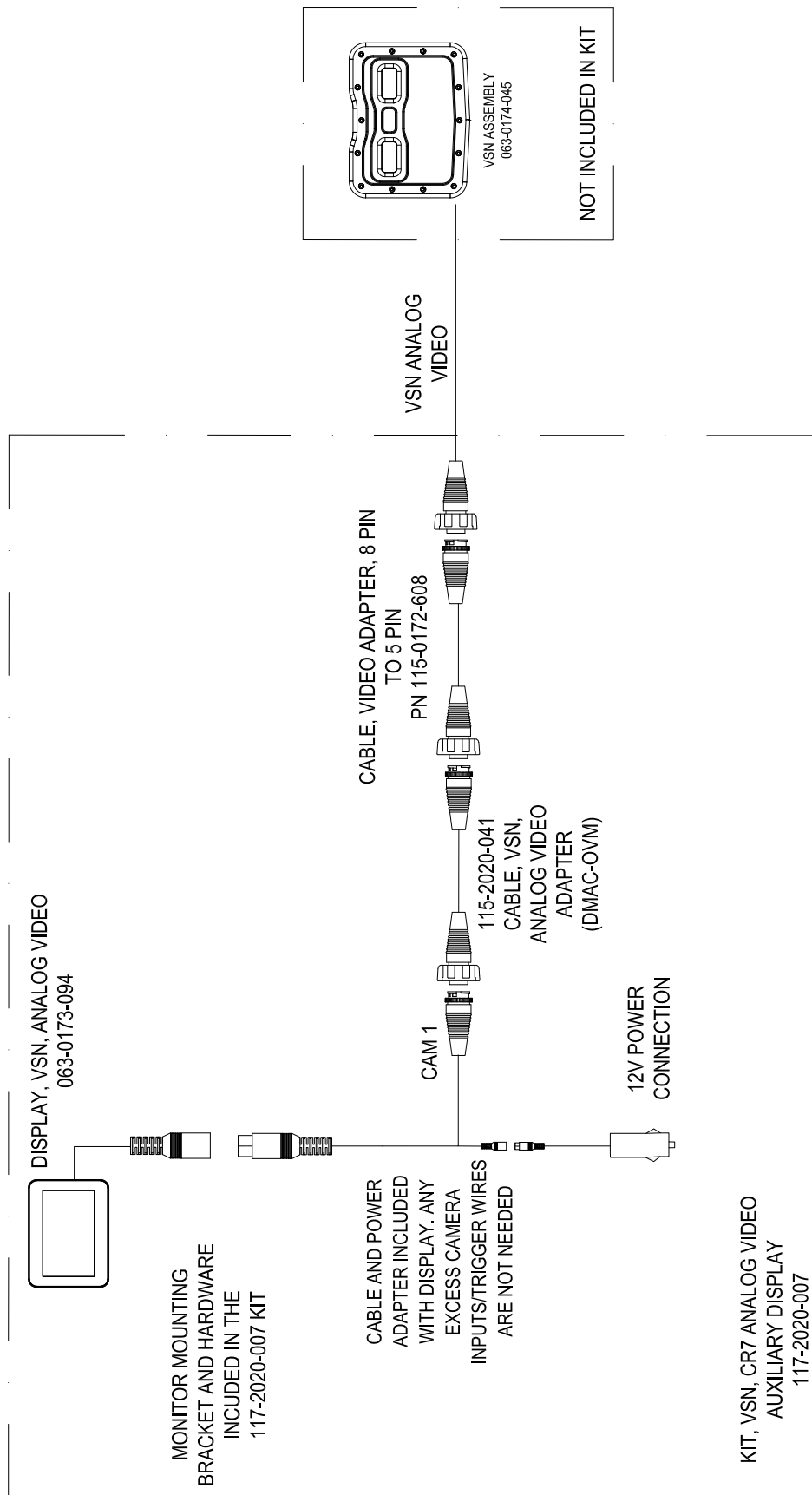

LIMITED WARRANTY

WHAT DOES THIS WARRANTY COVER?

This warranty covers all defects in workmanship or materials in your Raven Applied Technology Division product under normal use, maintenance, and service when used for intended purpose.

HOW LONG IS THE COVERAGE PERIOD?

Raven Applied Technology products are covered by this warranty for 12 months from the date of retail sale. In no case will the Limited Warranty period exceed 36 months from the date the product was issued by Raven Industries Applied Technology Division. This warranty coverage applies only to the original owner and is non-transferable.

HOW CAN I GET SERVICE?

Bring the defective part and proof of purchase to your Raven dealer. If the dealer approves the warranty claim, the dealer will process the claim and send it to Raven Industries for final approval. The freight cost to Raven Industries will be the customer's responsibility. The Return Materials Authorization (RMA) number must appear on the box and all documentation (including completed RMA form, Certificate of Decontamination, and retail proof of purchase) must be included inside the box to be sent to Raven Industries.

WHAT WILL RAVEN INDUSTRIES DO?

Upon confirmation of the warranty claim, Raven Industries will (at our discretion) repair or replace this product or any component of the product found to be defective during the warranty period. Replacement will be made with a new or remanufactured product or component. Standard return freight will be paid, regardless of inbound shipping method. Expedited freight is available at the customer's expense.

WHAT IS NOT COVERED BY THIS WARRANTY?

Raven Industries will not assume any expense or liability for repairs outside our facility without written consent. Raven Industries is not responsible for damage to any associated equipment or products and will not be liable for loss of profit, labor, or other damages. The obligation of this warranty is in lieu of all other warranties, expressed or implied, and no person or organization is authorized to assume any liability for Raven Industries.

- Damages caused by normal wear and tear, misuse, abuse, neglect, accident, improper installation and maintenance are not covered by this warranty.
- Worn/Chafed hoses and cables.
- Items in contact with fluids and chemicals including seals and O-rings.
- Software downloads and updates.
- Tamper-Evident label broken or customer disassembly.
- Any customer modification to the original product outside normal calibration and adjustments, without written approval.
- Intentional modification to cables.
- Failures due to lack of cleaning or preventive maintenance, and any condition, malfunction or damage not resulting from defects in material or workmanship.
- Items in contact with fluids or chemicals, returned without proper cleaning, decontamination and documentation.

EXTENDED WARRANTY

WHAT DOES THIS WARRANTY COVER?

This warranty covers all defects in workmanship or materials in your Raven Applied Technology Division product under normal use, maintenance, and service when used for intended purpose.

DO I NEED TO REGISTER MY PRODUCT TO QUALIFY FOR THE EXTENDED WARRANTY?

Yes. Products/systems must be registered within 30 days of retail sale to receive coverage under the Extended Warranty. If the component does not have a serial tag, the kit it came in must be registered instead.

WHERE CAN I REGISTER MY PRODUCT FOR THE EXTENDED WARRANTY?

To register, go online to www.portal.ravenprecision.com and select Product Registration.

HOW LONG IS THE EXTENDED WARRANTY COVERAGE PERIOD?

Raven Applied Technology products that have been registered online are covered for an additional 12 months beyond the Limited Warranty for a total coverage period of 24 months from the date of retail sale. In no case will the Extended Warranty period exceed 36 months from the date the product was issued by Raven Industries Applied Technology division. This Extended Warranty coverage applies only to the original owner and is non-transferable.

HOW CAN I GET SERVICE?

Bring the defective part and proof of purchase to your Raven dealer. If the dealer approves the warranty claim, the dealer will process the claim and send it to Raven Industries for final approval. The freight cost to Raven Industries will be the customer's responsibility. The Return Materials Authorization (RMA) number must appear on the box and all documentation (including completed RMA form, Certificate of Decontamination, and Extended Warranty Registration Number) must be included inside the box to be sent to Raven Industries. In addition, the words "Extended Warranty" must appear on the box and all documentation if the failure is between 12 and 24 months from the retail sale.

WHAT WILL RAVEN INDUSTRIES DO?

Upon confirmation of the warranty claim, Raven Industries will (at our discretion) repair or replace this product or any component of the product found to be defective during the warranty period. Replacement will be made with a new or remanufactured product or component. Standard return freight will be paid, regardless of inbound shipping method. Expedited freight is available at the customer's expense.

WHAT IS NOT COVERED BY THE EXTENDED WARRANTY?

Raven Industries will not assume any expense or liability for repairs outside our facility without written consent. Raven Industries is not responsible for damage to any associated equipment or products and will not be liable for loss of profit, labor, or other damages. The obligation of this warranty is in lieu of all other warranties, expressed or implied, and no person or organization is authorized to assume any liability for Raven Industries.

- Damages caused by normal wear and tear, misuse, abuse, neglect, accident, improper installation and maintenance are not covered by this warranty.
- Worn/Chafed hoses and cables.
- Items in contact with fluids and chemicals including seals and O-rings.
- Software downloads and updates.
- Tamper-Evident label broken or customer disassembly.
- Any customer modification to the original product outside normal calibration and adjustments, without written approval.
- Intentional modification to cables.
- Failures due to lack of cleaning or preventive maintenance, and any condition, malfunction or damage not resulting from defects in material or workmanship.
- Items in contact with fluids or chemicals, returned without proper cleaning, decontamination and documentation.