

SYSTEM DRAWING, HAWKEYE 2, FAST PULL TYPE SPRAYERS, MY21+

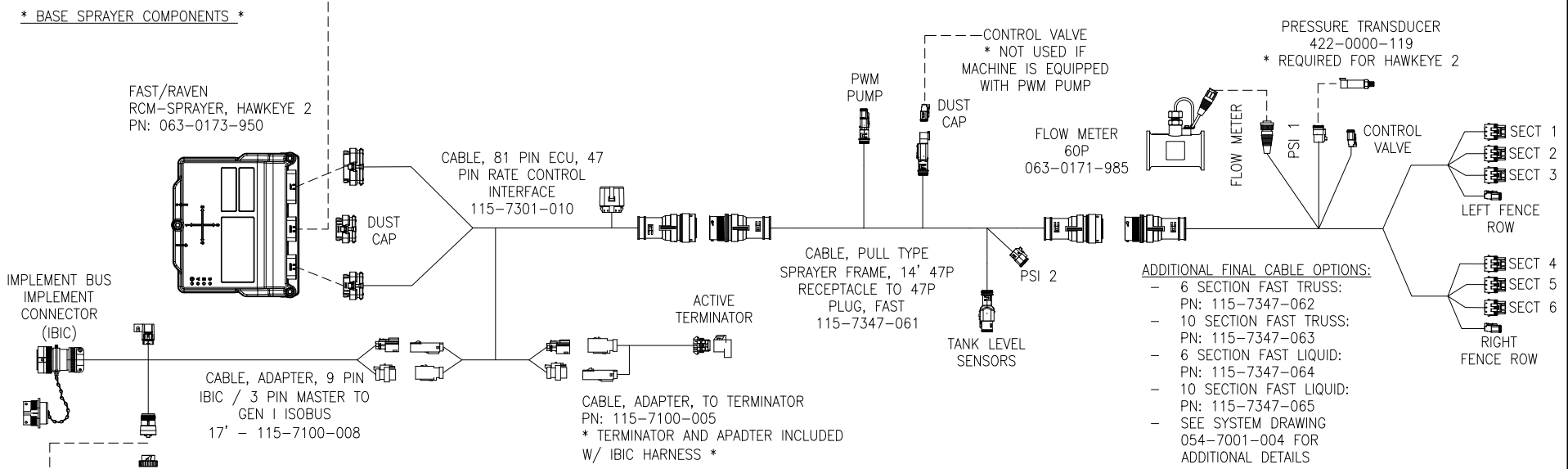
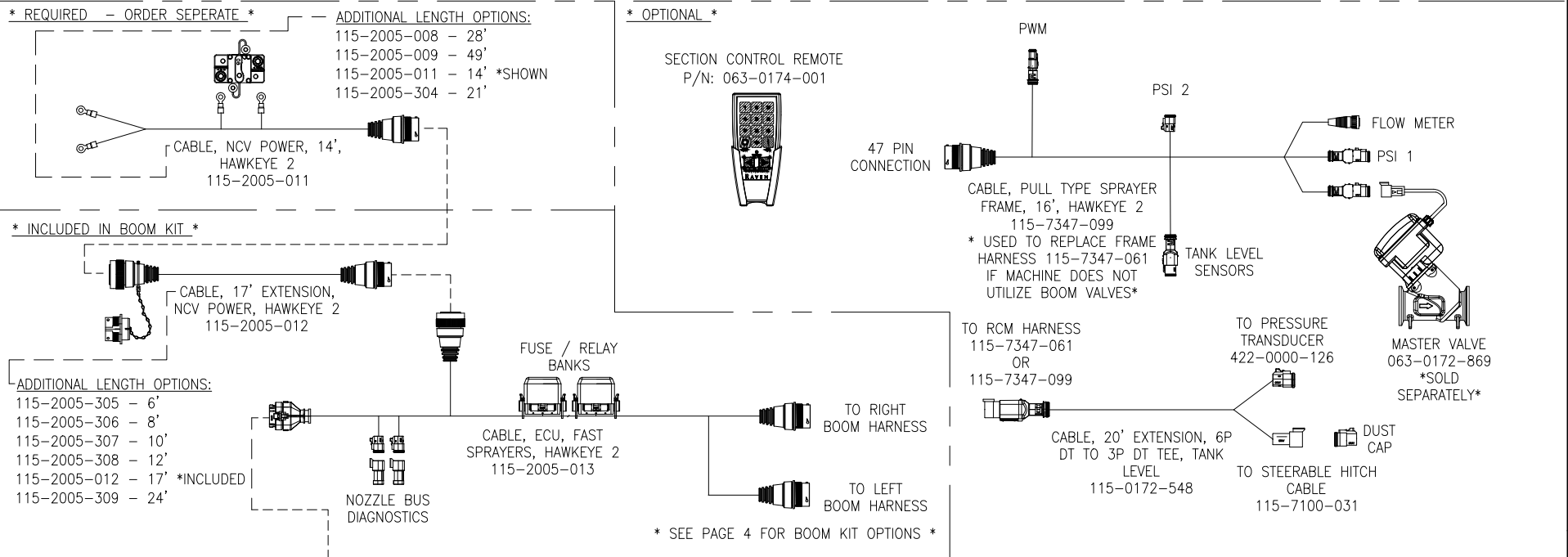

RELEASED DATE	ECO #	REV.	DRAWING NO.
1/11/21	36528	B	054-2005-005
8/19/21	37743	C	054-2005-005

SYSTEM DRAWING, HAWKEYE 2, FAST 3 POINT SPRAYERS, MY21+

* REQUIRED - ORDER SEPERATE *

* INCLUDED IN BOOM KIT *

* OPTIONAL *

SECTION CONTROL REMOTE
P/N: 063-0174-001

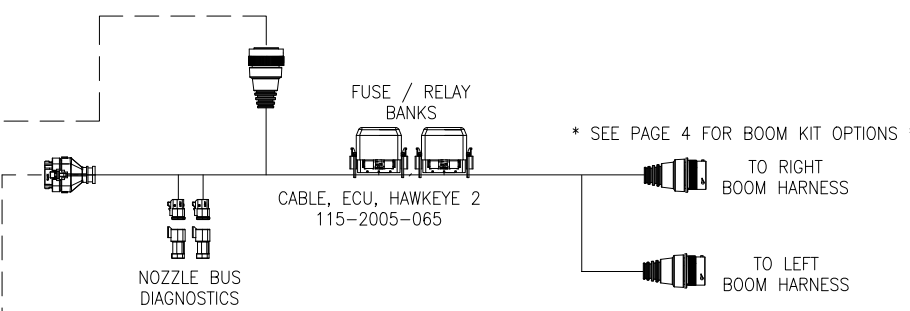
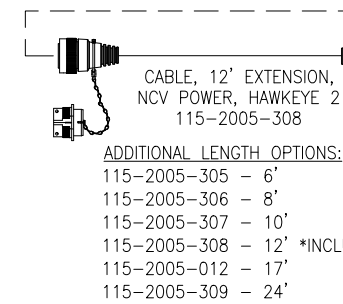
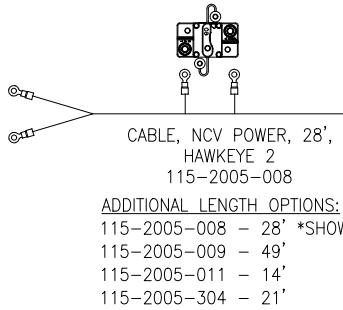

* BASE SPRAYER COMPONENTS *

FAST/RAVEN
RCM-SPRAYER, HAWKEYE 2
PN: 063-0173-950

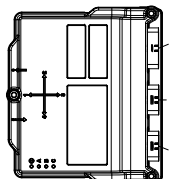

CABLE, 81 PIN ECU, 47
PIN RATE CONTROL
INTERFACE
115-7301-010



IMPLEMENT BUS
IMPLEMENT
CONNECTOR
(IBIC)

CABLE, ADAPTER, 9 PIN
IBIC / 3 PIN MASTER TO
GEN I ISOBUS
17' - 115-7100-008

ACTIVE
TERMINATOR

CABLE, ADAPTER, TO TERMINATOR
PN: 115-7100-005
* TERMINATOR AND APADTER
INCLUDED W/ IBIC HARNESS *

PRESSURE TRANSDUCER
422-0000-119
* REQUIRED FOR HAWKEYE 2

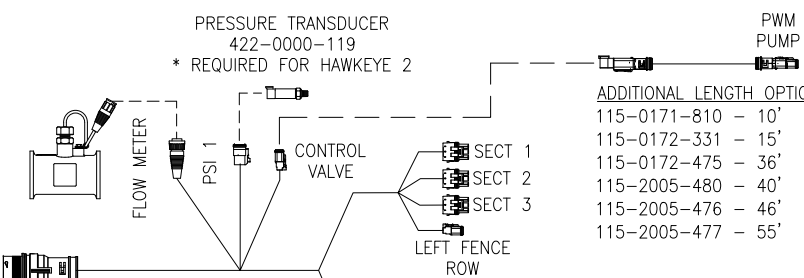

ADDITIONAL LENGTH OPTIONS:
115-0171-810 - 10'
115-0172-331 - 15'
115-0172-475 - 36'
115-2005-480 - 40'
115-2005-476 - 46'
115-2005-477 - 55'

ADDITIONAL FINAL CABLE OPTIONS:
- 6 SECTION FAST TRUSS:
PN: 115-7347-062
- 10 SECTION FAST TRUSS:
PN: 115-7347-063
- 6 SECTION FAST LIQUID:
PN: 115-7347-064
- 10 SECTION FAST LIQUID:
PN: 115-7347-065
- SEE SYSTEM DRAWING
054-7001-004 FOR
ADDITIONAL DETAILS

TO CAB MASTER SWITCH
* SEE PAGE 3 FOR MASTER
SWITCH OPTIONS

RELEASED DATE	ECO #	REV.	DRAWING NO.
1/11/21	36528	B	054-2005-005
8/19/21	37743	C	054-2005-005

RAVEN MASTER SWITCH OPTIONS

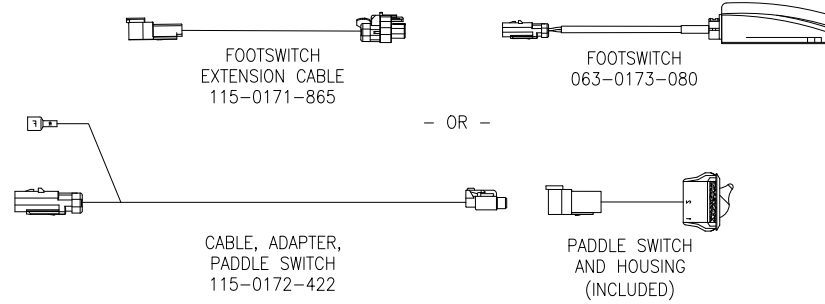

FAST ISO SWITCHBOX (120' AND 132' BOOM ONLY)
PN: 063-0173-745

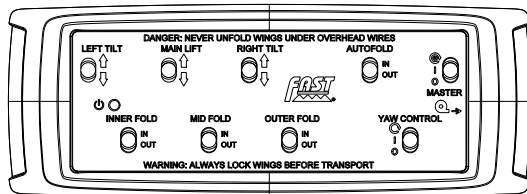

117-6020-005
KIT, RAVEN ISOBUS
SWITCHBOX, FAST FOLD

* SOFTWARE VERSION V1.0.1.4 OR
HIGHER REQUIRED FOR PRODUCT
MASTER SWITCH FUNCTIONALITY

ISO SWITCHBOX (STAND-ALONE)
PN: 117-6020-001

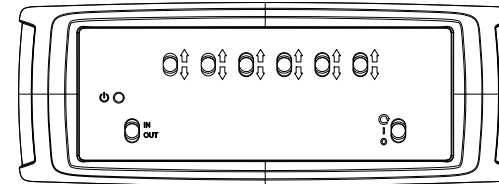

- AVAILABLE KITS:
- FOR USE WITH RAVEN VIPER 4(+) 117-6020-004
 - FOR USE WITH RAVEN CR7 117-2295-051
 - FOR USE WITH DEERE GS2630 117-6020-002
 - FOR USE WITH CNH PRO 700/INTELLVIEW 117-6020-003

* SWITCHBOXES CAN BE COMBINED TO PROVIDE PHYSICAL SWITCHES IF DESIRED
** TO STACK SWITCHBOXES:
107-0172-322 PLATE, STACK
115-0171-364: CABLE, CAN TEE 6"

*OPTIONAL – AUXILIARY ISOBUS DISPLAY

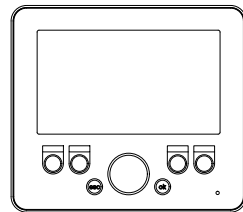
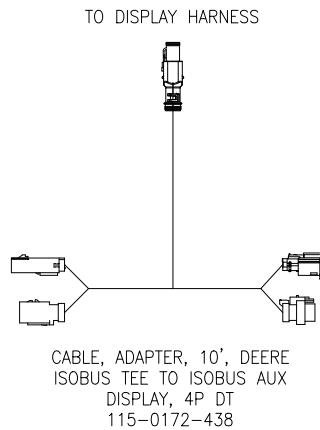

- * KIT PN: 117-0171-702
CONTAINS DISPLAY, MOUNTING
BRACKET, AND DISPLAY
HARNESS
- * CONSOLE, ISOBUS
AUXILIARY 4.3" DISPLAY
PN: 063-0173-938
- * OPTIONAL RAM MOUNT KIT
PN: 117-0171-709

*OPTIONAL – AUXILIARY SENSORS

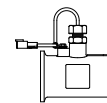

- TANK FILL FLOW METER KIT:
P/N: 117-0171-703
*CONTAINS FLOW METER, MOUNTING HARDWARE, AND FLOW
METER HARNESS



- PRESSURE TRANSDUCER:
P/N: 422-0000-119
*USE FOR PRESSURE 2 (SPARGE) IF APPLICABLE
*USE CABLE 115-0172-278

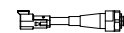

- TANK LEVEL PRESSURE TRANSDUCER:
P/N: 422-0000-126
NOTE SENSOR ALREADY INSTALLED IF EQUIPPED WITH
STEERABLE HITCH, USE TEE CABLE P/N: 115-0172-548

RELEASED DATE	ECO #	REV.	DRAWING NO.
1/11/21	36528	B	054-2005-005
8/19/21	37743	C	054-2005-005

SYSTEM DRAWING, HAWKEYE 2, FAST SPRAYERS, MY21+

SYSTEM DESCRIPTION	NCV TOTAL	CABLE, INNER RIGHT	CABLE, INNER LEFT	CABLE, MID	CABLE, OUTER
117-2005-039 - KIT, HAWKEYE 2, FAST 973PT, MY21+, 120'/20" BOOM, TEEJET	72	115-2005-323	115-2005-323	115-2005-169	115-2005-098
117-2005-040 - KIT, HAWKEYE 2, FAST 9500TF, MY21+, 90'/20" BOOM, TEEJET	54	115-2005-096	115-2005-096	115-2005-097	115-2005-098
117-2005-041 - KIT, HAWKEYE 2, FAST 9600N, MY21+, 90'/20" BOOM, TEEJET	54	115-2005-099	115-2005-099	115-2005-097	115-2005-098
117-2005-042 - KIT, HAWKEYE 2, FAST 9500TF, MY21+, 100'/20" BOOM, TEEJET	60	115-2005-168	115-2005-168	115-2005-169	115-2005-098
117-2005-043 - KIT, HAWKEYE 2 FAST, MY21+, 120'/20" BOOM, TEEJET	72	115-2005-166	115-2005-166	115-2005-167	115-2005-098
117-2005-044 - KIT, HAWKEYE 2 FAST, MY21+, 120'/15" BOOM, TEEJET	97	115-2005-170	115-2005-171	115-2005-172	115-2005-173
117-2005-045 - KIT, HAWKEYE 2, FAST, MY21+, 132'/22" BOOM, TEEJET	72	115-2005-174	115-2005-174	115-2005-175	115-2005-176
117-2005-046 - KIT, HAWKEYE 2, FAST 9500TF, MY21+, 90'/15" BOOM, TEEJET	73	115-2005-207	115-2005-208	115-2005-209	115-2005-210
117-2005-047 - KIT, HAWKEYE 2, FAST 9600N, MY21+, 90'/15" BOOM, TEEJET	73	115-2005-211	115-2005-212	115-2005-209	115-2005-210
117-2005-048 - KIT, HAWKEYE 2, FAST, MY21+, 80'/15" BOOM, TEEJET	65	115-2005-207	115-2005-208	115-2005-216	115-2005-217
117-2005-049 - KIT, HAWKEYE 2, FAST, MY21+, 80'/20" BOOM, TEEJET	48	115-2005-168	115-2005-168	115-2005-218	115-2005-219
117-2005-206 - KIT, HAWKEYE 2, FAST 973PT, MY21+, 120'/15" BOOM, TEEJET	97	115-2005-325	115-2005-324	115-2005-326	115-2005-217
117-2005-207 - KIT, HAWKEYE 2, FAST 973PT, MY21+, 132'/22" BOOM, TEEJET	72	115-2005-327	115-2005-327	115-2005-175	115-2005-328
117-2005-208 - KIT, HAWKEYE 2, FAST, MY21+, 88'/22" BOOM, TEEJET	48	115-2008-012	115-2008-012	NA	115-2008-013
UNLOCK - HAWKEYE PREMIUM PN: 077-0180-284	1	NA	NA	NA	NA

- NOTES:
 1. NOT ALL CONNECTIONS SHOWN
 2. NCV, HAWKEYE 2, TEEJET
 PN: 063-2005-001
 3. KIT, SYSTEM SERVICE, HAWKEYE 2,
 TEEJET
 PN: 117-2005-050

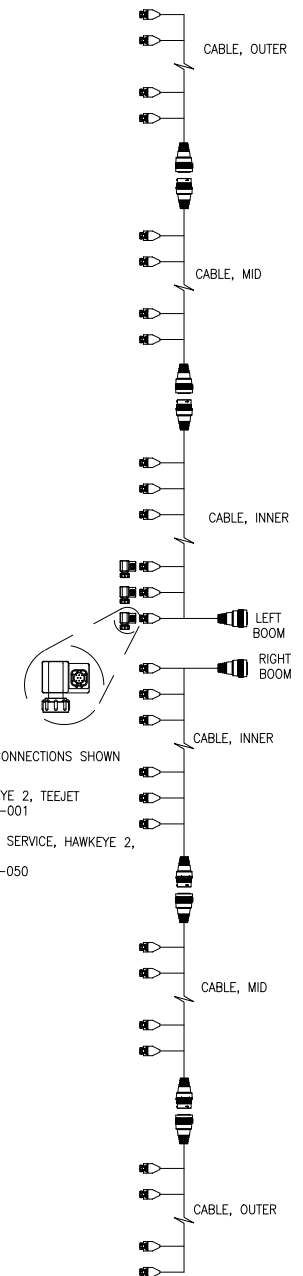

RELEASED DATE	ECO #	REV.	DRAWING NO.
1/11/21	36528	B	054-2005-005
8/19/21	37743	C	054-2005-005