

SYSTEM DRAWING, RAVEN READY TO CR12, RS1, W/O IBBC

CONSOLE, CR12, UT UNLOCK
 117-2300-001/005
 CONSOLE, V4+, UT UNLOCK
 117-5010-068/069

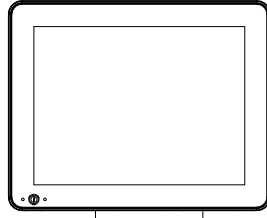

KIT, RS1
 117-5001-037/041

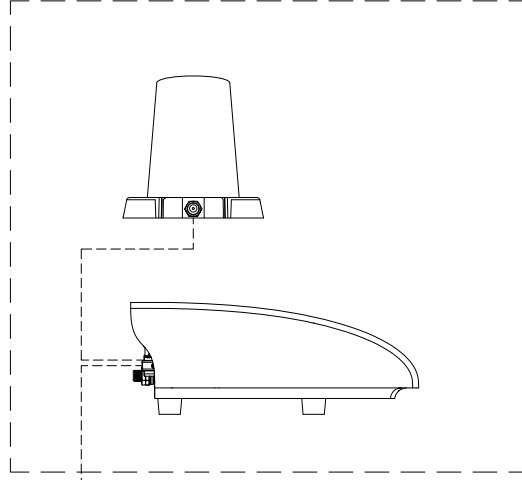

RAVEN CAN

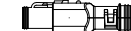

AUX ISOBUS



115-8000-376



SLINGSHOT
 MODEM
 POWER

MODEM
 POWER



CAN BUS
 TERMINATION

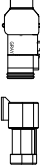

3D GPS OUT/
 RADAR OUT



RTK CORR



115-8000-330

CAN2 LOOP



CAN2 LOOP

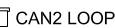

KIT, RAVEN READY
 TO CR12, RS1 W/O
 IBBC
 117-8000-426

HDU
 063-0173-887

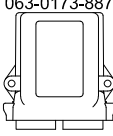

115-8000-394

VALVE



WAS

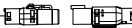

PRESSURE
 SENSOR

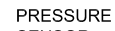

115-8000-377

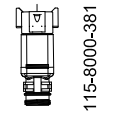

SAFETY HOMOLOGATION KIT
 SEE 054-8000-462

FUSE, 10A



BATTERY GND

BATTERY 12V

CAN BUS
 TERMINATION



115-8000-141

RELAY, 40A



RELAY, 40A



FUSE, 5A



FUSE, 15A



RELEASED DATE	ECO #	REV.	DRAWING NO.
11/16/20	36167	A	054-8000-426