

RAVEN ISO AUTOBOOM WITH RAVEN ISO RATE CONTROL

REPEAT AS NEEDED FOR EACH ADDITIONAL RAVEN ISOBUS ECU

ORDER SEPARATELY, CABLE SHOULD REACH FROM ECU OR TEE TO 3' IN FRONT OF HITCH MINIMUM

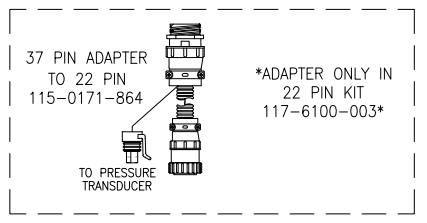
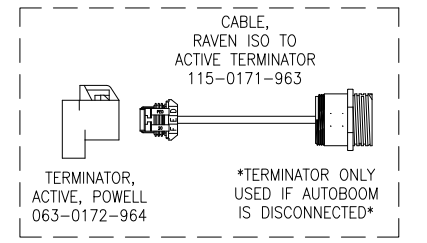
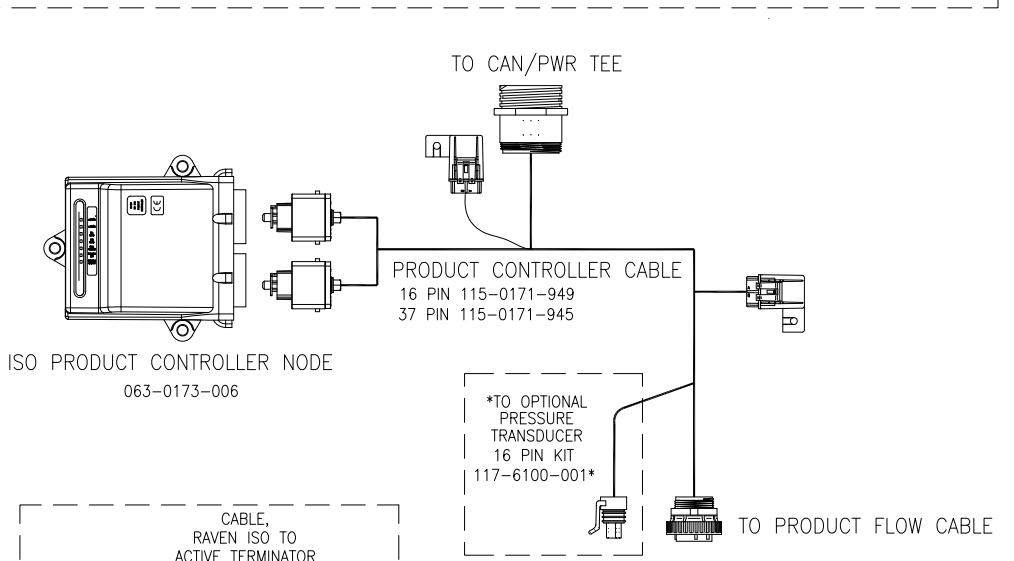
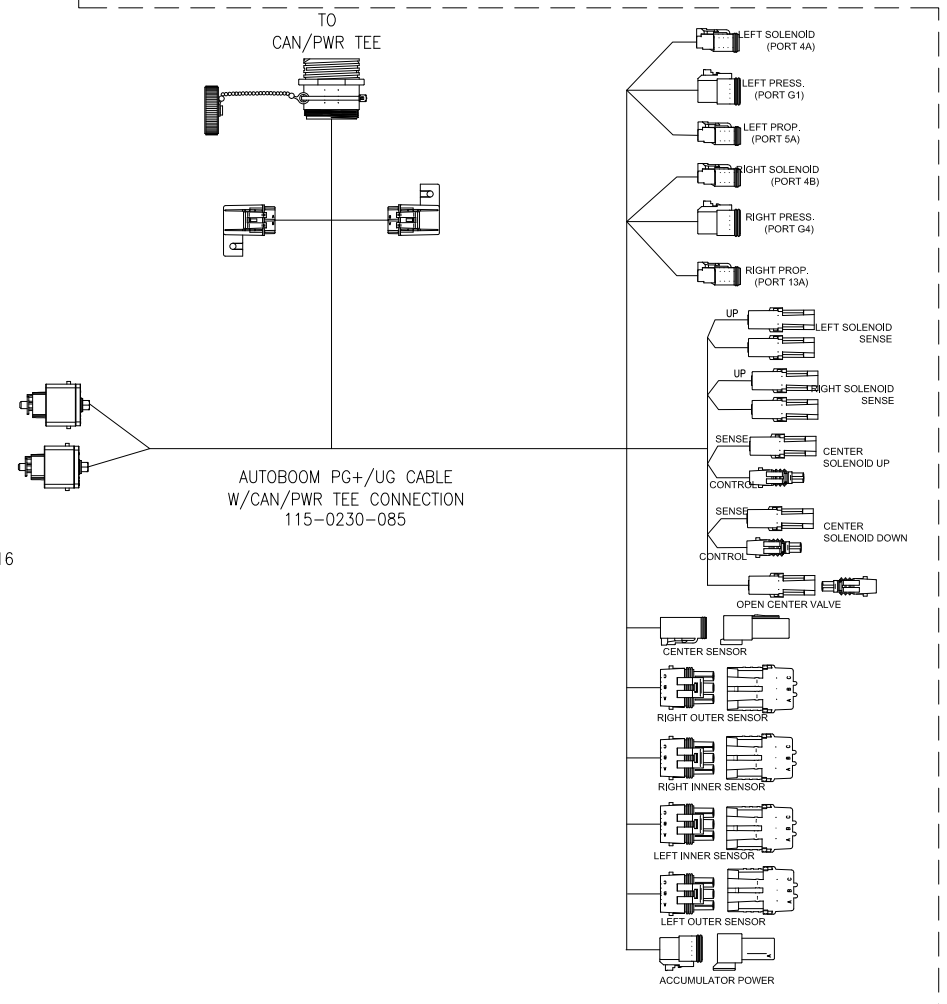
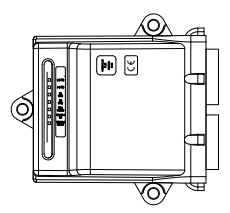
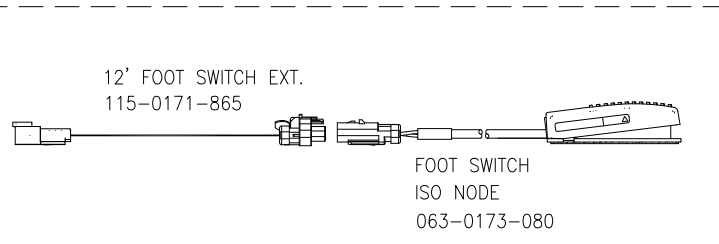
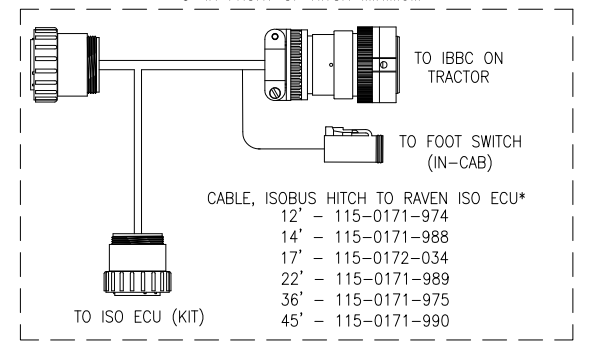
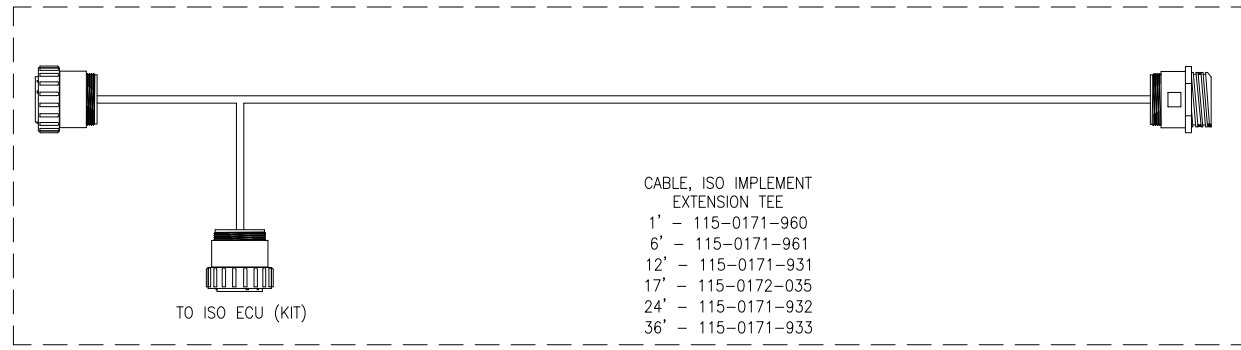
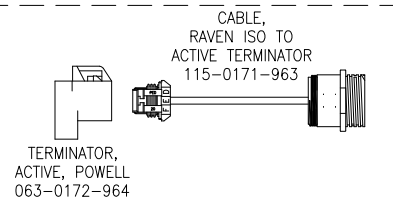

ISO PRODUCT CONTROLLER KIT,
 LIQUID 16 PIN 117-6100-001
 LIQUID 37 PIN 117-6100-002
 LIQUID/GRAN 22 PIN 117-6100-003

ISO AUTOBOOM KIT:
 117-0137-037 OR
 117-0137-041

RELEASED DATE	ECO NO.	PROD. MGR.	SERV.	PROD. CHAMP.	ENG.	DRAFT.	REV.	DRAWING NO.
3/31/11	E17401	BDB	TAC	ADA	NOM	MAP	C	054-2430-003
8/6/15	24322	TPH	-	JCS	RKM	RRS	D	054-2430-003