

R A V E N

OmniRow™ Installation Manual



Case IH Sectional

Disclaimer

While every effort has been made to ensure the accuracy of this document, Raven Industries assumes no responsibility for omissions and errors. Nor is any liability assumed for damages resulting from the use of information contained herein.

Raven Industries shall not be responsible or liable for incidental or consequential damages or a loss of anticipated benefits or profits, work stoppage or loss, or impairment of data arising out of the use, or inability to use, this system or any of its components. Raven Industries shall not be held responsible for any modifications or repairs made outside our facilities, nor damages resulting from inadequate maintenance of this system.

As with all wireless and satellite signals, several factors may affect the availability and accuracy of wireless and satellite navigation and correction services (e.g. GPS, GNSS, SBAS, etc.). Therefore, Raven Industries cannot guarantee the accuracy, integrity, continuity, or availability of these services and cannot guarantee the ability to use Raven systems, or products used as components of systems, which rely upon the reception of these signals or availability of these services. Raven Industries accepts no responsibility for the use of any of these signals or services for other than the stated purpose.

Chapter 1	<i>Important Safety Information</i>	1
Hydraulic Safety	2
Electrical Safety	2
Chapter 2	<i>Introduction</i>	3
Preparing for Installation	3
Recommendations	3
Tools Needed	4
Point of Reference	4
Hydraulic Fittings	4
Chapter 3	<i>Hydraulic System Installation</i>	5
Preparing for Installation	5
Disassemble the Planter's Drive System	6
Install the OmniRow Hydraulic Motors	9
Install the Fittings on the PWM Valve	9
Install the PWM Valve and Fittings on the OmniRow Hydraulic Motor	11
Mount the OmniRow Hydraulic Motors	11
Install the Pressure Gauge Test Kit	14
Install the OmniRow Hydraulic Valve	14
Install the Fittings on the Valve	15
Mount the OmniRow Hydraulic Valve	16
Install the Planter Row Unit Pressure and Tank Hoses	17
Install the OmniRow Valve Pressure and Tank Hoses	19
Connect the Hydraulic Hoses to the Tractor	20
Open Center Hydraulic System	20
Closed Center Hydraulic System	21
Chapter 4	<i>Wiring Installation</i>	23
Install the Tractor Cables	23
Install the Seed Tube Sensors	24
Install the OmniRow Harness Cables	24
Install the Proximity Switch	26
Install the OmniRow Node	27
System Installation Verification	27

CHAPTER

1

Important Safety Information

NOTICE

Read this manual and the operation and safety instructions included with your implement and/or controller carefully before installing the OmniRow™ system.

- Follow all safety information presented within this manual.
- If you require assistance with any portion of the installation or service of your Raven equipment, contact your local Raven dealer for support.
- Follow all safety labels affixed to the OmniRow system components. Be sure to keep all safety labels in good condition and replace any missing or damaged labels. To obtain replacements for missing or damaged safety labels, contact your local Raven dealer for support.

When operating the machine after installing OmniRow, observe the following safety measures:

- Be alert and aware of surroundings.
- Do not operate OmniRow or any agricultural equipment while under the influence of alcohol or an illegal substance.
- Remain in the operator's position in the machine at all times when OmniRow is engaged.
- Disable OmniRow when exiting from the operator's seat and machine.
- Do not drive the machine with OmniRow enabled on any public road.
- Determine and remain a safe working distance from other individuals. The operator is responsible for disabling OmniRow when the safe working distance has diminished.
- Ensure OmniRow is disabled prior to starting any maintenance work on OmniRow or the machine.

WARNING

- When starting the machine for the first time after installing OmniRow, be sure that all persons stand clear, in case a hose has not been properly tightened.
- Install the enclosed warning labels in a highly-visible area of the planter's tool bar.

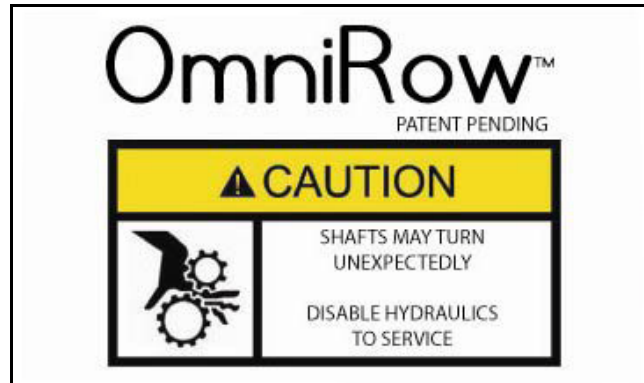

CAUTION

Hydraulic Safety

- Raven Industries recommends that appropriate protective equipment be worn at all times when working on the hydraulic system.
- Never attempt to open or work on a hydraulic system with the equipment running. Care should always be taken when opening a system that has been previously pressurized.
- When disconnecting the hydraulic hoses or purging is required, be aware that the hydraulic fluid may be extremely hot and under high pressure. Caution must be exercised.
- Any work performed on the hydraulic system must be done in accordance with the machine manufacturer's approved maintenance instructions.
- When installing OmniRow hydraulics or performing diagnostics, maintenance, or routine service, ensure that precautions are taken to prevent any foreign material or contaminants from being introduced into the machine's hydraulic system. Objects or materials that are able to bypass the machine's hydraulic filtration system will reduce performance and possibly damage the hydraulic valves.

Electrical Safety

- Always verify that the power leads are connected to the correct polarity as marked. Reversing power leads could cause severe damage to the equipment.
- Ensure that the power cable is the last cable to be connected.

Congratulations on your purchase of the Raven OmniRow system! This system is designed to allow you to manage variable-rate seeding, automatic on/off planter control, and real-time seed monitoring, eliminating costly skips, doubles, and over-plants.

This manual applies to various Case IH planters equipped with standard Case IH row units and options.

Preparing for Installation

Before installing OmniRow, park the machine on a level, clean, and dry surface. Leave the machine turned off for the duration of the installation process.

During the installation process, follow good safety practices. Be sure to carefully read the instructions in this manual as you complete the installation process.

Recommendations

Raven Industries recommends the following best practices before installing or operating the OmniRow system for the first time, at the start of the season, or when moving the OmniRow system to another machine:

- Ensure the machine's hydraulic filters have been recently changed and there are no issues with the machine's hydraulic system (e.g., pump issues, faulty hydraulic motors, fine metal deposits in the hydraulic hoses, etc.).
- Cycle the planter's folding operations to ensure that hoses are not rubbing on or interfering with moving parts and hydraulic fluid is not leaking from the system.
- If the planter is equipped with row cleaners/coulters, verify travel of row cleaners/coulters do not interfere with the OmniRow equipment.

Raven Industries recommends the following best practices when installing the OmniRow system.

- Use part numbers to identify the parts.
- Do not remove the plastic wrap from a part until it is necessary for installation.
- Do not remove plastic caps from a part until it is necessary for installation.

Tools Needed

The following tools are recommended for installation of the OmniRow system:

- SAE standard-sized wrenches/sockets
- Metric wrenches/sockets
- Allen wrenches
- Cable ties
- Set of tools

Point of Reference

The instructions in this manual assume that you are standing behind the planter, looking toward the planter's hitch or tractor. The planter row units referenced in the manual are numbered from left to right, with the left row unit being #1.

Hydraulic Fittings

This manual may reference the following types of hydraulic fittings:

- SAE O-Ring fittings
- ORFS (O-Ring Face Seal) fittings
- JIC fittings

SAE O-ring fitting



ORFS fitting



JIC fitting (M)



TABLE 1. Hydraulic Fitting Conversion Chart

Dash Size	JIC and UNO	SAE	ORFS	NPT	BSP
04			9/16"	1/4"	1/4"
06	3/8"	3/8"	11/16"	3/8"	3/8"
08	1/2"	1/2"	13/16"	1/2"	1/2"
10		5/8"	1"		5/8"
12	3/4"	3/4"	1-3/16"	3/4"	3/4"
16			1-7/16"	1"	1"

CHAPTER

3

Hydraulic System Installation

Preparing for Installation

Important: Refer to the implement's operation manual before changing the connection or configuration of any of the existing hydraulic hoses.

For the OmniRow system to function properly, its hydraulic tank line must connect to a low pressure return connection on the tractor that prohibits the tank pressure from exceeding 200 psi. A motor return connection is the ideal connection for the OmniRow system because it prevents the pressure from being reversed to the system. The vacuum fan motor on the planter is often installed on this connection. If this is the case, it is likely that the fan return line can be connected to the SCV return port next to the fan pressure line. If there is no available return connection, one will have to be added to the tractor. Contact your local tractor service provider for more information.

FIGURE 1. Low Pressure Motor Returns



Disassemble the Planter's Drive System

Note: The OmniRow sectional system requires the use of some of the machine's hex drive shafts. Modifications to the shafts must be made to divide the planter into specific sections. Refer to the planter-specific guide included with the OmniRow installation kit to identify the planter sections.

Excluding the hex shafts, the planter's existing drive system is not required for operation once the OmniRow system is installed. Although it is not required for the entire existing ground drive or hydraulic transmission(s) to be removed from the planter, it is recommended to do so to help prevent any interference between the existing planter drive system and the OmniRow system.

FIGURE 2. Machine's Existing Hex Shaft



1. Using the planter-specific installation guide, identify the four separate planter sections that the OmniRow system will operate.

Note: Before cutting shafts, review the planter's shaft layout. Some shafts may be switched around, eliminating the need to cut some shafts.

2. Remove the drive shaft couplers or cut the 7/8" hex shaft as needed so that the planter is separated into four independent sections.
3. Determine which row units the OmniRow motors will be mounted to and remove the 7/8" hex drive shaft from those row units.

Important: Leave the existing sprocket on the left side of the row unit. The OmniRow system will utilize it and the existing drive chain to drive the seed meter.

FIGURE 3. Machine's Supplemental Support Bearings



4. Supplemental support bearings (from the right side of the planter row units, opposite the seed meter drive sprocket) can be removed as needed if they interfere with the OmniRow installation.

Important: Supplemental support bearings may be required to help support section shafts. Refer to the supplied installation guide to determine if and where support bearings need to be placed.

Note: Supplemental support bearings are generally located next to folding or flex points, or where drive chains from the transmission attach to the main hex shaft.

FIGURE 4. Components to be Removed as Needed



5. Remaining jack shafts, transmissions, and/or OEM hydraulic motors can be removed as needed if they interfere with the OmniRow installation.

Install the OmniRow Hydraulic Motors

Install the Fittings on the PWM Valve

End Row Units

FIGURE 5. Fittings and PWM Valves Installed - End Row Units

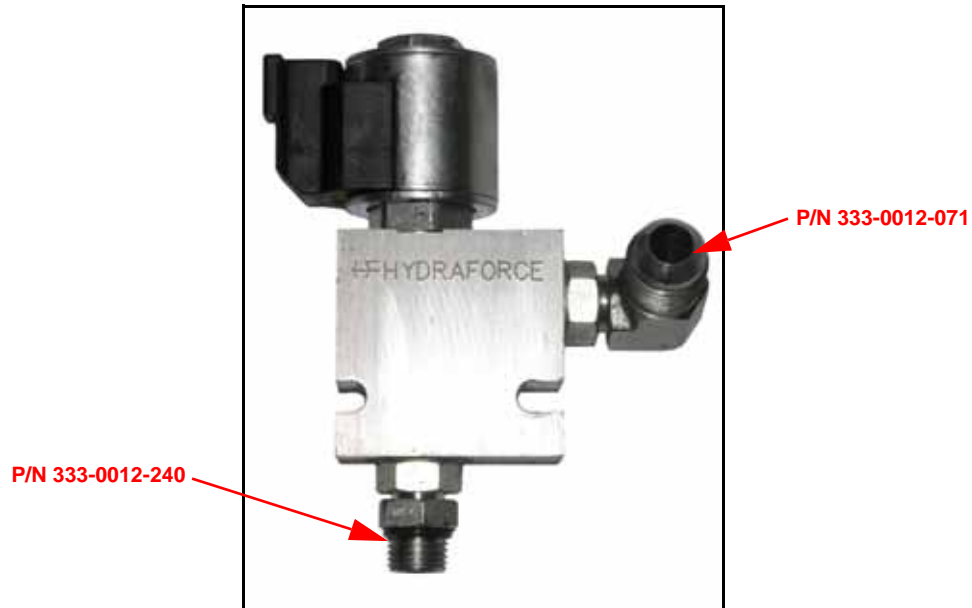

Fitting	Part Number	Port
Fitting - 9/16" SAE O-Ring (M) to 9/16" SAE O-Ring (M) Straight Adapter	333-0012-240	1
Fitting - 3/4" JIC (M) to 9/16" SAE O-Ring (M) 90° Elbow	333-0012-071	2

1. Refer to the figure and table above to install the fittings in the appropriate ports of the PWM valve (P/N 063-0131-140) for the end row units.
2. Tighten the fittings to ensure they are securely installed.

Middle Row Units

FIGURE 6. Fittings Installed PWM Valve - Middle Row Units

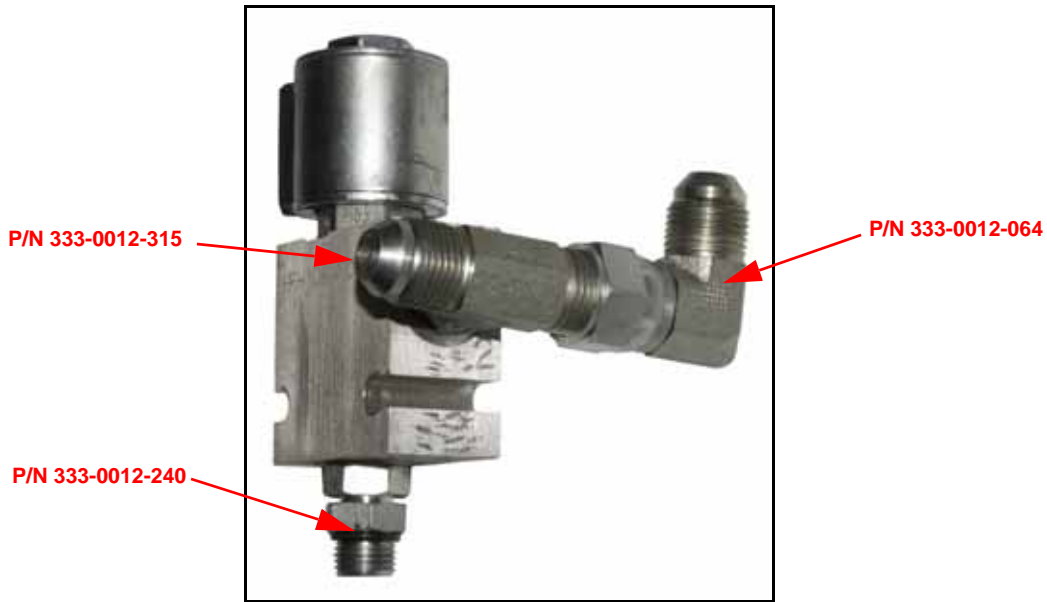

Fitting	Part Number	Port
Fitting - 9/16" SAE O-Ring (M) to 9/16" SAE O-Ring (M) Straight Adapter	333-0012-240	1
Fitting - 3/4" JIC (M) to 9/16" SAE O-Ring (M) to 3/4" JIC (M) Tee Adapter	333-0012-315	2
Fitting - 3/4" JIC M/F 90° Elbow	333-0012-064	End of Installed Tee

1. Refer to the figure and table above to install the fittings in the appropriate ports of the PWM valve (P/N 063-0131-140) for the middle row units.
2. Tighten the fittings to ensure they are securely installed.

Install the PWM Valve and Fittings on the OmniRow Hydraulic Motor

FIGURE 7. PWM Valve and Fittings Installed

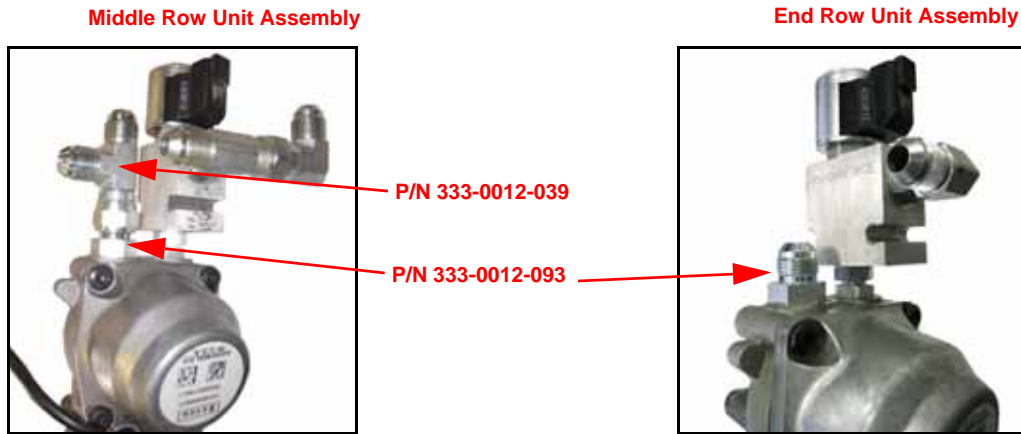

1. Install the PWM valve assembly in the pressure port of the OmniRow hydraulic motor (P/N 416-8000-001).
2. Install a 3/4" SAE O-ring (M) to 3/4" JIC (M) straight adapter fitting (P/N 333-0012-093) in the tank port of the OmniRow hydraulic motor.
3. Middle Row Units Only - Install a 3/4" JIC M/M/F swivel run tee adapter fitting (P/N 333-0012-039) on the fitting installed in the tank port of the OmniRow hydraulic motor.

Mount the OmniRow Hydraulic Motors

Important: Ensure the motor, mounting bracket, and hardware do not come into contact with the parallel linkage bars or row cleaner/coulter attachments when the row unit travels up and down.

Left Mounting

1. Replace the existing bolts used to secure the sprocket/bearing hanger with the supplied 3/8"-16 x 1-1/4" hex bolts (P/N 311-0054-106).

FIGURE 8. Mounting Bracket Installed



2. Mount the motor mounting bracket (P/N 107-0172-001) on the bolts.
3. Secure the motor mounting bracket with the supplied 3/8" zinc flanged lock nuts (P/N 312-1001-164).

FIGURE 9. Hydraulic Motor Installed



4. Mount the hydraulic motor (P/N 416-8001-001) to the motor mounting bracket using 3/8" x 2-1/2" L bolts (P/N 311-0054-111) and loosely secure with 3/8" zinc flanged lock nuts.
5. Install the 7/8" hex shafts.
6. Secure the hex shafts with existing shaft collars and/or cotter pins on the opposite side of the existing bearing or sprocket that is not next to an OmniRow hydraulic motor.
7. Secure any wires within close proximity of the installed hydraulic motor to prevent interference with the operation of the row unit.

Note: Do not secure the wires between the motor and the row unit mounting bracket, as this makes it difficult to access the wires if maintenance is required.

8. Verify the motor, shaft, and bearings are aligned.
9. Tighten the nuts to secure the installed motor and mounting bracket to the row unit.
10. Repeat the steps above to install hydraulic motors on the remaining left mounting planter row units.

Right Mounting

FIGURE 10. Mounting Bracket Installed



1. Mount the motor mounting bracket (P/N 107-0172-018) to the right side of the row unit using two 3/8"-16 x 1-1/4" L bolts (P/N 311-0054-106) and loosely secure with 3/8" zinc flanged lock nuts (P/N 312-1001-164).

FIGURE 11. Hydraulic Motor Installed



2. Mount the hydraulic motor to the motor mounting bracket using 3/8" x 2-1/2" L bolts (P/N 311-0054-111) and loosely secure with 3/8" zinc flanged lock nuts.
3. Install the 7/8" hex shafts.
4. Secure the hex shafts with existing shaft collars and/or cotter pins on the opposite side of the existing bearing or sprocket that is not next to an OmniRow hydraulic motor.

5. Secure any wires within close proximity of the installed hydraulic motor to prevent interference with the operation of the row unit.

Note: Do not secure the wires between the motor and the row unit mounting bracket, as this makes it difficult to access the wires if maintenance is required.

6. Verify the motor, shaft, and bearings are aligned.
7. Tighten the nuts to secure the installed motor and mounting bracket to the row unit.
8. Repeat the steps above to install hydraulic motors on the remaining right mounting planter row units

Install the Pressure Gauge Test Kit

The OmniRow hydraulic motors are rated up to 200 psi of back pressure. To protect the motors, reduce pressure to the PWM valves, and improve performance, pressure test ports will need to be installed in the hydraulic system to allow the hydraulic system performance to be tested.

Note: If the implement has motors controlling multiple rows, choose a section with the most row units being controlled by a single motor to perform the test.

FIGURE 12. Mounted Pressure Gauge Test Kit

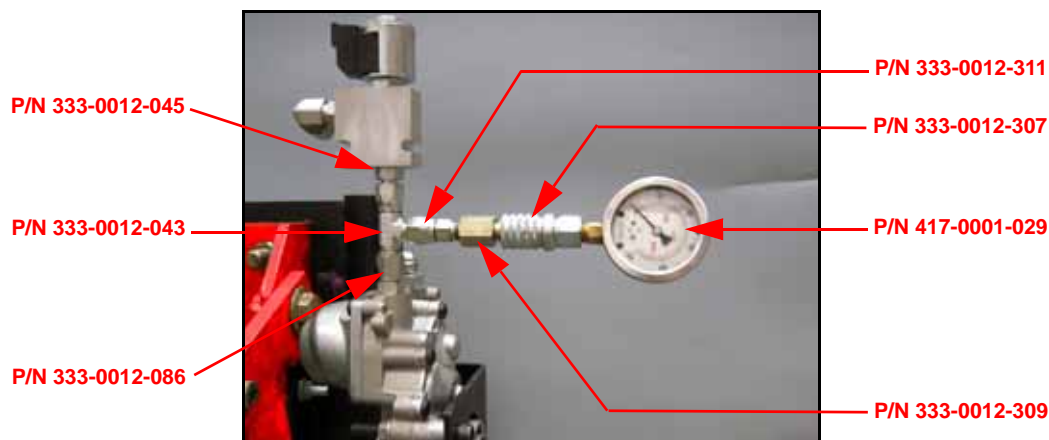

1. Install the tee fitting and gauge coupler between the PWM valve and the OmniRow hydraulic motor.
2. Disconnect the hydraulic hoses in the mounting location.
3. Install the pressure gauge test kit fittings in the appropriate location in the hydraulic system.

Install the OmniRow Hydraulic Valve

Note: Refer to the machine-specific installation guide to determine the appropriate mounting location for the OmniRow hydraulic valve. Additional hardware and mounting plate modification may be required.

Install the Fittings on the Valve

Before mounting the OmniRow hydraulic valve on the machine, install the proper fittings in the valve. This prepares the valve for installation and simplifies the hose connection process later in the procedure. Refer to the following table to install the fittings in the appropriate ports of the OmniRow valve.

FIGURE 13. Fittings Installed on the Valve



Fitting	Part Number	Port
Fitting - 7/8" JIC (M) to 7/8" SAE O-Ring (M) Straight Adapter	333-0012-246	P, T, EF
Fitting - 7/16" SAE O-Ring (M) to Male Diagnostic Nipple Hydraulic	333-0012-308	G1, G2
Fitting - 7/8" JIC (M) to 3/4" SAE O-Ring (M)	333-0012-110	CF, T1
Fitting - 3/4" SAE O-Ring (M) Plug	333-0012-211	T2
Fitting - 1/4" NPT Breather	333-0012-189	RV

Mount the OmniRow Hydraulic Valve

FIGURE 14. OmniRow Hydraulic Valve Installed

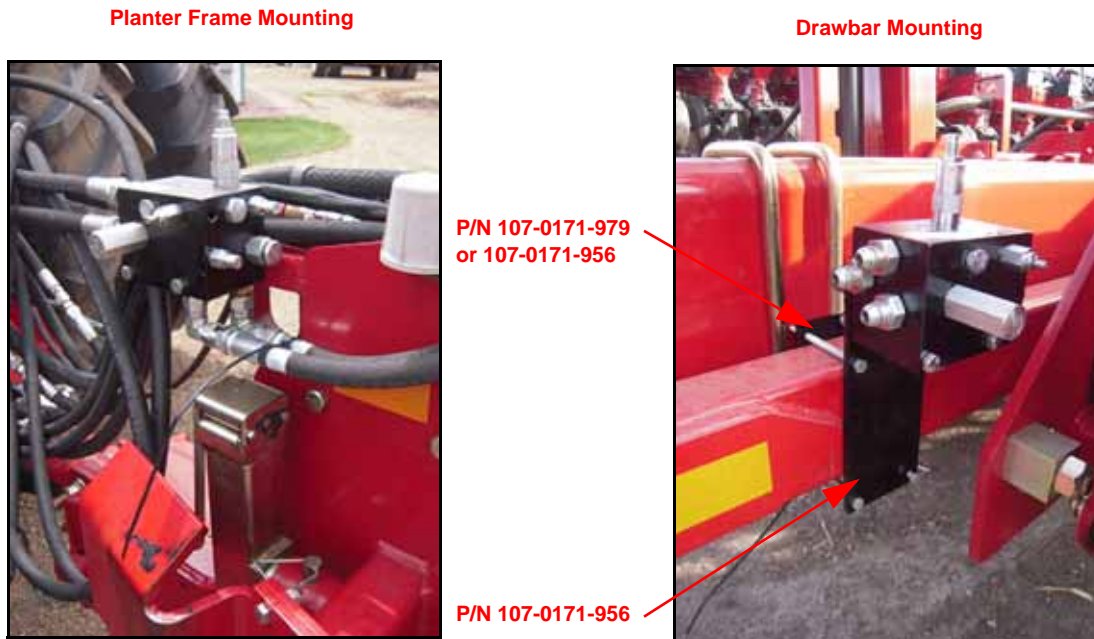

Note: The OmniRow hydraulic valve should be mounted at the front of the planter, near the hitch in a location that allows the hydraulic hoses to be connected to it without interference. Refer to the machine-specific hydraulic installation sheet for the location. Ports P, T, and EF should face the planter's hitch and Ports G1, G2, and T2 should face the planter's tool bar if possible.

Drawbar Mounting

1. Secure the OmniRow hydraulic valve to the mounting bracket (P/N 107-0171-956) using two 3/8"-16 x 4-3/4" UNC-2 machine bolts (P/N 311-0054-207) and two 3/8"-16 zinc flanged lock nuts (P/N 312-1001-164).
2. Mount the valve to the machine by "sandwiching" the planter's left diagonal draw bar between the two mounting brackets (P/N 107-0171-956 and 107-0171-979) using four 5/16"-18 x 4-3/4" bolts (P/N 311-0052-610), four 5/16"-18 flanged lock nuts (P/N 312-1001-169), and four 5/16" washers (P/N 313-2300-011).

Note: The two mounting brackets can be both P/N 107-0171-956 or one 107-0171-956 bracket and one 107-0171-979 bracket.

Planter Frame Mounting

1. Secure the OmniRow hydraulic valve to the mounting bracket (P/N 107-0171-956) using two 3/8"-16 x 4-3/4" UNC-2 machine bolts (P/N 311-0054-207) and two 3/8"-16 zinc flanged lock nuts (P/N 312-1001-164).
2. Secure the mounting bracket to the planter's frame.

Install the Planter Row Unit Pressure and Tank Hoses

Refer to the supplied machine-specific hydraulic installation sheet included with the OmniRow installation kit to install the planter row unit pressure and tank hoses.

Important: Pay close attention to the hydraulic hose part numbers on the diagram and the locations in which each must be installed. Install all pressure hoses before installing tank hoses.

Note: As illustrated in the installation sheet, there are tee fittings installed to connect the pressure and tank hoses to the open center pressure-reducing valve. Additional 45° and 90° elbow fittings are also supplied to assist in routing the hydraulic hoses around obstacles. Install these additional fittings as needed.

Some of the supplied hoses contain both straight and 90° ends. When installing the hoses, the 90° ends of the hoses should be installed on the ends of the fittings that point up. The straight ends of the hoses are installed on the 90° elbow fittings installed on the end row units. Refer to Figure 15 on page 17.

FIGURE 15. Hose Installation Illustration

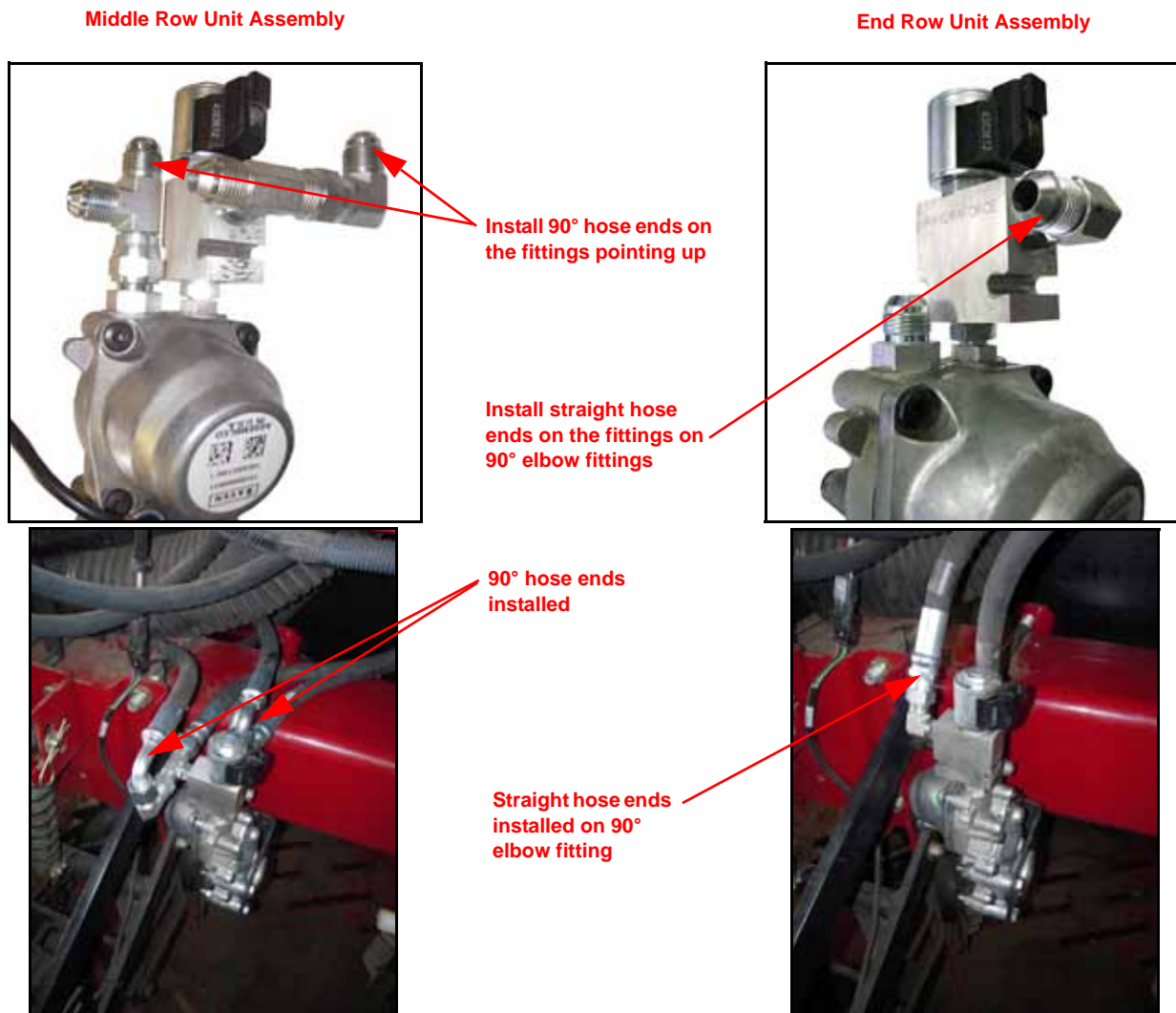
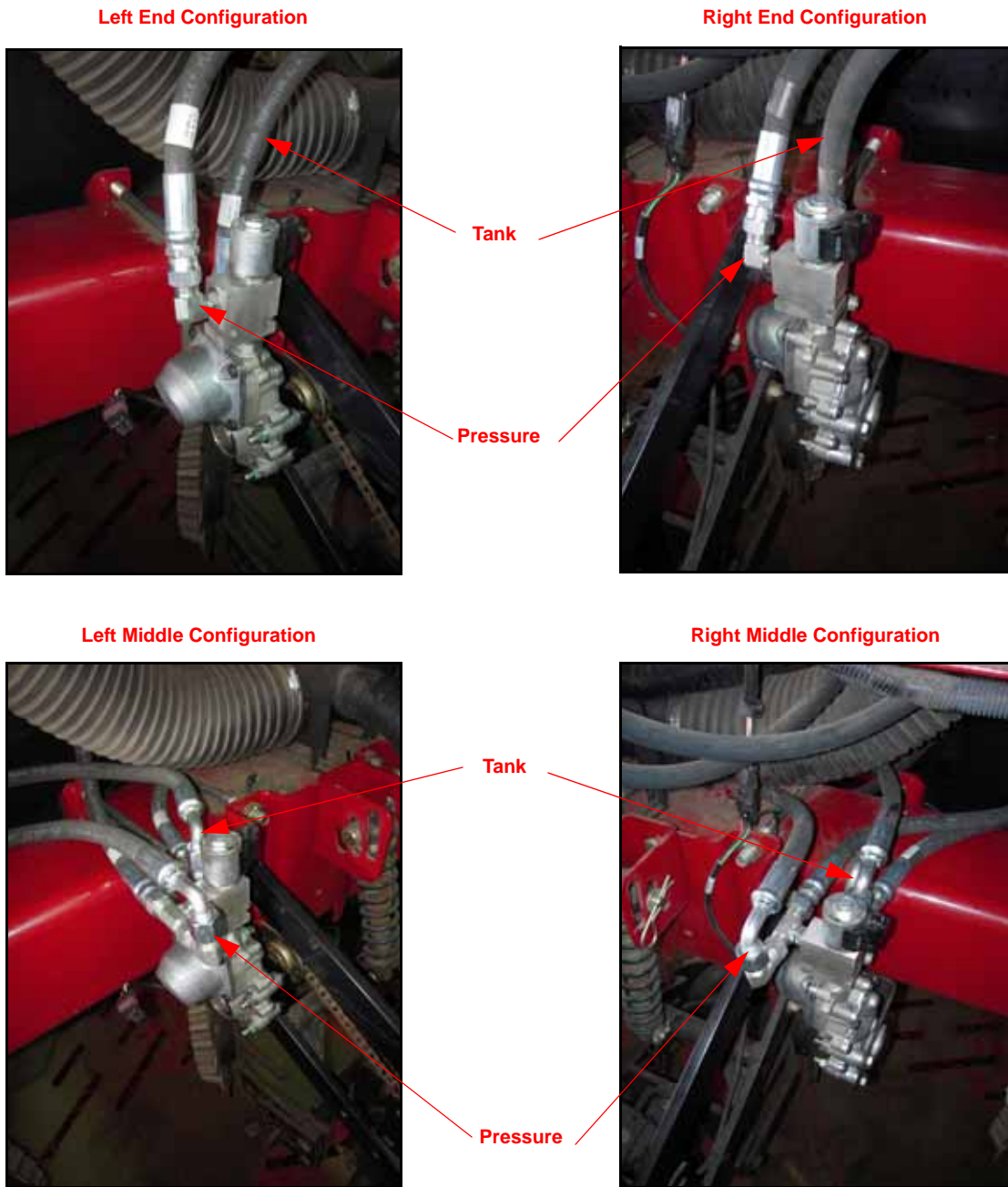

FIGURE 16. Pressure and Tank Hoses Installed



1. Install the supplied hydraulic hoses on each end of the installed tee fittings in Port 2 of the PWM valves, continuing from one section to the next, until all pressure hoses are installed.
2. Install the supplied hydraulic hoses on each end of the tank tee fittings, continuing from one section to the next, until all tank hoses are installed.

Install the OmniRow Valve Pressure and Tank Hoses

FIGURE 17. OmniRow Valve Pressure and Tank Hoses Installed



Refer to the supplied machine-specific hydraulic installation sheet included with the OmniRow installation kit to install the OmniRow hydraulic valve pressure and tank hoses.

Important: Pay close attention to the hydraulic hose part numbers on the diagram and the locations in which each must be installed.

Note: Install the supplied 90° elbow fittings (P/N 333-0012-108) on the OmniRow hydraulic valve as needed when installing the hydraulic hoses.

FIGURE 18. Hoses Clamped



Note: Use the provided hose clamps (P/N 434-2000-001) to secure the installed hydraulic lines to each end of the machine's draw bar as illustrated in the figure above.

1. Install the supplied hydraulic hose labeled P on the fitting installed in Port P of the OmniRow valve.
2. Install the supplied hydraulic hose labeled T on the fitting installed in Port T of the OmniRow valve.

3. Install the supplied hydraulic hose labeled EF on the fitting installed in Port EF of the OmniRow valve.

Note: *If the hydraulic system will be configured as a closed center system, do not install the EF hose in Port EF of the OmniRow valve. Instead, install the supplied plug in that port.*

4. Install 7/8" SAE O-ring (M) to Pioneer (M) hydraulic couplers (P/N 333-0012-310) on the remaining ends of the installed hydraulic hoses.
5. Route the ends of the installed hydraulic hoses to the planter's hitch.
6. Install the indicated hydraulic hose on the installed fitting in Port CF of the OmniRow valve.
7. Route the installed hydraulic hose along the machine's draw bar and connect to the tee fitting installed in line with the **pressure** hoses between the row units as indicated on the machine-specific hydraulic installation sheet.
8. Install the indicated hydraulic hose on the installed fitting in Port T1 of the OmniRow valve.
9. Route the installed hydraulic hose along the machine's draw bar and connect it to tee fitting installed in line with the **tank** hoses between the row units as indicated on the machine-specific hydraulic installation sheet.

Connect the Hydraulic Hoses to the Tractor

The OmniRow system may be operated as either an open center or closed center hydraulic system. The installer should decide which is the desired method, but most systems should operate as a closed center system. Consider the following factors when determining the hydraulic system configuration:

- Machines containing fans that are controlled by a valve on the planter should have a closed center hydraulic system.
- Planters containing an auxiliary hydraulically-operated liquid pump or fans controlled by the tractor remote may need an open center hydraulic system to prevent overheating issues.

Open Center Hydraulic System

FIGURE 19. Hydraulic Hoses Connected to the Tractor

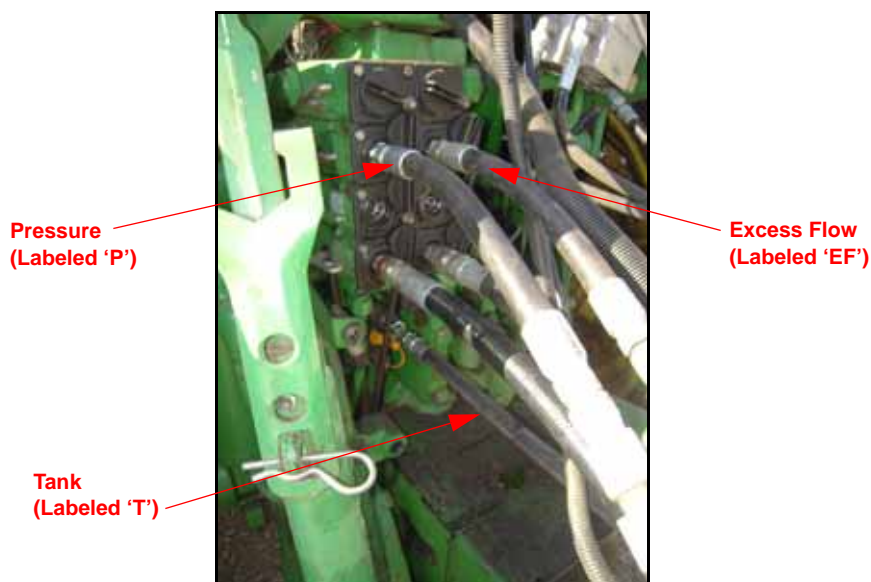

1. Connect the pressure hose (labeled 'P') to the pressure side of the tractor's SCV.
2. Connect the excess flow hose (labeled 'EF') to the return side of the tractor's SCV.
3. Connect the tank hose (labeled 'T') to the low pressure motor return on the tractor.

Closed Center Hydraulic System

FIGURE 20. Hydraulic Hoses Connected to the Tractor

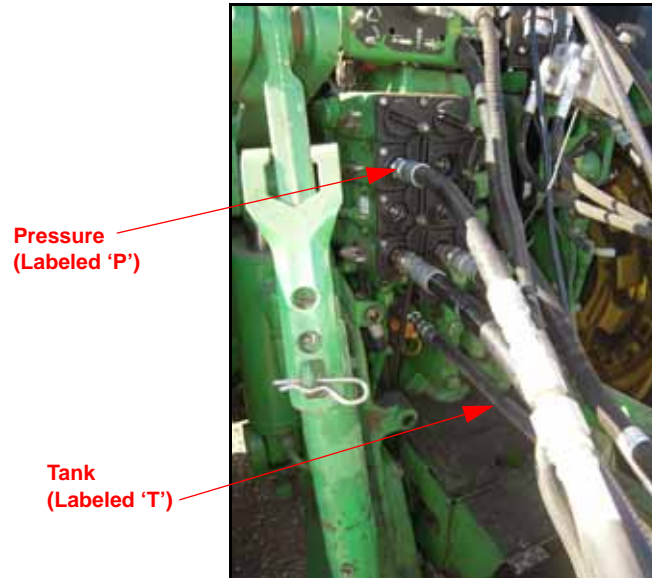

1. Connect the pressure hose (labeled 'P') to the pressure side of the tractor's SCV.
2. Connect the tank hose (labeled 'T') to the low pressure motor return on the tractor.

Install the Tractor Cables

The tractor cables are specific to the tractor being used to pull the planter. For available kits and ordering information, contact your local Raven dealer.

1. Install the chassis cable's main battery connections, leaving room to provide access to the fuses in the cable.
2. Route the chassis cable to the back of the tractor.
3. Connect the chassis cable to the Envizio Pro II/Viper Pro chassis interface cable (P/N 115-0172-001).

FIGURE 1. Extension Cable Connected to the Tractor Harness Cable



4. Route the cab cable into the cab and connect it to the Envizio Pro II.
5. Install the supplied CAN terminator (P/N 063-0172-369B) to the CAN connection on the Envizio Pro II/Viper Pro chassis interface cable (P/N 115-0172-001).

Install the Seed Tube Sensors

The OmniRow system can not connect to the factory-installed mux/bus-style seed tube sensors. Replacement seed tube sensors (P/N 422-0000-107) must be installed to function with the OmniRow system. Contact your local Raven dealer to order replacement seed tube sensors.

1. Disconnect and remove the factory-installed seed tube sensors.
2. Using the supplied cable ties, install the replacement seed tube sensor on the seed tube.
3. Verify sensor is firmly seated and secured on the seed tube.

Install the OmniRow Harness Cables

FIGURE 2. Seed Tube Sensor Connection



1. Locate the machine's seed tube sense cable.

Note: *The seed tube sense cable is usually located in the center of the planter.*

Note: *The OmniRow system cannot be connected to the Case mux/bus-style seed sensor monitoring system harness and does not recognize Case mux/bus-style seed tube sensors. Contact your local Raven OmniRow dealer to order replacement seed tube sensors and monitoring harness cables.*

2. Connect the Seed Tube Sensors connector on the OmniRow harness cable (P/N 115-3001-065) to the machine's seed tube sense cable.
3. Route the 6-pin weatherpack connector section breakouts of the OmniRow harness to the corresponding section's hydraulic motor.

Note: *The harness cable should be laid on top of the installed hydraulic hoses. Tie-off any excess cable, allowing enough slack in the cable around the machine's pivot points for machine movement.*

FIGURE 3. Harness Cable and Adapter Cable Connection



4. Connect the 6-pin weatherpack connectors of the four OmniRow sectional control adapter cables (P/N 115-3001-050) to the 6-pin weatherpack connectors of the OmniRow harness cable.

FIGURE 4. Harness Cable Connections on the Row Units



5. Connect the 2-pin Deutsch connector of the adapter cable to the PWM valve installed on section 1 of the planter.
6. Connect the 3-pin metripack connector of the adapter cable to the OmniRow hydraulic motor installed on section 1 of the planter.
7. Repeat steps 5 - 6 above to connect the adapter cables to the remaining planter sections.
8. Connect the CAN/Power extension cable to the To CAN/Pwr/Speed Extension Cable connector of the OmniRow harness cable.
9. Route the extension cable along the planter's draw bar (along with the installed pressure and tank hoses).
10. Connect the extension cable to the installed tractor harness cable.
11. Secure the installed cables with cable ties.

Install the Proximity Switch

FIGURE 5. Proximity Switch Installed

Switch Mounting for 1200/1240 Series



Switch Mounted on Tractor for 1230 Series



Switch Mounting for 1250 Series



1. Refer to the supplied Remote Implement Proximity Switch Installation Sheet (P/N 016-0171-374) to install the proximity switch with the parts provided.

Note: *The proximity switch brackets can be assembled in multiple configurations to fit various models of planters. Not all of the supplied brackets may be required for installation.*

2. Route and connect the implement switch connector of the OmniRow harness cable (P/N 115-3001-065) to the installed proximity switch.

Install the OmniRow Node

FIGURE 6. OmniRow Node Installed



Note: The node mounting plate has several options for mounting the magnets. Determine the best node mounting position(s) appropriate for the machine's configuration.

1. Install three 1/4"-20 x 3/4" HD hex bolts (P/N 311-0049-103) in the desired holes of the node mounting plate using three 1/4"-20 UNC nylon insert lock nuts (P/N 312-4000-057).
2. Mount the OmniRow node (P/N 063-3001-001) to the node mounting plate (P/N 107-0171-897) using three 3/8"-16 x 1" HD hex bolts (P/N 311-0054-105) and three 3/8"-16 nylon insert lock nuts (P/N 312-4000-061).
3. Mount the magnets (P/N 418-0000-013) to the previously installed 1/4"-20 x 3/4" HD hex bolts using three 1/4"-20 flanged lock nuts (P/N 312-1001-168).

Note: Position the node so that the cable connections face down or to the side.

4. Insert the large, rectangular node connectors on the harness cable into the correct ports of the OmniRow node.
5. Tighten the bolts on the node connectors to secure the connections.

Important: Do not over-tighten the node connections. Over-tightening can cause poor connections, resulting in substandard system performance.

System Installation Verification

1. Cycle the planter's folding operations to ensure that:
 - Hoses are not rubbing on or interfering with moving parts.
 - Hydraulic fluid is not leaking from the system.
2. Cycle the planter up and down functions to verify there is no interference with the installed OmniRow system.
3. If the planter is equipped with row cleaners/coulters, verify travel or row cleaners/coulters do not interfere with OmniRow equipment and make necessary routing changes to prevent contact.

Note: If there are issues with the OmniRow system, turn off the machine and correct them immediately. For additional assistance, contact your local Raven dealer.

E**Electrical Safety** 2**H****Hydraulic Fittings** 4**Hydraulic Safety** 2**Hydraulic System** 5

- Connecting Hydraulic Hoses to the Tractor 20
 - Closed Center Hydraulic System 21
 - Open Center Hydraulic System 20
- Disassembling the Planter's Drive System 6
- Installing Planter Row Unit Pressure and Tank Hoses 17
- Installing the OmniRow Hydraulic Motors 9
 - Installing Fittings on the PWM Valve 9
 - Installing PWM Valve and Fittings on Hydraulic Motor 11
 - Mounting the Hydraulic Motors 11
- Installing the OmniRow Hydraulic Valve 14
 - Installing Fittings on the Valve 15
 - Mounting the OmniRow Hydraulic Valve 16
- Installing the OmniRow Hydraulic Valve Pressure and Tank Hoses 19
- Installing the Pressure and Tank Hoses 17
- Installing the Pressure Gauge Test Kit 14
- Preparing for Installation 5

I**Important Safety Information**

- Electrical Safety 2
- Hydraulic Safety 2

P**Point of Reference** 4**Preparing for Installation** 3**R****Recommendations** 3**S****System Installation Verification** 27**T****Tools Needed** 4**W****Wiring** 23

- Installing the OmniRow Harness Cables 24
- Installing the OmniRow Node 27
- Installing the Proximity Switch 26
- Installing the Tractor Cables 23

RAVEN

RAVEN INDUSTRIES

Limited Warranty

What Does this Warranty Cover?

This warranty covers all defects in workmanship or materials in your Raven Applied Technology Division product under normal use, maintenance, and service.

How Long is the Coverage Period?

Raven Applied Technology Division products are covered by this warranty for 12 months after the date of purchase. This warranty coverage applies only to the original owner and is nontransferable.

How Can I Get Service?

Bring the defective part and proof of purchase to your Raven dealer. If your dealer agrees with the warranty claim, the dealer will send the part and proof of purchase to their distributor or to Raven Industries for final approval.

What Will Raven Industries Do?

Upon confirmation of the warranty claim, Raven Industries will, at our discretion, repair or replace the defective part and pay for return freight.

What is not Covered by this Warranty?

Raven Industries will not assume any expense or liability for repairs made outside our facilities without written consent. Raven Industries is not responsible for damage to any associated equipment or products and will not be liable for loss of profit or other special damages. The obligation of this warranty is in lieu of all other warranties, expressed or implied, and no person or organization is authorized to assume any liability for Raven Industries.

Damages caused by normal wear and tear, misuse, abuse, neglect, accident, or improper installation and maintenance are not covered by this warranty.

RAVEN

Case IH Sectional
OmniRow™ Installation Manual
(P/N 016-3001-011 Rev A 01/12 E18777)



Raven Industries

Applied Technology Division
P.O. Box 5107
Sioux Falls, SD 57117-5107
www.ravenprecision.com

Toll Free (U.S. and Canada): (800)-243-5435
or Outside the U.S. :1 605-575-0722
Fax: 605-331-0426
www.ravenhelp.com

Notice: This document and the information provided are the property of Raven Industries, Inc. and may only be used as authorized by Raven Industries, Inc. All rights reserved under copyright laws.