

RBR Enterprise Vector 300 LS/Venturi LS RS1/HDU Installation Manual

016-5035-002 Rev. B

2/20

E34704



DISCLAIMER

While every effort has been made to ensure the accuracy of this document, Raven Industries assumes no responsibility for omissions and errors. Nor is any liability assumed for damages resulting from the use of information contained herein.

Raven Industries shall not be responsible or liable for incidental or consequential damages or a loss of anticipated benefits or profits, work stoppage or loss, or impairment of data arising out of the use, or inability to use, this system or any of its components. Raven Industries shall not be held responsible for any modifications or repairs made outside our facilities, nor damages resulting from inadequate maintenance of this system.

As with all wireless and satellite signals, several factors may affect the availability and accuracy of wireless and satellite navigation and correction services (e.g. GPS, GNSS, SBAS, etc.). Therefore, Raven Industries cannot guarantee the accuracy, integrity, continuity, or availability of these services and cannot guarantee the ability to use Raven systems, or products used as components of systems, which rely upon the reception of these signals or availability of these services. Raven Industries accepts no responsibility for the use of any of these signals or services for other than the stated purpose.

Chapter 1	Important Safety Information.....	1
	Instructions for Wire Routing	2
Chapter 2	Introduction.....	5
	Preparing for Installation	5
	Recommendations	6
	Point of Reference	6
	Kit Contents	7
	SmarTrax to RS1 Retrofit Kits	7
	RS1/HDU Kits	7
	Updates	7
Chapter 3	SmarTrax Removal.....	9
	SmarTrax Component Removal	9
	System Diagram	10
	SmarTrax to RS1 Retrofit Kit Installation Instructions	11
Chapter 4	Hydraulic System Installation.....	13
	Install Fittings in the Steering Valve	14
	Mount the Steering Valve	15
	Install the Left and Right Steering Hoses	16
	Install the Pressure and Tank Hoses	19
	Install the Load Sense Hoses	21
	Hydraulic Diagram	23
Chapter 5	Wheel Angle Sensor Installation	25
	Assemble the WAS	25
	Install the WAS	25
Chapter 6	Cab Component Installation.....	29
	RS1 Installation	29
	Cab Component Installation	31
	Install the Master Switch	33
	Install System Cables	34
	HDU Cable	34
	HDU Switch Cable	36
	Valve Cable	37
	RS1 Cable	40
	Routine Operation	42
	System Diagrams	43
Appendix A	Kits Lists.....	45
	Kits	45

CHAPTER

1

IMPORTANT SAFETY INFORMATION

NOTICE

Read this manual and the operation and safety instructions included with your implement and/or controller carefully before installing the RS1/HDU™ system.

- Follow all safety information presented within this manual.
- If you require assistance with any portion of the installation or service of your Raven equipment, contact your local Raven dealer for support.
- Follow all safety labels affixed to the RS1/HDU system components. Be sure to keep safety labels in good condition and replace any missing or damaged labels. To obtain replacements for missing or damaged safety labels, contact your local Raven dealer.

When operating the machine after installing RS1/HDU, observe the following safety measures:

- Be alert and aware of surroundings.
- Do not operate RS1/HDU or any agricultural equipment while under the influence of alcohol or an illegal substance.
- Remain in the operator's position in the machine at all times when RS1/HDU is engaged.
- Disable RS1/HDU when exiting the operator's seat and machine.
- Do not drive the machine with RS1/HDU enabled on any public road.
- Determine and remain a safe working distance from other individuals. The operator is responsible for disabling RS1/HDU when the safe working distance has diminished.
- Ensure RS1/HDU is disabled prior to starting any maintenance work on RS1/HDU or the machine.

WARNING

- When starting the machine for the first time after installing RS1/HDU, be sure that all persons stand clear in case a hose has not been properly tightened.
- The machine must remain stationary and switched off during RS1/HDU installation or maintenance.

INSTRUCTIONS FOR WIRE ROUTING

The word “harness” is used to mean all electrical leads and cables, bundled and unbundled. When installing harness, secure it at least every 30 cm (12in) to the frame. Follow existing harness as much as possible and use these guidelines:

Harness should not contact or be attached to:

- Lines and hoses with high vibration forces or pressure spikes
- Lines and hoses carrying hot fluids beyond harness component specifications

Avoid contact with any sharp edge or abrading surfaces such as, but not limited to:

- Sheared or flame cut edges
- Edges of machined surfaces
- Fastener threads or cap screw heads
- Ends of adjustable hose clamps
- Wire exiting conduit without protection, either ends or side of conduit
- Hose and tube fittings

Routing should not allow harnesses to:

- Hang below the unit
- Have the potential to become damaged due to exposure to the exterior environment. (i.e. tree limbs, debris, attachments)
- Be placed in areas of or in contact with machine components which develop temperatures higher than the temperature rating of harness components
- Wiring should be protected or shielded if it needs to route near hot temperatures beyond harness component specifications

Harnessing should not have sharp bends

Allow sufficient clearance from machine component operational zones such as:

- Drive shafts, universal joints and hitches (i.e. 3-point hitch)
- Pulleys, gears, sprockets
- Deflection and backlash of belts and chains
- Adjustment zones of adjustable brackets
- Changes of position in steering and suspension systems
- Moving linkages, cylinders, articulation joints, attachments
- Ground engaging components

For harness sections that move during machine operation:

- Allow sufficient length for free movement without interference to prevent: pulling, pinching, catching or rubbing, especially in articulation and pivot points
- Clamp harnesses securely to force controlled movement to occur in the desired harness section
- Avoid sharp twisting or flexing of harnesses in short distances
- Connectors and splices should not be located in harness sections that move

Protect harnesses from:

- Foreign objects such as rocks that may fall or be thrown by the unit
- Buildup of dirt, mud, snow, ice, submersion in water and oil
- Tree limbs, brush and debris
- Damage where service personnel or operators might step or use as a grab bar
- Damage when passing through metal structures

IMPORTANT: Avoid directly spraying electrical components and connections with high pressure water. High pressure water sprays can penetrate seals and cause electrical components to corrode or otherwise become damaged. When performing maintenance:

- Inspect all electrical components and connections for damage or corrosion. Repair or replace components, connections, or cable as necessary.
- Ensure connections are clean, dry, and not damaged. Repair or replace components, connections, or cable as necessary.
- Clean components or connections using low pressure water, pressurized air, or an aerosol electrical component cleaning agent.
- Remove visible surface water from components, connections, or seals using pressurized air or an aerosol electrical component cleaning agent. allow components to dry completely before reconnecting cables.

CHAPTER

INTRODUCTION

2

Congratulations on your purchase of the RS1/HDU system! This system is designed to provide cutting-edge, hands-free steering of the machine via Global Positioning System (GPS) coordinates.

NOTE: If you have purchased kit P/N 115-5035-002, refer to Chapter 4, *Hydraulic System Installation*, to begin the installation process.

If you have purchased kit P/N 115-5035-058, refer to Chapter 3, *SmArTrax Removal*, to begin the installation process.

This manual applies to the following machines:

MAKE: RBR

MODEL: Vector 300 LS/Venturi LS

FIGURE 1. RBR Vector 300 LS



PREPARING FOR INSTALLATION

Before installing the RS1/HDU system, park the machine where the ground is level, clean, and dry. Turn off the machine and leave it turned off for the duration of the installation process. Bleed pressure from the hydraulic system by loosening the hydraulic fittings slowly, where applicable.

During the installation process, follow good safety practices. Be sure to carefully read the instructions in this manual as you complete the installation process.

RECOMMENDATIONS

Raven Industries recommends the following best practices when installing or operating the RS1/HDU system for the first time, at the start of the season, or when moving the RS1/HDU system to another machine:

- Install the GPS antenna in the recommended location. Refer to the following table for the machine-specific antenna mounting location.
- Ensure the machine's hydraulic filters have been recently changed and there are no issues with the machine's hydraulic system (e.g., pump issues, faulty hydraulic motors, fine metal deposits in the hydraulic hoses, etc.).
- Ensure the machine's hydraulic system is using fresh oil and debris is flushed from the hydraulic hoses, valves, and filters.

Raven Industries recommends the following best practices when installing the RS1/HDU system:

- Use part numbers to identify the parts.
- Do not remove the plastic wrap from a part until it is necessary for installation.
- Do not remove plastic caps from a part until it is necessary for installation.

POINT OF REFERENCE

The instructions in this manual assume that you are standing behind the machine, looking toward the cab.

KIT CONTENTS

This section contains a list of kits that may be included with the components. Before beginning the RS1 installation, compare the items in the kit with the components specific to your installation on the list(s) in “Kits Lists” on page 45. If you have questions about the kit, contact your Raven dealer.

SmarTrax to RS1 Retrofit Kits

Description	Kit Number
Kit, WAS, RBR	117-0192-053
Kit, HDU w/o Hydraulics, STX to RS1 Retrofit, RBR Vector, MY 2016-18	117-5035-058

RS1/HDU Kits

Description	Kit Number
Kit, WAS, RBR	117-0192-053
Kit, Hydraulic, PVG Dynamic Load Sense	117-0199-126
Kit, HDU, w/ Hydraulics, RBR Vector, MY 2016-18	117-5035-002

UPDATES

Software and manual updates are available on the Raven Applied Technology website:

<http://www.ravenhelp.com>

At Raven Industries, we strive to make your experience with our products as rewarding as possible. One way to improve this experience is to provide us with feedback on this manual.

Your feedback will help shape the future of our product documentation and the overall service we provide. We appreciate the opportunity to see ourselves as our customers see us and are eager to gather ideas on how we have been helping or how we can do better.

To serve you best, please send an email with the following information to

techwriting@ravenind.com

- RBR Enterprise Vector 300 LS/Venturi LS RS1/HDU Installation Manual
- 016-5035-002 Rev. B
- Any comments or feedback (include chapter or page numbers if applicable).
- Let us know how long have you been using this or other Raven products.

We will not share your email or any information you provide with anyone else. Your feedback is valued and extremely important to us.

Thank you for your time.



SMARTRAX COMPONENT REMOVAL

NOTE: Prior to removal of the SmarTrax components, verify the machines cab is equipped with cab cabling:

- 115-0172-243 - Cable, Cab, MY2016, RBR.
- 115-0172-242 - Cable, Cab, Console, Viper 4, RBR, MY2016

1. Locate the SmarTrax steering node (P/N 063-0173-228) on the right-hand side of the cab floor, underneath the armrest.
2. Remove the hardware that secures it to the floor.

NOTE: Save the hardware that was removed as they will be reused in the installation of the STX to RS1 Retrofit Kit (P/N 117-5035-058)

3. Locate the SmarTrax node cable (P/N 115-4001-173) that is connected to the SmarTrax steering node (P/N 063-0173-228).
4. Follow it back to where it connects to the cab cables (P/N 115-0172-243) 8-pin connector, labeled "SmarTrax," and disconnect.
5. Install the provided 8-pin dust cap onto the cab cables (P/N 115-0172-243) connector, labeled "SmarTrax," once the SmarTrax node cable (P/N 115-4001-173) is removed.
6. Disconnect any GPS connections from the SmarTrax node cable (P/N 115-4001-173) and remove.

NOTE: The existing GPS source will be replaced with RS1.

7. Disconnect the 2-pin enable connection from the SmarTrax node cable (P/N 115-4001-173).

NOTE: If the SmarTrax steering system used the enable switch on the machines joystick previously, the 2-pin enable connector from the machines cabling will get reused when installing the new SmarTrax to RS1 Retrofit Kit (P/N 117-5035-058).

If the SmarTrax steering system used a Raven foot switch (P/N 063-0172-470) previously, the old foot switch will be reused when installing the new SmarTrax to RS1 Retrofit Kit (P/N 117-5035-058)

8. Disconnect the 6-pin valve cable (P/N 115-4001-174) connection from the SmarTrax node cable (P/N 115-4001-173).
9. Route the valve cable (P/N 115-4001-174) out of the cab and trace it forward to where it connects to the SmarTrax steering valve (P/N 334-003-088).

NOTE: The SmarTrax steering valve (P/N 334-0003-088) is located on the front, left-hand side of the machine, underneath the catwalk.

10. Disconnect the 3-pin pressure transducer connection on the valve cable (P/N 115-4001-174) from the SmarTrax steering valve (P/N 334-003-088).

Disconnect the 4-pin valve connection on the valve cable (P/N 115-4001-174) from the SmarTrax steering valve (P/N 334-0003-088).

SYSTEM DIAGRAM

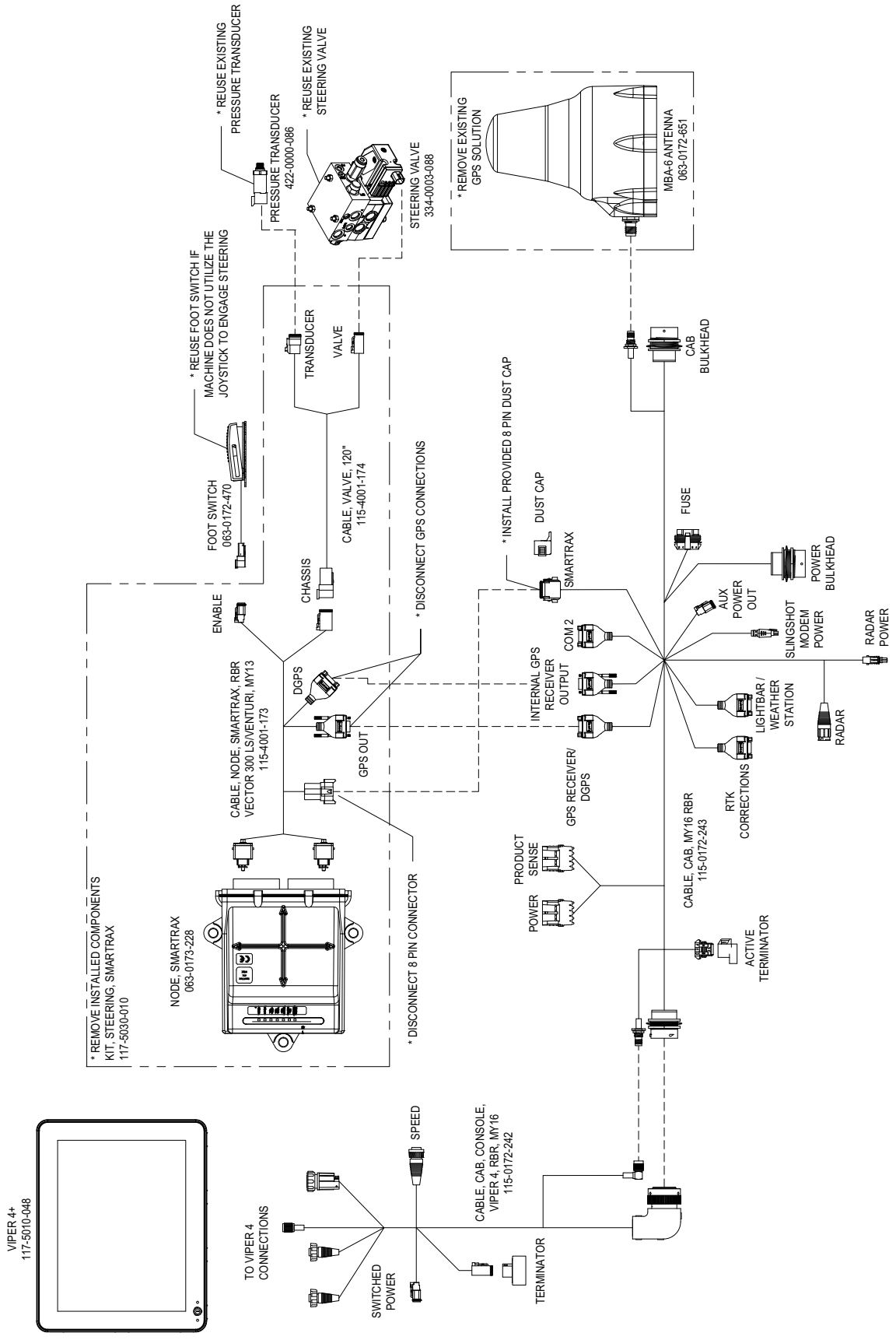

SMARTRAX TO RS1 RETROFIT KIT INSTALLATION INSTRUCTIONS

Refer to Chapter 5, *Wheel Angle Sensor Installation*, and Chapter 6, *Cab Component Installation*, for details on how to install the new components provided in the SmarTrax to RS1 Retrofit Kit (P/N 117-5035-058).



 **WARNING**

Hydraulics are under pressure. Care should always be taken with a system that has been pressurized.

Before beginning the RS1/HDU hydraulic installation, turn off the machine and relieve pressure by turning the steering wheel left and right.

Never work on a hot machine. Always allow it to cool before performing diagnostics, maintenance, or routine service.

When disconnecting or purging hydraulic hoses, be aware that the hydraulic fluid within the machine's system may be extremely hot and under high pressure.

Tampering with hydraulic valves may cause serious injury or death, and will void the warranty.



 **CAUTION**

When installing hydraulic components, performing diagnostics, maintenance, or routine service, ensure precautions are taken to prevent any foreign material from being introduced into the machine's hydraulic system.

Objects or materials that are able to bypass the machine's hydraulic filtration system will reduce performance and possibly damage the steering hydraulic valve.



NOTICE

The appearance of the RS1/HDU hydraulic valve may vary slightly from the images contained in this manual. However, the fittings, hose connections, and cable connections remain the same.

INSTALL FITTINGS IN THE STEERING VALVE

Before mounting the RS1/HDU valve (P/N 334-0003-088) on the machine, install the proper fittings in the valve. This prepares the valve for installation and simplifies the hose connection process later in the procedure.

FIGURE 1. Fittings Installed in the Steering Valve

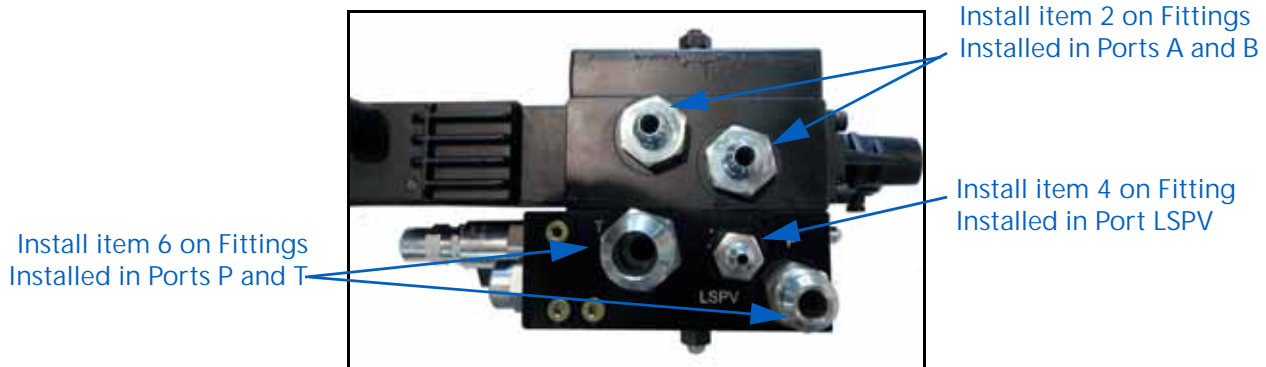

Item	Description	Part Number	Port
1.	Fitting - -6 JIC (M) to -10 SAE O-Ring (M) Straight Adapter	333-0012-106	A, B
2.	Fitting - -6 JIC M/F 90° Swivel Elbow	333-0012-042	A, B
3.	Fitting - -4 JIC (M) to -6 SAE O-Ring (M) Straight Adapter	333-0012-044	LSPV, LS STEER
4.	Fitting - -4 JIC M/F 90° Swivel Elbow	333-0012-154	LSPV
5.	Fitting - -10 JIC (M) to -8 SAE O-Ring (M) Straight Adapter	333-0012-110	P, T
6.	Fitting - -10 JIC M/F 90° Swivel Elbow	333-0012-108	P, T
7.	Transducer - 0-3000 PSI Pressure	422-0000-086	PS

MOUNT THE STEERING VALVE

FIGURE 2. Steering Valve Mounting Location



1. Identify the steering valve (P/N 334-0003-088) mounting location on the inside of the machine's frame, below the walkway.

FIGURE 3. Steering Valve Installed



2. Secure the steering valve to the valve mounting bracket using four 5/16"-18 x 7/8" hex bolts (P/N 311-0052-104) and four 5/16" lock washers (P/N 313-1000-019).
3. Remove the top bolt from the machine's catwalk.
4. Align the lip of the valve mounting bracket with the hole in the catwalk and the adjacent hole in the machine's frame.
5. Install the valve mounting bracket on the machine using the machine's bolt that was removed in step 2 and one 3/8"-16 UNC x 1-4" bolt (P/N 311-0054-106, one 3/8" flat washer (P/N 313-2300-013), and one 3/8"-16 UNC 3B nylon insert lock washer (P/N 312-4000-061).

INSTALL THE LEFT AND RIGHT STEERING HOSES

FIGURE 4. Steering Orbital Location



1. Locate the machine's steering orbital under the hood, just in front of the cab.

FIGURE 5. Left Steering Port on Steering Orbital

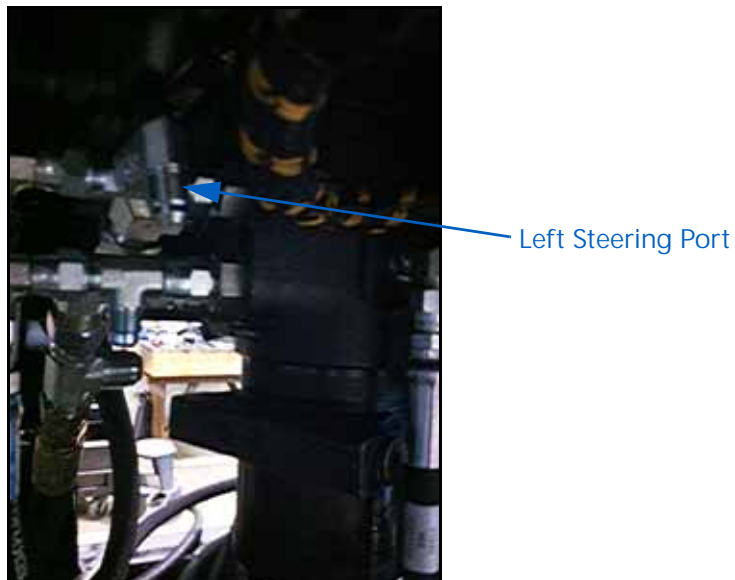

2. Remove the cap from the tee fitting installed in the left steering port (upper-right corner) of the steering orbital.

FIGURE 6. Left Steering Hose Installed on Steering Orbital



3. Install the straight end of the supplied hydraulic hose (P/N 214-1000-780) on the open port of the tee fitting.

FIGURE 7. Left Steering Hose Installed on Steering Valve



4. Connect the 90° end of the installed hydraulic hose to the fitting installed in Port A of the steering valve (P/N 334-0003-088).

FIGURE 8. Right Steering Port on Steering Orbital

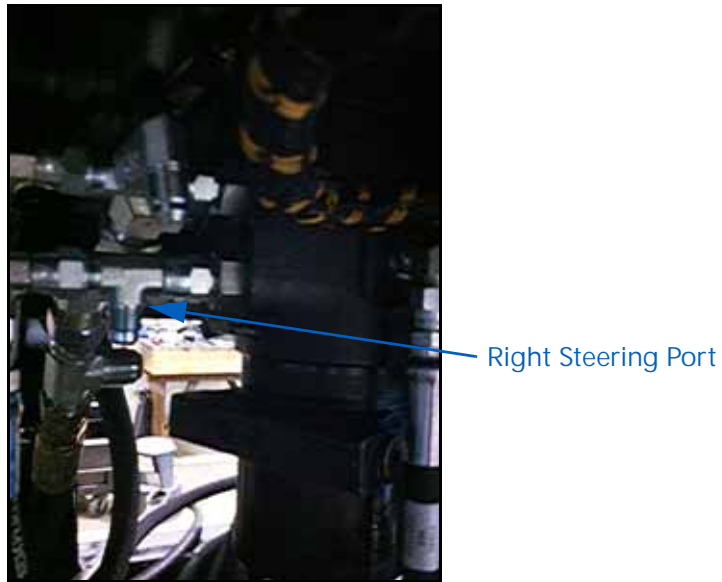

5. Remove the cap from the tee fitting installed in the right steering port (lower-right corner) of the steering orbital.

FIGURE 9. Right Steering Hose Installed on Steering Orbital

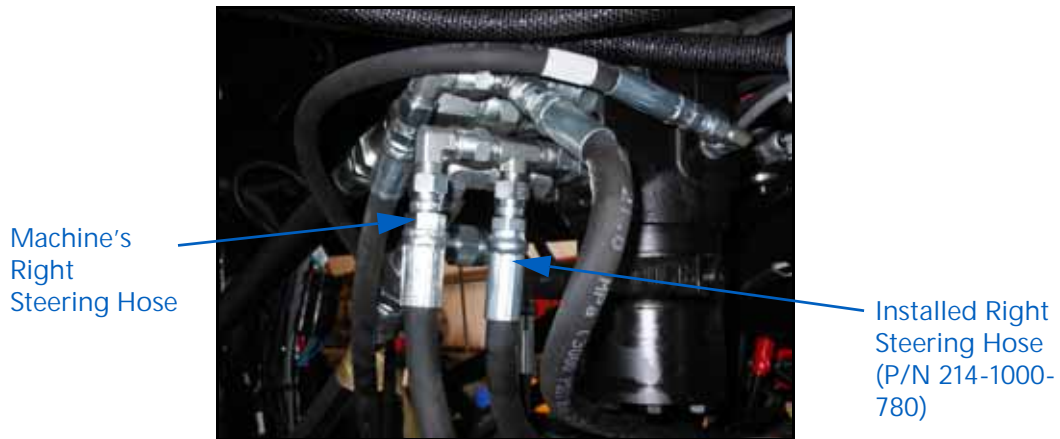

6. Install the straight end of the supplied hydraulic hose (P/N 214-1000-780) in the open port of the tee fitting.

FIGURE 10. Right Steering Hose Installed on Steering Valve



7. Connect the 90° end of the installed hydraulic hose to the fitting installed in Port B of the steering valve.

INSTALL THE PRESSURE AND TANK HOSES

FIGURE 11. Pressure Hose Installed on Steering Orbital

Installed Pressure
Hose (P/N 214-
1000-638)



Machine's
Pressure Hose

1. Remove the cap from the tee fitting installed in the pressure port (lower-left corner) of the steering orbital.
2. Install the 90° end of the supplied hydraulic hose (P/N 214-1000-638) in the open port of the tee fitting.



FIGURE 12. Pressure Hose Installed on Steering Valve



3. Connect the straight end of the installed hydraulic hose to the fitting installed in Port P of the steering valve (P/N 334-0003-088).

FIGURE 13. Tank Hose Installed on Steering Orbital



4. Remove the cap from the tee fitting installed in the pressure port (upper-left corner) of the steering orbital.
5. Install the -12 JIC end of the supplied hydraulic hose (P/N 214-1000-959) in the open port of the tee fitting.

FIGURE 14. Tank Hose Installed on Steering Valve



6. Connect the -10 JIC end of the installed hydraulic hose to the fitting installed in Port T of the steering valve.

INSTALL THE LOAD SENSE HOSES

1. Locate and disconnect the machine's load sense hose from the right side of the steering orbital.

FIGURE 15. LSPV Connection on Steering Valve



2. Connect the machine's load sense hose to the fitting installed in Port LSPV of the steering valve.

FIGURE 16. Load Sense Hose Installed on Steering Orbital



3. Install the straight end of the supplied hydraulic hose (P/N 214-1000-958) on the open load sense port on the steering orbital.

FIGURE 17. LS STEER Connection on Steering Valve



LS STEER
Connection on Side
of Steering Valve

4. Connect the 90° end of the installed hydraulic hose to the fitting installed in Port LS STEER of the steering valve.

HYDRAULIC DIAGRAM

Before SmarTrax Installation

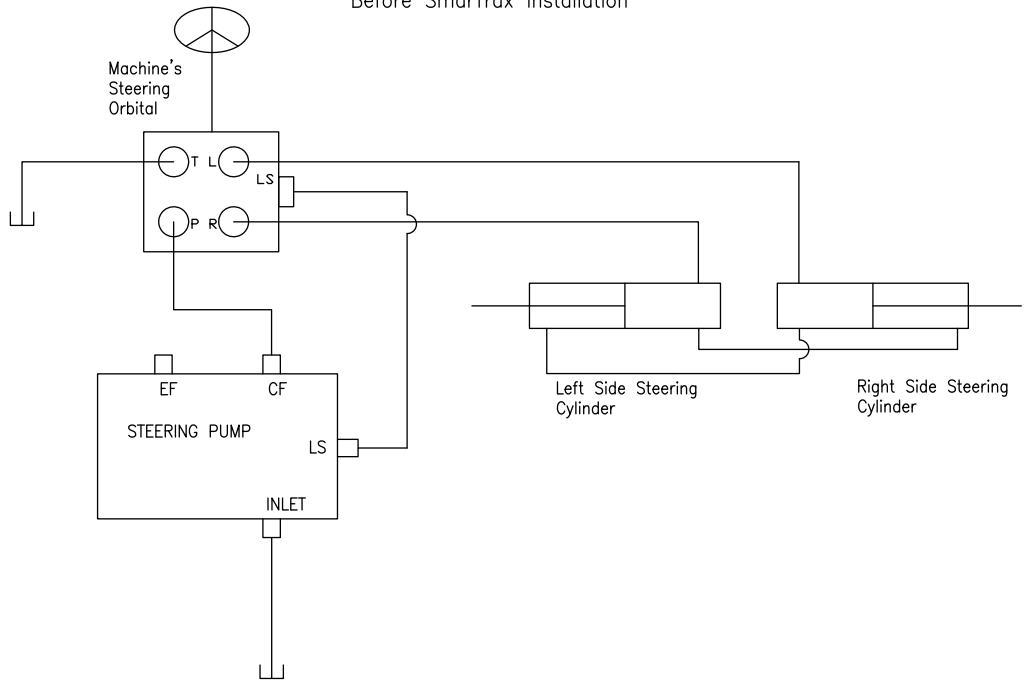

After SmarTrax Installation

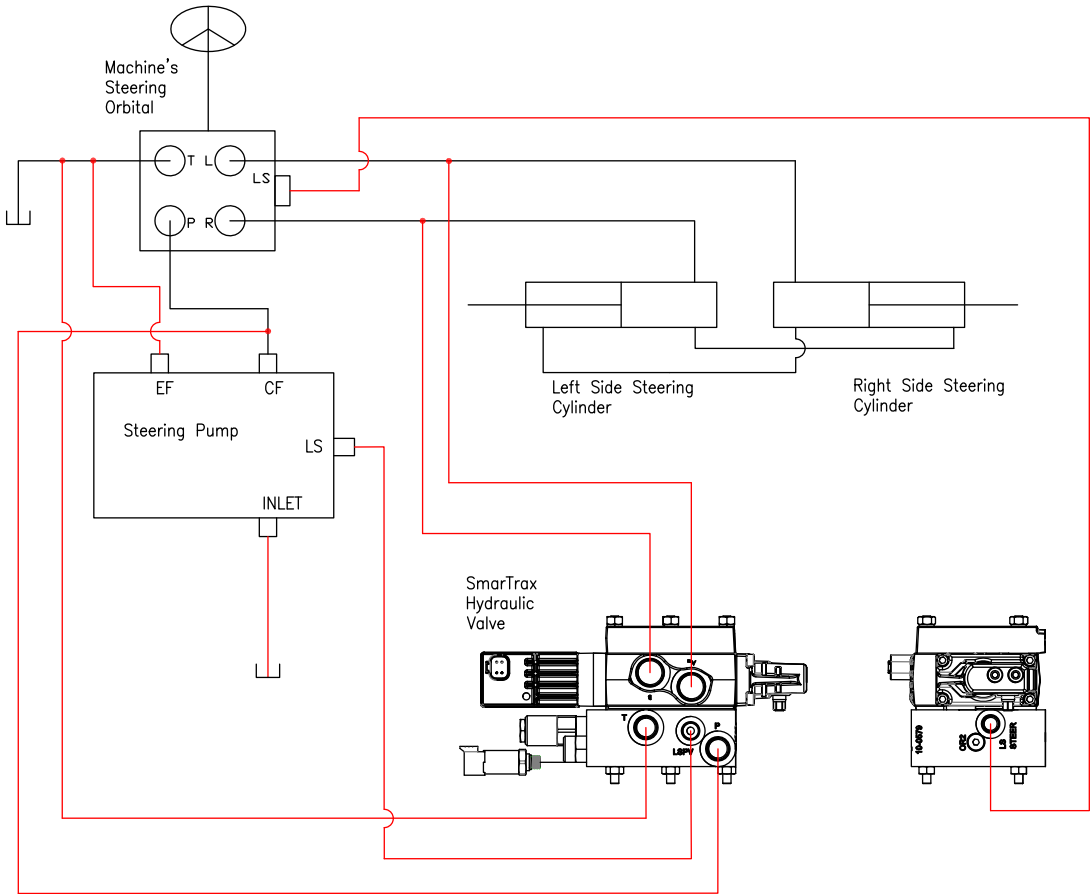

CHAPTER

5

WHEEL ANGLE SENSOR INSTALLATION

ASSEMBLE THE WAS

FIGURE 1. Wheel Angle Sensor



1. Install the M10 universal ball mounts (P/N 103-0001-029) and M29 jam nuts (P/N 312-1002-035) on both ends of the linear WAS (P/N 416-0001-052).
2. Loosen the nuts and ball mounts until the sensor is installed later in the procedure.

INSTALL THE WAS

1. Park the machine on a level surface with the wheels pointing straight forward.
2. Remove the nuts and clamp from the 3" x 3/8" - 16 U-bolt clamp.
3. Install the U-bolt clamp on the base end of the left steering cylinder, positioning the U-bolt so that the threaded ends point toward the front of the machine.

FIGURE 2. U-Bolt Pointing to Front of Machine



Front of Machine

4. Install the base end of the WAS on the top of the U-Bolt.
5. Use the provided hardware to install the WAS and the U-bolt clamp.

FIGURE 3. WAS and Clamp on U-Bolt



6. Remove the nuts and clamp from the 2" W x 5/16" - 18 U-bolt clamp.
7. Install the U-bolt clamp on the rod end of the left steering cylinder so the threaded ends of the U-bolt point up.

FIGURE 4. U-Bolt on Left Steering Cylinder



8. Use the provided hardware U-bolt, 3/8" long spacers, and 5/16" washers to install the WAS Rod mounting bracket.
9. Use the provided M10 x 60mm bolt, M10 lock nut, and 3/4" spacer to install the WAS rod end of the WAS rod mounting bracket in the middle hole of the WAS rod mounting bracket.

FIGURE 5. WAS Rod Mounting Bracket Installation



10. Turn the machine's wheels to the left and right locks to ensure the sensor is not over compressed or extended.
11. Tighten all mounting hardware.

CHAPTER

6

CAB COMPONENT INSTALLATION

RS1 INSTALLATION

1. Install the RS1 mounting bracket to the supplied RS1 using the supplied 1/4" - 20 hardware.

FIGURE 1. RS1 Mounting Bracket



2. Use the provided 5/16" - 18 lock nuts to assemble the RS1 latch bracket on the cab mounting bracket.

FIGURE 2. RS1 Secured to Cab Mounting Bracket

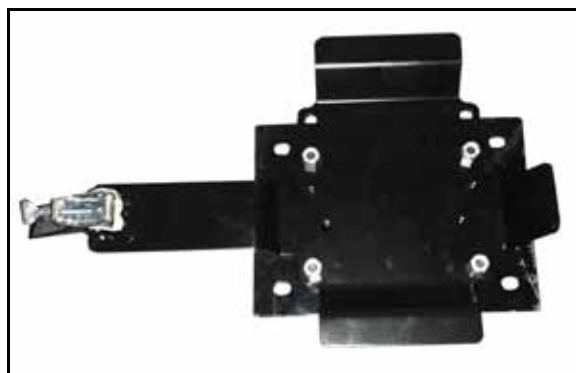

3. Identify the RS1 mounting location on the cab roof.

FIGURE 3. RS1 Mounting Location on Roof



4. Remove the machine's plate from the top of the roof.

NOTE: The plate is no longer needed.

5. Install the RS1 latch plate on the roof using the machine's fasteners.

FIGURE 4. Bracket Installed on Roof



6. Install the RS1 on the RS1 latch bracket.

FIGURE 5. RS1 Attached to Roof



NOTE: It may be necessary to adjust the latch in order to secure the RS1 unit.

CAB COMPONENT INSTALLATION

1. Use the provided 1/4" - 20 flanged nuts to install the HDU on the HDU mounting plate.

FIGURE 6. HDU Installed on Mounting Plate



2. Identify the HDU mounting location on the floor of the cab on the right side of the machine.

FIGURE 7. HDU Mounting Location



3. Use the provided machine hardware to mount the HDU mounting bracket on the floor with the connectors facing the seat.

FIGURE 8. Installed HDU

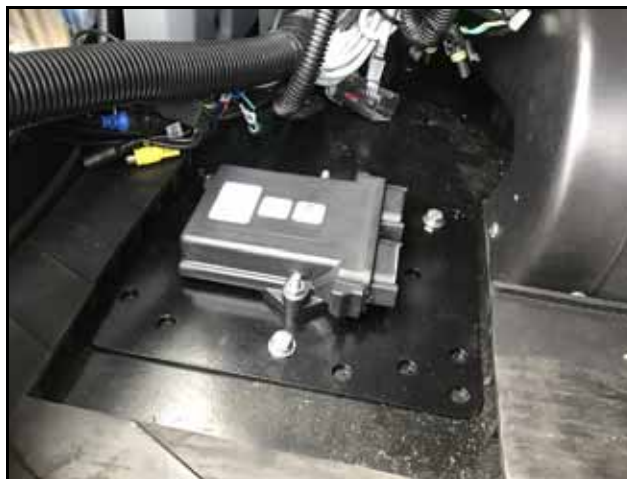

INSTALL THE MASTER SWITCH

1. Use the provided hardware to install the Master Switch (P/N 063-0173-961) in the provided enclosure.

FIGURE 9. Master Switch in Enclosure



2. Install the master switch in a convenient location using either self-tapping screws or double sided tape (not provided).

FIGURE 10. Installed Master Switch



INSTALL SYSTEM CABLES

HDU CABLE

1. Identify the HDU cable (P/N 115-4010-092).
2. Remove the right-rear cover off the machine.

FIGURE 11. Right-Rear Cab Access



3. Remove the bulkhead connector labeled RAVEN and pull it into the cab.

FIGURE 12. Raven Connector



4. Plug the mating connector of the HDU cable to the bulkhead in the cab.

FIGURE 13. HDU Cable Connection in the Cab



5. Install the other end of the bulkhead connector on the HDU cable into the machine's rear panel.

FIGURE 14. Bulkhead Connection



6. Route and connect the gray 12-pin connector on the HDU cable to the HDU.

FIGURE 15. 12-Pin Connected to HDUI



HDU SWITCH CABLE

1. Identify the HDU Switch Cable (P/N 115-4010-028).
2. Connect the 8-pin plug on the HDU switch cable to the receptacle on the HDU cable.
3. Connect the 4pin Master connector on the HDU switch cable into the master switch.

FIGURE 16. Master Cable Connected



4. Connect the 2-pin Engage connector on the HDU switch cable to the machine's mating connector labeled RS1/HDU.

FIGURE 17. 2-Pin Engage to SMARTTRAX Cable



NOTE: The two 12-pin Deutsch connectors on the HDU Switch cable are not used for this installation. Zip tie the two cables together and place in a convenient location.

VALVE CABLE

1. Identify the HDU Valve cable (P/N 115-4010-044).
2. Connect the 12-pin connector on the HDU valve cable to the mating connector on the HDU.

FIGURE 18. 12-Pin HDU Connection



3. Connect the 2-pin connector on the HDU valve cable into the mating connector on the HDU cable.

FIGURE 19. 2-Pin Connector on the HDU Valve Cable



4. Route the HDU valve cable outside of the cab using the circular hole in the cab floor.

FIGURE 20. Feeding HDU Cable out of Cab



5. Route the HDU valve cable to the steering valve.
6. Plug the 3-pin connector into the pressure transducer and the 4-pin connector into the valve.

FIGURE 21. Valve Connections



7. Route and connect the WAS connector on the HDU valve cable to the WAS.

FIGURE 22. WAS Cable Connected to WAS



RS1 CABLE

1. Identify the RS1 Cable (P/N 115-4010-068).
2. Connect the round bulkhead connector to the mating connector on the HDU cable that was installed in the rear of the machine.

FIGURE 23. Bulkhead Connector to HDU Cable



3. Connect the end of the RS1 cable to the machine's mating connector.

FIGURE 24. RS1 Connected to Machine's Mating Connector



4. Route the 12-pin connector up to the RS1. Secure the cable with zip ties and cable clamps.

FIGURE 25. Cable Routed to RS1



5. Plug the 12-pin connector into the mating connector on the RS1.

FIGURE 26. 12-Pin Connected to RS1



NOTE: The 4-pin connector on the RS1 cable will not be used. Leave the dust cap on the connector.

NOTE: If an ISO bed is on the machine, remove the terminator on the RS1 cable and plug the terminator connector into the provided dust cap. If an ISO bed is not being utilized, leave the terminator on the cable.

ROUTINE OPERATION

Locate and identify the machine's master switch on the control panel and the resume switch on the joystick as they are required for RS1 system operation.

FIGURE 27. Resume Switch Location



Refer to the Raven RS1 Guidance and Steering Calibration and Operation Manual (P/N 016-4010-001) for instructions on calibrating the RS1 system, adjusting system settings, and system operation.

SYSTEM DIAGRAMS

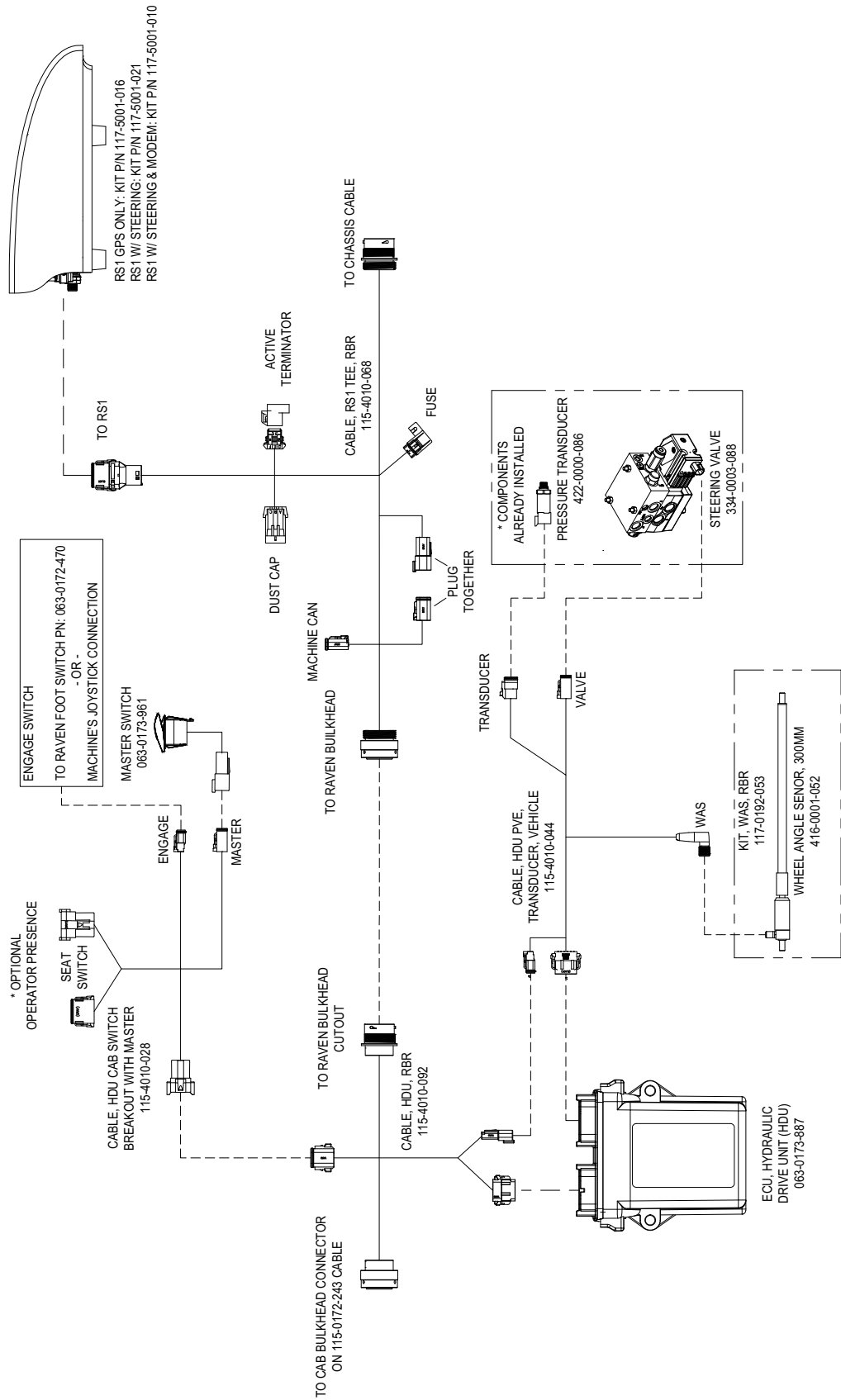

APPENDIX

KITS LISTS

A

KITS

The following kits are included in this appendix:

TABLE 1. SmarTrax to RS1 Retrofit Kits

Description	Kit Number
Kit, WAS, RBR	117-0192-053
Kit, HDU w/o Hydraulics, STX to RS1 Retrofit, RBR Vector, MY 2016-18	117-5035-058

TABLE 2. RS1/HDU Kits

Description	Kit Number
Kit, WAS, RBR	117-0192-053
Kit, Hydraulic, PVG Dynamic Load Sense	117-0199-126
Kit, HDU, w/ Hydraulics, RBR Vector, MY 2016-18	117-5035-002

C

- Cab Component Installation 29
- System Diagram 43

H

- Hydraulic System Installation 13
 - Hydraulic Diagram 23
 - Installing Fittings in the SmarTrax Valve 14
 - Installing Left and Right Steering Hoses 16
 - Installing Load Sense Hoses 21
 - Installing Pressure and Tank Hoses 19
 - Mount the Steering Valve 15

I

- Introduction
 - Preparing for Installation 5
 - Point of Reference 6
 - Recommendations 6
 - Updates 7

K

- Kit Contents 7

R

- RS1 Installation 29

S

- SmarTrax Removal 9
- System Diagram 10

W

- Wheel Angle Sensor Installation 25

LIMITED WARRANTY

WHAT DOES THIS WARRANTY COVER?

This warranty covers all defects in workmanship or materials in your Raven Applied Technology Division product under normal use, maintenance, and service when used for intended purpose.

HOW LONG IS THE COVERAGE PERIOD?

Raven Applied Technology products are covered by this warranty for 12 months from the date of retail sale. In no case will the Limited Warranty period exceed 24 months from the date the product was issued by Raven Industries Applied Technology Division. This warranty coverage applies only to the original owner and is non-transferable.

HOW CAN I GET SERVICE?

Bring the defective part and proof of purchase to your Raven dealer. If the dealer approves the warranty claim, the dealer will process the claim and send it to Raven Industries for final approval. The freight cost to Raven Industries will be the customer's responsibility. The Return Materials Authorization (RMA) number must appear on the box and all documentation (including proof of purchase) must be included inside the box to be sent to Raven Industries.

WHAT WILL RAVEN INDUSTRIES DO?

Upon confirmation of the warranty claim, Raven Industries will (at our discretion) repair or replace the defective product and pay for the standard return freight, regardless of the inbound shipping method. Expedited freight is available at the customer's expense.

WHAT IS NOT COVERED BY THIS WARRANTY?

Raven Industries will not assume any expense or liability for repairs made outside our facilities without written consent. Raven Industries is not responsible for damage to any associated equipment or products and will not be liable for loss of profit, labor, or other damages. The obligation of this warranty is in lieu of all other warranties, expressed or implied, and no person or organization is authorized to assume any liability for Raven Industries.

Damages caused by normal wear and tear, misuse, abuse, neglect, accident, or improper installation and maintenance are not covered by this warranty.

EXTENDED WARRANTY

WHAT DOES THIS WARRANTY COVER?

This warranty covers all defects in workmanship or materials in your Raven Applied Technology Division product under normal use, maintenance, and service when used for intended purpose.

DO I NEED TO REGISTER MY PRODUCT TO QUALIFY FOR THE EXTENDED WARRANTY?

Yes. Products/systems must be registered within 30 days of retail sale to receive coverage under the Extended Warranty. If the component does not have a serial tag, the kit it came in must be registered instead.

WHERE CAN I REGISTER MY PRODUCT FOR THE EXTENDED WARRANTY?

To register, go online to www.ravenhelp.com and select Product Registration.

HOW LONG IS THE EXTENDED WARRANTY COVERAGE PERIOD?

Raven Applied Technology products that have been registered online are covered for an additional 12 months beyond the Limited Warranty for a total coverage period of 24 months from the date of retail sale. In no case will the Extended Warranty period exceed 36 months from the date the product was issued by Raven Industries Applied Technology division. This Extended Warranty coverage applies only to the original owner and is non-transferable.

HOW CAN I GET SERVICE?

Bring the defective part and proof of purchase to your Raven dealer. If the dealer approves the warranty claim, the dealer will process the claim and send it to Raven Industries for final approval. The freight cost to Raven Industries will be the customer's responsibility. The Return Materials Authorization (RMA) number must appear on the box and all documentation (including proof of purchase) must be included inside the box to be sent to Raven Industries. In addition, the words "Extended Warranty" must appear on the box and all documentation if the failure is between 12 and 24 months from the retail sale.

WHAT WILL RAVEN INDUSTRIES DO?

Upon confirmation of the product's registration for the Extended Warranty and the claim itself, Raven Industries will (at our discretion) repair or replace the defective product and pay for the standard return freight, regardless of the inbound shipping method. Expedited freight is available at the customer's expense.

WHAT IS NOT COVERED BY THE EXTENDED WARRANTY?

Raven Industries will not assume any expense or liability for repairs made outside our facilities without written consent. Raven Industries is not responsible for damage to any associated equipment or products and will not be liable for loss of profit, labor, or other damages. Cables, hoses, software enhancements, and remanufactured items are not covered by this Extended Warranty. The obligation of this warranty is in lieu of all other warranties, expressed or implied, and no person or organization is authorized to assume any liability for Raven Industries.

Damages caused by normal wear and tear, misuse, abuse, neglect, accident, or improper installation and maintenance are not covered by this warranty.