

ENVIZIO PRO (II) SYSTEM DRAWING WITH KITS, CABLE OPTIONS, SMARTYIELD PRO

115-9000-016....CABLE, TEE, HEADER HEIGHT SENSOR, AMP SUPERSEAL
(USED ON CERTAIN MODELS OF GLEANER, MASSEY FERGUSON, CHALLENGER, AND LEXION)

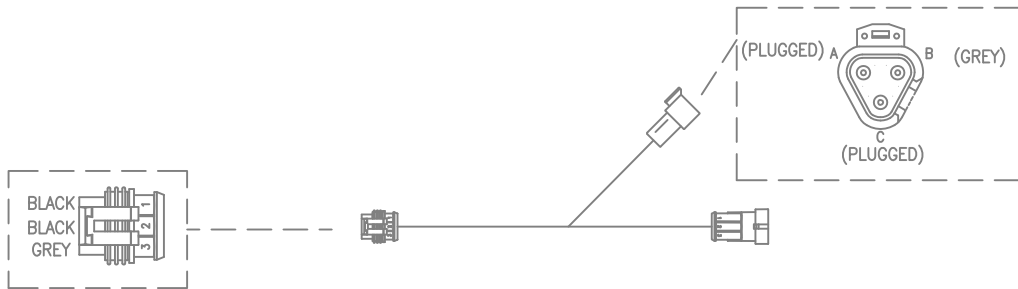

115-9000-017....CABLE, TEE, HEADER HEIGHT SENSOR, DEUTSCH DT.
(USED ON CERTAIN MODELS OF CASE COMBINES AND AFTERMARKET SENSORS)

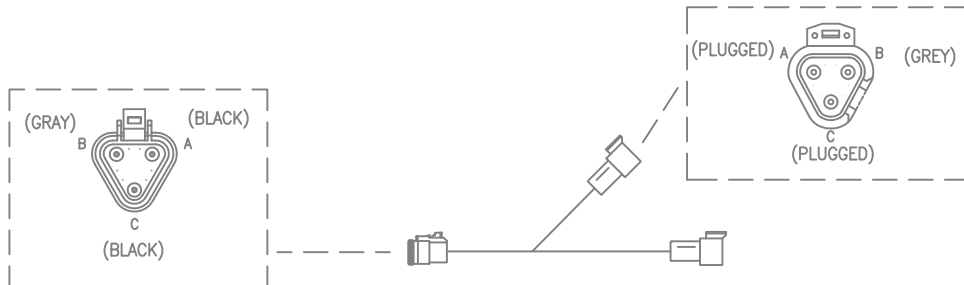

115-9000-018....CABLE, TEE, HEADER HEIGHT SENSOR, AMP SUPER SEAL
(USED ON CERTAIN MODELS OF CASE)

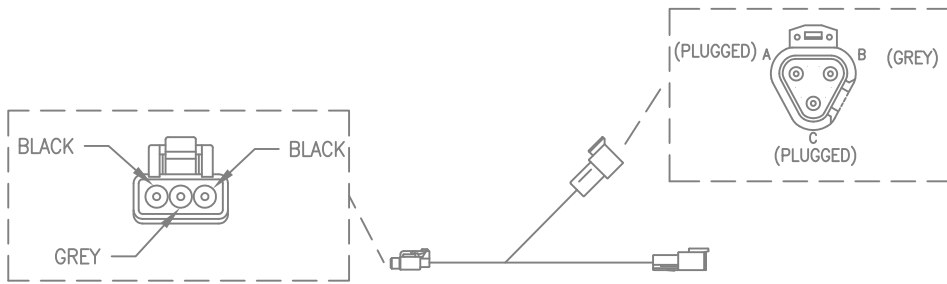

115-9000-019....CABLE, TEE, HEADER HEIGHT SENSOR, WEATHERPACK
FEMALE PINS, MALE SHROUD
(USED ON AFTERMARKET SENSORS)

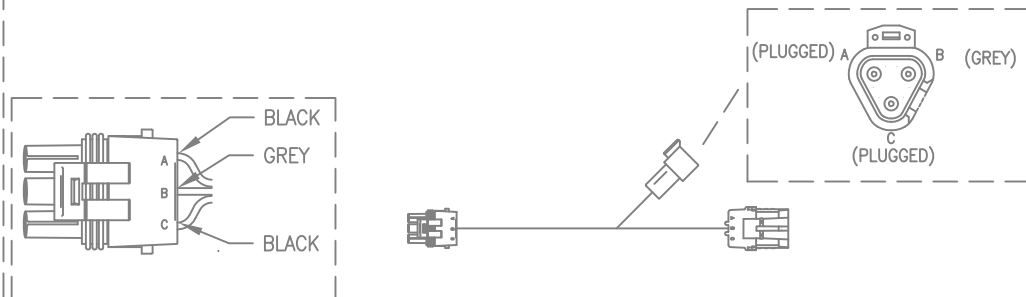

RELEASED DATE	ECO NO.	PROD. MGR.	SERV.	PROD. CHAMP.	ENG.	DRAFT.	REV.	DRAWING NO.
11/06/13	E22361	DSP2	SDK	SDK	BSG	BJH	A	054-9000-007
12/12/13	E22527	DSP2	SDK	SDK	BSG	BJH	B	054-9000-007

ENVIZIO PRO (II) SYSTEM DRAWING WITH KITS, CABLE OPTIONS, SMARTYIELD PRO

115-9000-021....CABLE, TEE, HEADER HEIGHT SENSOR, WEATHERPACK
 MALE PINS MALE SHROUD
 (USED ON CERTAIN MODELS DEERE, NEW HOLLAND AND CASE COMBINES)

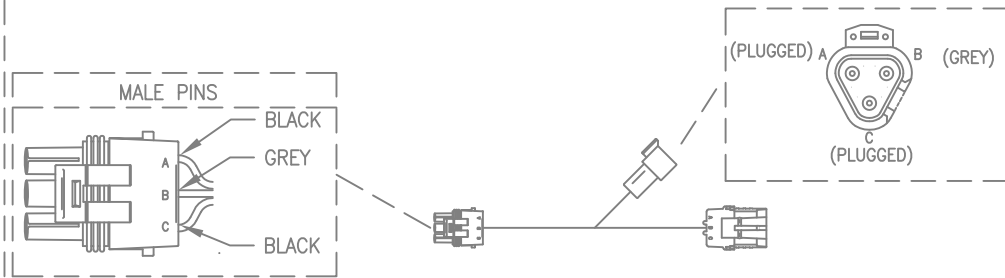

115-9000-023....CABLE, ADAPTER, HEADER HEIGHT SENSOR, AMPSEAL
 (JOHN DEERE S SERIES)

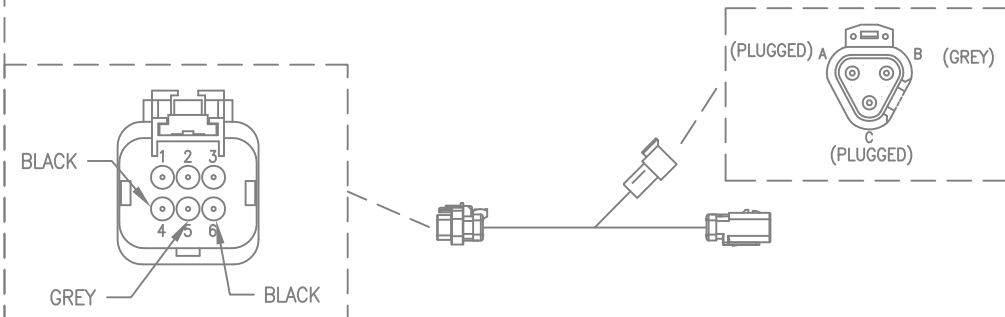

117-9000-007....KIT, ROTARY HEADER HEIGHT SENSOR

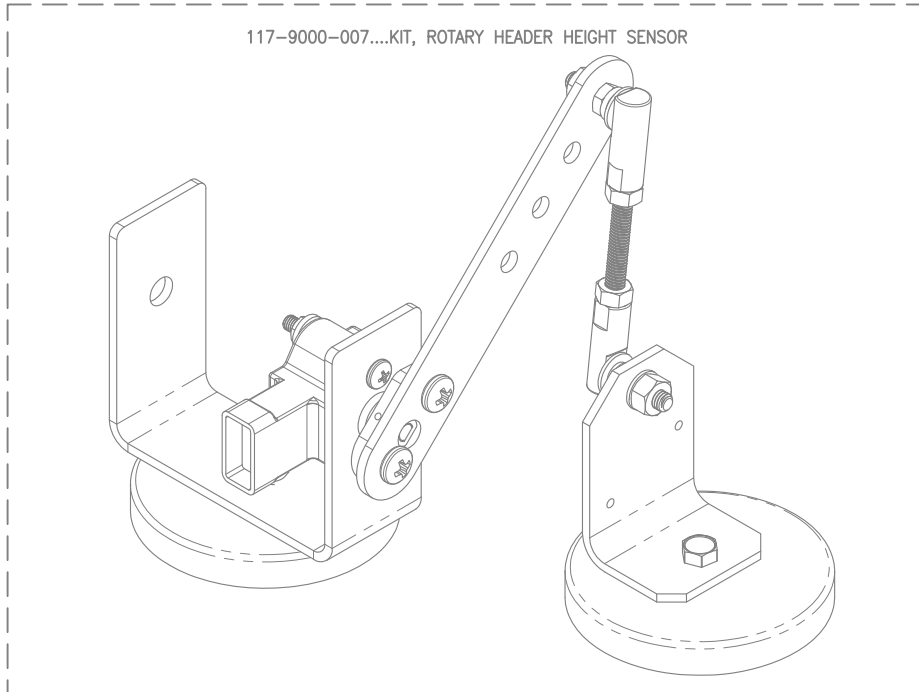

RELEASED DATE	ECO NO.	PROD. MGR.	SERV.	PROD. CHAMP.	ENG.	DRAFT.	REV.	DRAWING NO.
11/06/13	E22361	DSP2	SDK	SDK	BSG	BJH	A	054-9000-007
12/12/13	E22527	DSP2	SDK	SDK	BSG	BJH	B	054-9000-007