

CAN ACCUFLOW HP, 3 SECTION BAR

REFER TO SAFETY SECTION IN MANUAL

CAN ACCUFLOW HP 3 SECTION BAR ELECTRONICS KIT
117-5300-001

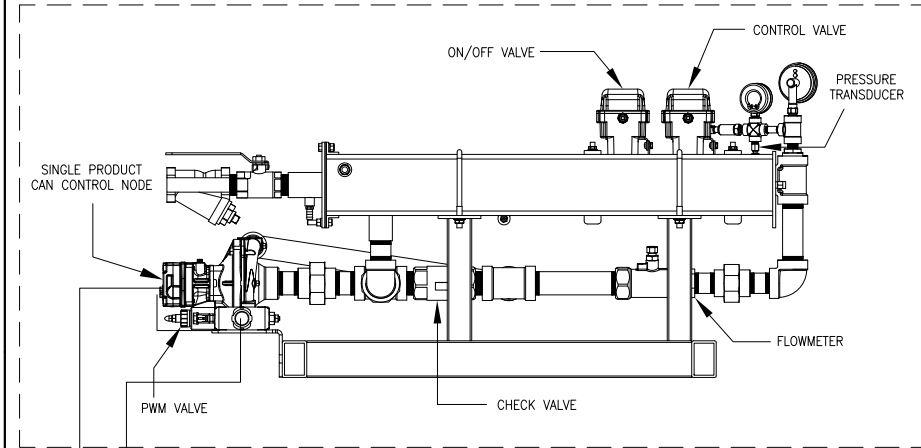

ACCUFLOW HP KIT
TWO VALVE: 117-0171-392
FAST VALVE: 117-0171-393

VAPOR TUBES SOLD SEPERATELY
3/4"- 117-0171-409 (2 TUBE KIT)
1/2"- 117-0171-410 (4 TUBE KIT)

T P
TO TRACTOR HYDRAULICS

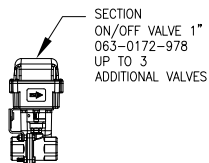

SECTION ON/OFF VALVE 1"
063-0172-978
UP TO 3 ADDITIONAL VALVES

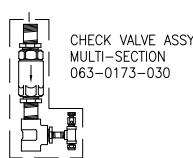

CHECK VALVE ASSY
MULTI-SECTION
063-0173-030

ON/OFF VALVE EXTENSION CABLES: (OPTIONAL)

6': 115-0171-832
12': 115-0171-833
24': 115-0171-834

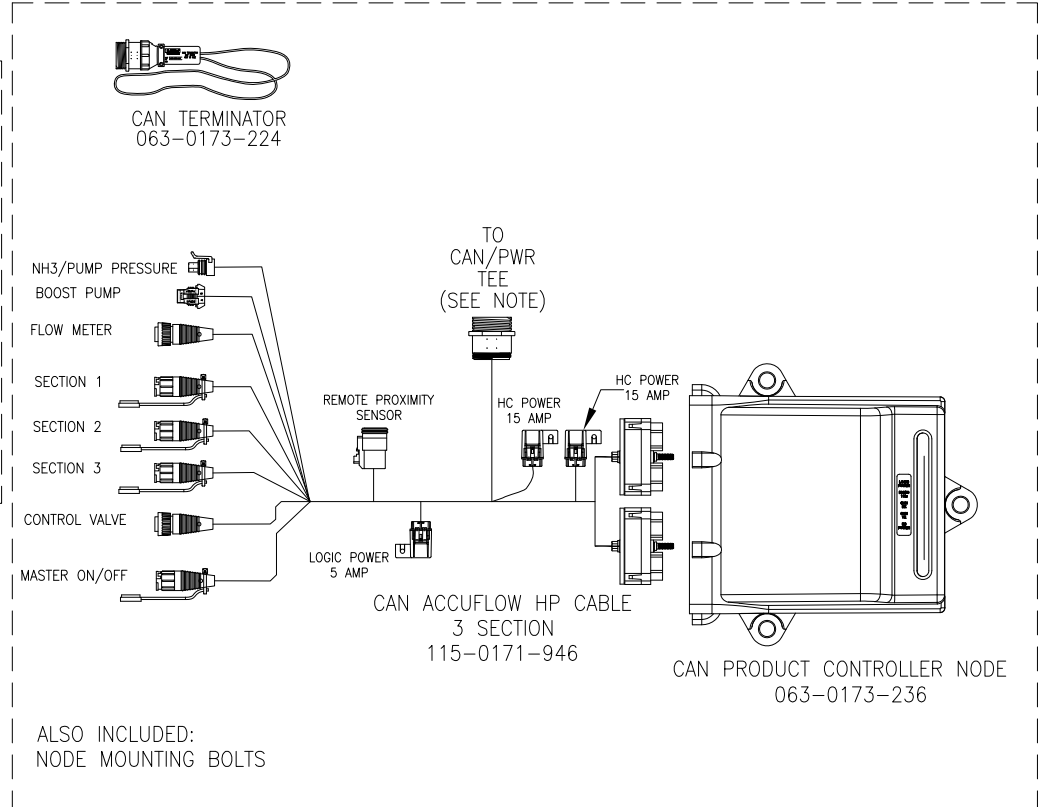

CAN TERMINATOR
063-0173-224

TO CAN/PWR TEE (SEE NOTE)

REMOTE PROXIMITY SENSOR

LOGIC POWER 5 AMP

CAN ACCUFLOW HP CABLE
3 SECTION
115-0171-946

HC POWER 15 AMP

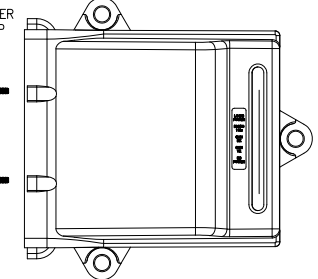

CAN PRODUCT CONTROLLER NODE
063-0173-236

ALSO INCLUDED:
NODE MOUNTING BOLTS

Optional:

PROXIMITY SENSOR KIT
117-0171-298

PROX SENSOR EXTENSION
CABLE, 20'
115-0171-501

NOTE:

REFER TO DWG. 054-5000-001 FOR OTHER SYSTEM COMPONENTS.

PURCHASE CAN/POWER IMPLEMENT TEE CABLE SEPARATELY.

RELEASED DATE	ECO NO.	PROD. MGR.	SERV. MGR.	PROD. CHAMP.	ENG.	DRAFT.	REV.	DRAWING NO.
10/18/10	E16352	JAB	AT	GLE	CRS	MAP	A	054-5300-001
5/26/11	E17536	JAB	TAC	GLE	CRS	AJK2	B	054-5300-001

CAN ACCUFLOW, 3 SECTION BAR

ACCUFLOW KIT, TWO VALVE
117-0171-384 -KIT INCLUDES SPACE SAVER KIT (SHOWN WITHOUT SPACE SAVER KIT)

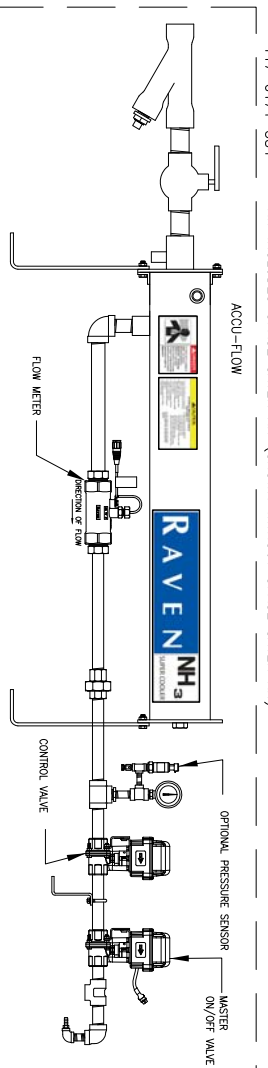

CAN ACCUFLOW HP 3 SECTION BAR ELECTRONICS KIT
117-5300-001

REFER TO SAFETY SECTION IN MANUAL

VAPOR TUBES SOLD SEPARATELY
3/4" - 117-0171-409 (2 TUBE KIT)
1/2" - 117-0171-410 (4 TUBE KIT)

ACCUFLOW KIT, FAST VALVE -KIT INCLUDES SPACE SAVER KIT (SHOWN WITHOUT SPACE SAVER KIT)
117-0171-386

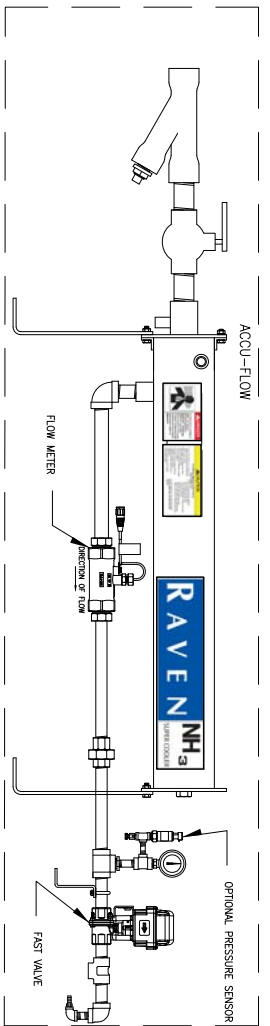

VAPOR TUBES SOLD SEPARATELY
3/4" - 117-0171-409 (2 TUBE KIT)
1/2" - 117-0171-410 (4 TUBE KIT)

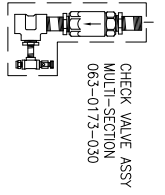
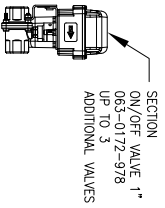

ON/OFF VALVE EXTENSION CABLES: (OPTIONAL)

- 6': 115-0171-832
- 12': 115-0171-833
- 24': 115-0171-834

NODE MOUNTING KIT (OPTIONAL): 117-0171-299

NOTE:

REFER TO DWG. 054-5000-001 FOR OTHER SYSTEM COMPONENTS.

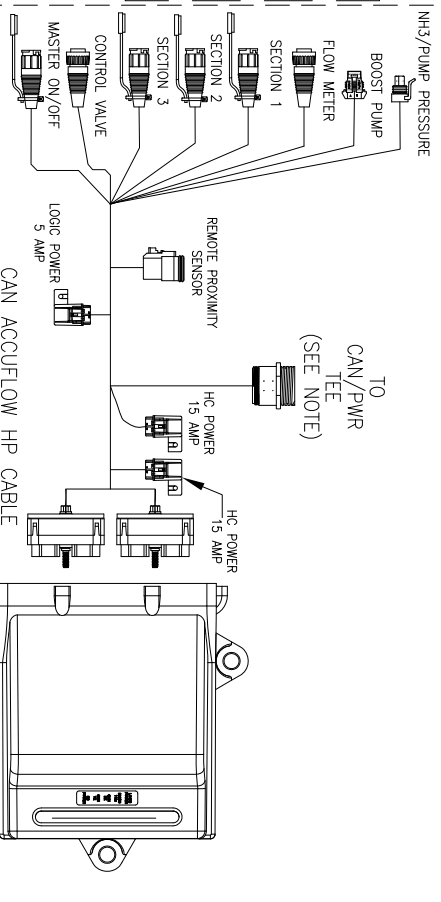
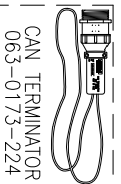

ALSO INCLUDED:
NODE MOUNTING BOLTS

Optional:

- PROXIMITY SENSOR KIT 117-0171-298
- PROX SENSOR EXTENSION CABLE, 20' 115-0171-501

RELEASED DATE	ECO NO.	PROD. MGR.	SERV. MGR.	PROD. CHAMP.	ENG.	DRAFT.	REV.	DRAWING NO.
10/18/10	E16352	JAB	AT	GLE	CRS	MAP	A	054-5300-001
5/26/11	E17536	JAB	TAC	GLE	CRS	AIK2	B	054-5300-001