

CAN ACCUROW ONLY SYSTEMS

ACCUROW KITS:

- 4-16 ROW 117-3001-001
- 2 CLUTCH MOUNTED 117-3001-002
- 2 CLUTCH DRAWN 117-3001-003
- 3 CLUTCH DRAWN 117-3001-004
- 4 CLUTCH DRAWN 117-3001-005

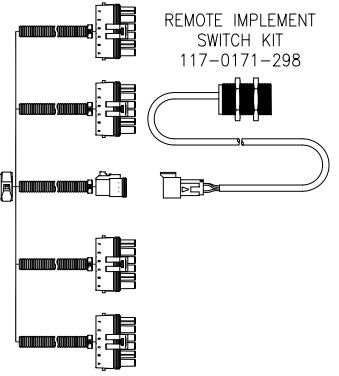
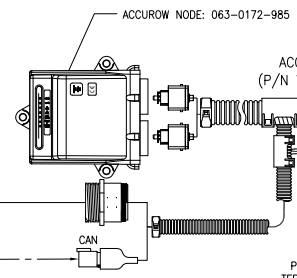
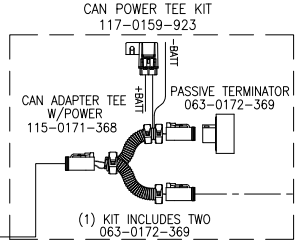
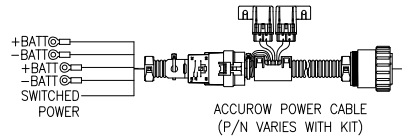

KIT ALSO INCLUDES:

- NODE MAG MOUNT KIT: 117-0171-299
- ACCUROW INSTALLATION MANUAL: 016-3001-001
- ACCUROW CALIBRATION & OPERATION MANUAL: 016-0171-275

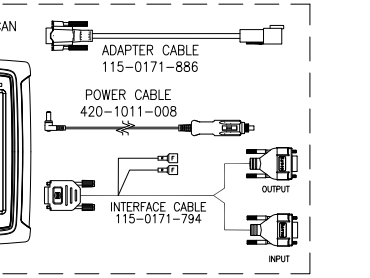
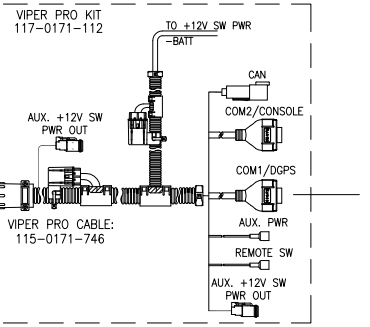
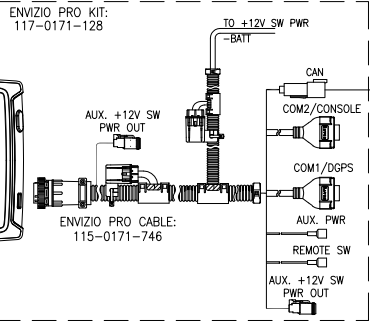
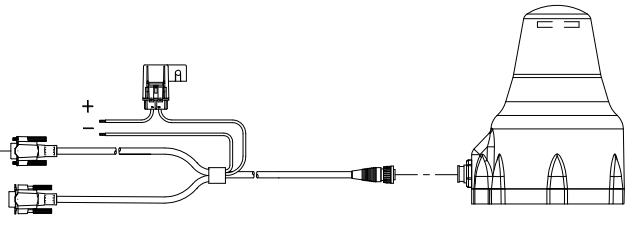

RELEASED DATE	ECO NO.	PROD. MGR.	SERV. MGR.	PROD. CHAMP.	ENG.	DRAFT.	REV.	DRAWING NO.
10/18/10	E16352	DSP	AT	GLE	CRS	MAP	A	054-3001-005
7/29/15	26259	NGL	SAH	-	DAS	RRS	B	054-3001-005