

SCS4400/SIDEKICK PRO TO SCS 440 CABLES

KIT
117-0171-565

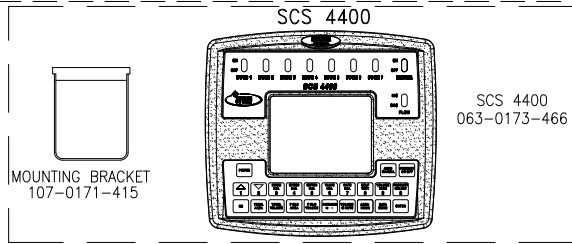

KIT, PHOENIX 10
117-0171-458

PHOENIX 10
063-0172-988

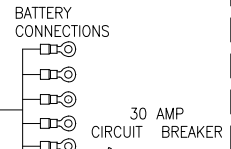
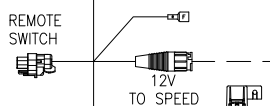
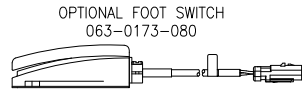
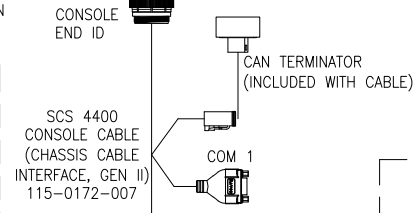
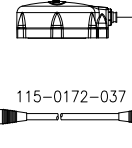

HITCH CONNECTIONS

TO 16 PIN PRODUCT CABLE

PRESSURE SENSOR CABLES

6': 115-0171-235
12': 115-0171-151
37': 115-0171-224
44': 115-0171-296

EXTENSION CABLES

12': 115-0159-856
24': 115-0159-857

CAN/Power Tee Extension Cable for Each Node

115-0171-928 Cable, CAN/Power Implement Tee, 12" Lg
115-0171-951 Cable, CAN/Power Implement Extension Tee, 6' Lg
115-0171-916 Cable, CAN/Power Implement Extension Tee, 12' Lg
115-0171-917 Cable, CAN/Power Implement Extension Tee, 24' Lg
115-0171-934 Cable, CAN/Power Implement Extension Tee, 36' Lg

OPTIONAL PRESSURE SENSOR
422-0000-090

FLOW CABLES

6': 115-0171-086
12': 115-0171-129

CABLE SIDEKICK PRO W/AGITATOR & PUMP RENSE
115-0172-191

FLOW EXTENSION CABLES

6': 115-0159-016
12': 115-0159-017
24': 115-0159-019
36.5': 115-0171-544

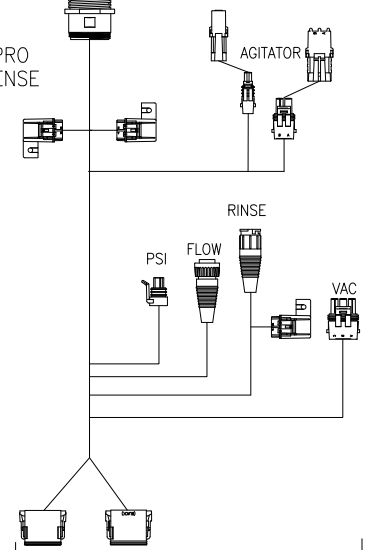
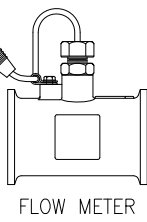
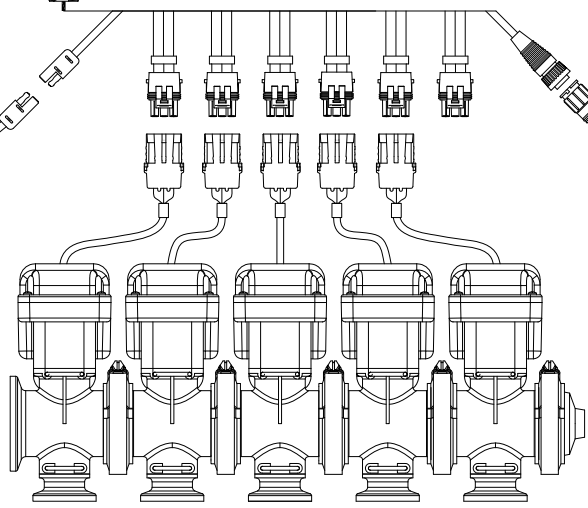
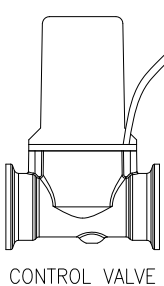

NOTE:
1. REFER TO DWG. 054-5000-001 FOR OTHER SYSTEM COMPONENTS.
2. SPEED CONNECTION FOR USE WITH 12V SENSORS ONLY.

RELEASED DATE	ECO NO.	PROD. MGR.	SERV. MGR.	PROD. CHAMP.	ENG.	DRAFT.	REV.	DRAWING NO.
11/25/13	E22425	GLE	LLM2	BCN	NAP	JJP	A	054-2840-018