

ALL TRACTORS

Antenna Height Above Ground: _____

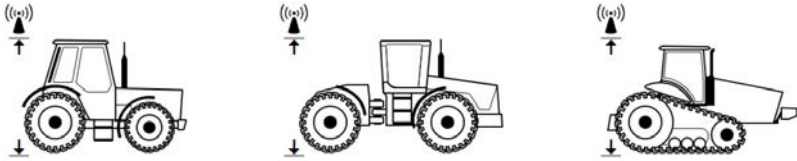

CONVENTIONAL TRACTOR

Antenna Offset from Center:

Antenna to Rear Axle:

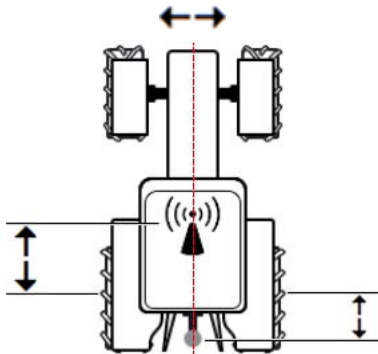

Rear Axle to Hitch:

Hitch Offset from Center:

ARTICULATED TRACTOR

Antenna Offset from Center:

Front Axle to Pivot:

Rear Axle to Pivot:

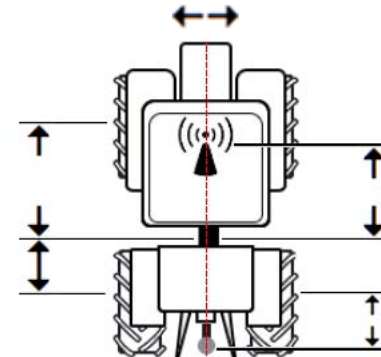

Pivot to Antenna:

Rear Axle to Hitch:

Hitch Offset from Center:

TRACKED TRACTOR

Antenna Offset from Center:

Track Center to Antenna:

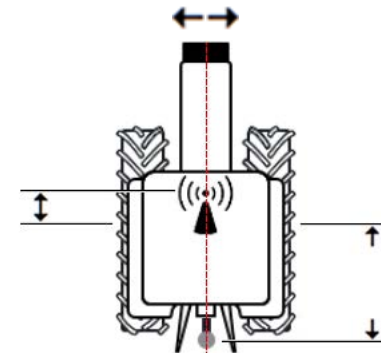

Track Center to Hitch:

Hitch Offset from Center:

SELF-PROPELLED SPRAYERS



Antenna Offset From Center:

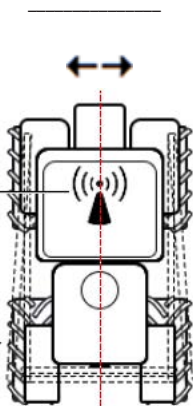

Antenna to Rear Axle:



MOUNTED EQUIPMENT (SPRAYERS AND TRACTORS)

Enter the name and details for the mounted equipment. Sprayers would be the spray boom sections and tractors would be the 3-point mounted implement.

<enter name>

Total Width **0.00** ft

Number Of Sections **1**

Guidance Width **0.00** ft

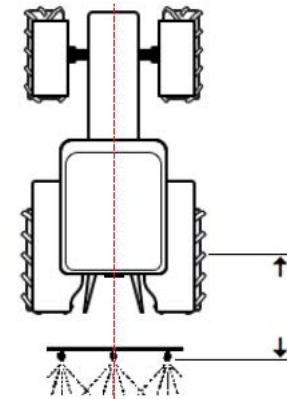

Axle to Equipment:

Equipment Offset From Center:



DRAWN EQUIPMENT (2 WHEEL)

Enter the name and details for the drawn cart. You will also need to mount any equipment to the cart.

<enter name>

Total Width ft

Number Of Sections

Guidance Width ft

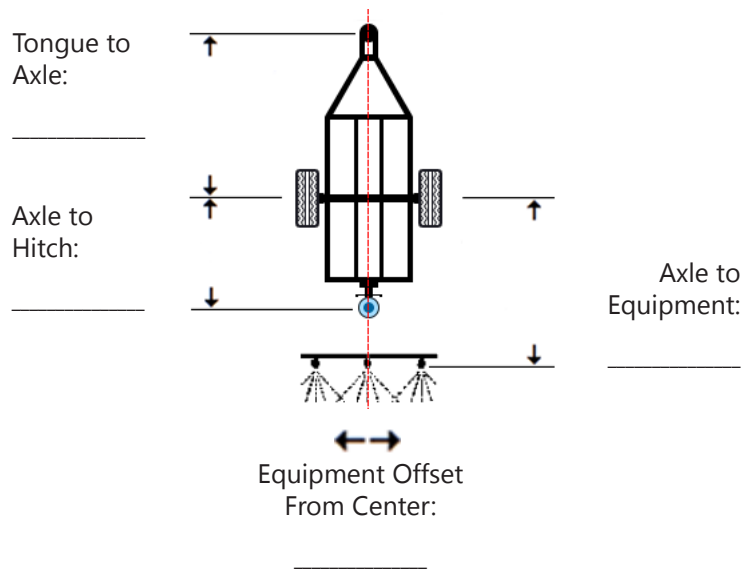

DRAWN EQUIPMENT (4 WHEEL)

Enter the name and details for the drawn cart. You will also need to mount any equipment to the cart.

<enter name>

Total Width ft

Number Of Sections

Guidance Width ft

