

RAVEN ISOBUS CABLING

SECTION 1: IN-CAB/TRACTOR COMPONENTS

NO EXISTING ISOBUS- OPTION A: CUSTOMIZABLE LENGTHS

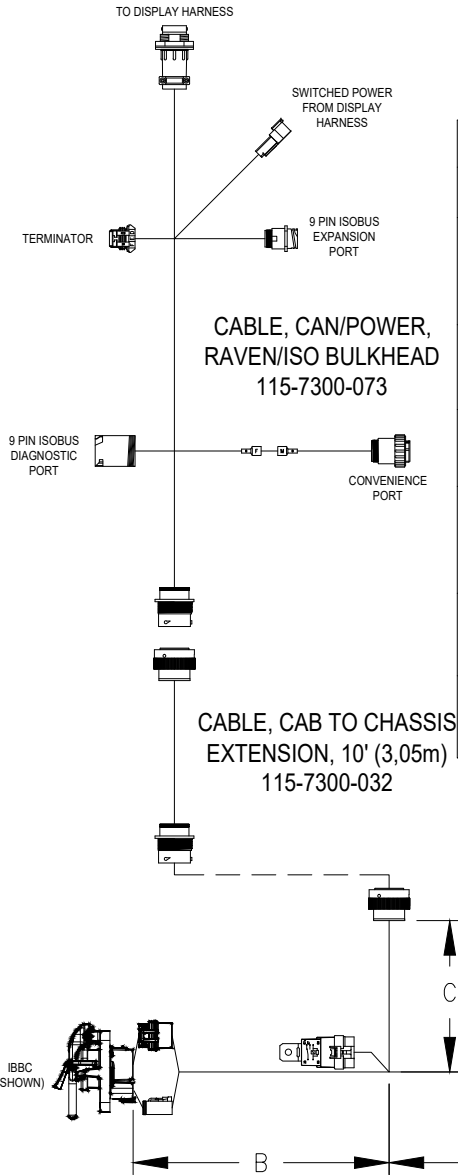

ISOBUS CHASSIS CABLE OPTIONS							
USE CASE	APPROVED MODELS	IBBC RAVEN P/N	GEN I RAVEN P/N	GEN 3 RAVEN P/N	A	B	C
GENERIC LARGE FRAME TRACTORS		115-7300-055	N/A	N/A	15' (9,5m)	6' (1,8m)	4' (1,2m)
TRACTORS W/ FRONT MOUNT BATTERY	CAT CHALLENGER MT 700, 800, 900; JD SMALL FRAME SERIES 6X20, 6X30, 7220 TO 7520, 7230 TO 7530	115-7300-069	115-7100-021	115-7300-001	21' (6,4m)	6' (1,8m)	4' (1,2m)
GENERIC 4WD TRACTORS	JD, CNH, BUHLER 4WD	115-7300-070	115-7100-022	115-7300-002	9.5' (2,9m)	12' (3,6m)	6.5' (2,0m)
GENERIC ROW CROP TRACTORS	CAT CHALLENGER MT500, 600; CNH ROW CROP; JD 7X00, 7X10	115-7300-071	115-7100-023	115-7300-003	7' (2,15m)	6' (1,8m)	7' (2,15m)
LARGE FRAME ROW CROP TRACTORS	JD LARGE FRAME SERIES 8X00, 8X10, 8X20, 8X30, 7620 TO 7920; 7630 TO 7930	115-7300-072	115-7100-024	115-7300-004	8' (2,4m)	4' (1,2m)	4' (1,2m)
GENERIC SMALL FRAME TRACTORS		N/A	115-7100-025	115-7300-033	8' (2,4m)	4' (1,2m)	2' (0,6m)

NOTE: REFER TO 054-6010-002
FOR DISPLAY HARNESS OPTIONS.

RELEASED DATE	ECO #	REV.	DRAWING NO.
9/16/19	33988	D	054-7000-002
12/3/20	36523	E	054-7000-002

RAVEN ISOBUS CABLING

SECTION 1: IN-CAB/TRACTOR COMPONENTS

OPTION B: NO EXISTING ISOBUS- FIXED LENGTH

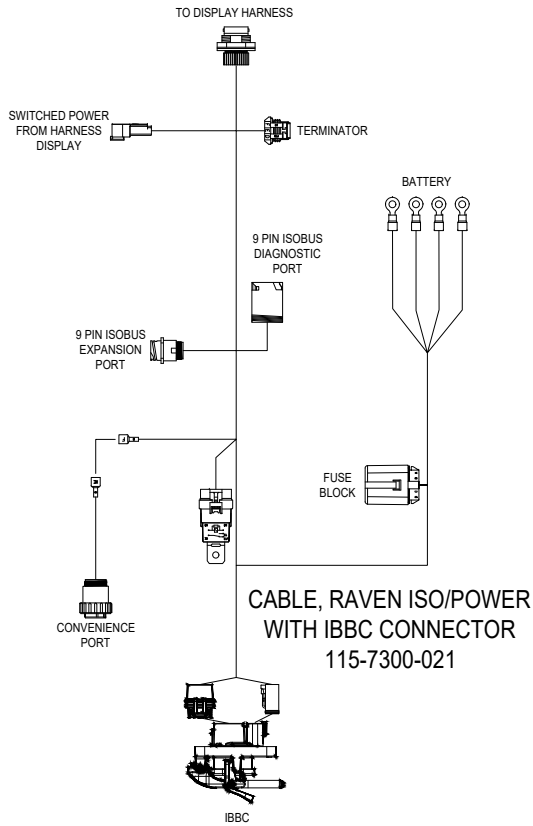

CABLE, RAVEN ISO/POWER WITH IBBC CONNECTOR
115-7300-021

EXISTING OPTION C: ISOBUS-GENERIC

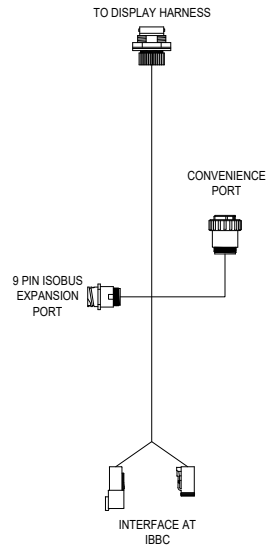

CABLE, CAN/PWR, OEM ISO TO RAVEN ISO BULKHEAD
115-7300-022

CNHi SPECIFIC OPTIONS

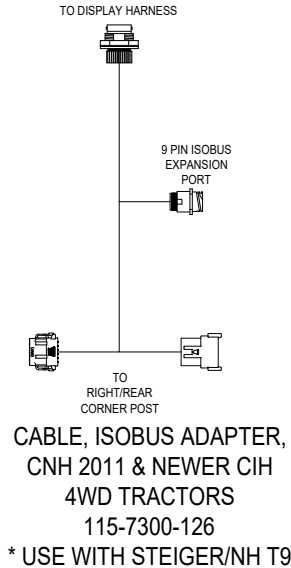

CABLE, ISOBUS ADAPTER, CNH 2011 & NEWER CIH 4WD TRACTORS
115-7300-126
* USE WITH STEIGER/NH T9

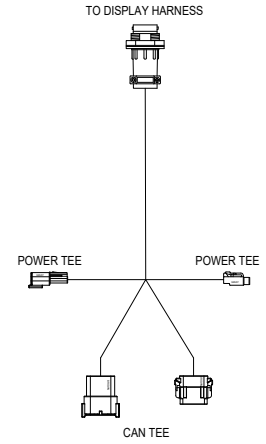

CABLE, RS1, CASE IH MAGNUM, LARGE FRAME
115-4010-085
* USE WITH MAGNUM/NH T8 2015 & NEWER

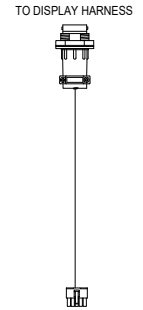

CABLE, CONSOLE, CASE MAGNUM/STEIGER
115-7300-154
* USE WITH MAGNUM/NH T8 TRACTORS IF REMOVING PRO700 DISPLAY

AGCO SPECIFIC OPTIONS

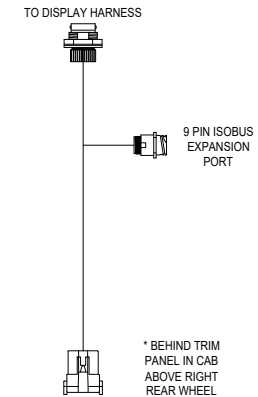

CABLE, ISOBUS DISPLAY ADAPTER, AGCO TRACTORS
115-7300-142
* USE WITH MF 86X0/87XX CHALLENGER MT 600C/D/E

RELEASED DATE	ECO #	REV.	DRAWING NO.
9/16/19	33988	D	054-7000-002
12/3/20	36523	E	054-7000-002

RAVEN ISOBUS CABLING

SECTION 2: IMPLEMENT COMPONENTS

GEN 1 ISOBUS CABLING - USE FOR SYSTEMS REQUIRING LESS THAN 25 AMP CURRENT DRAW

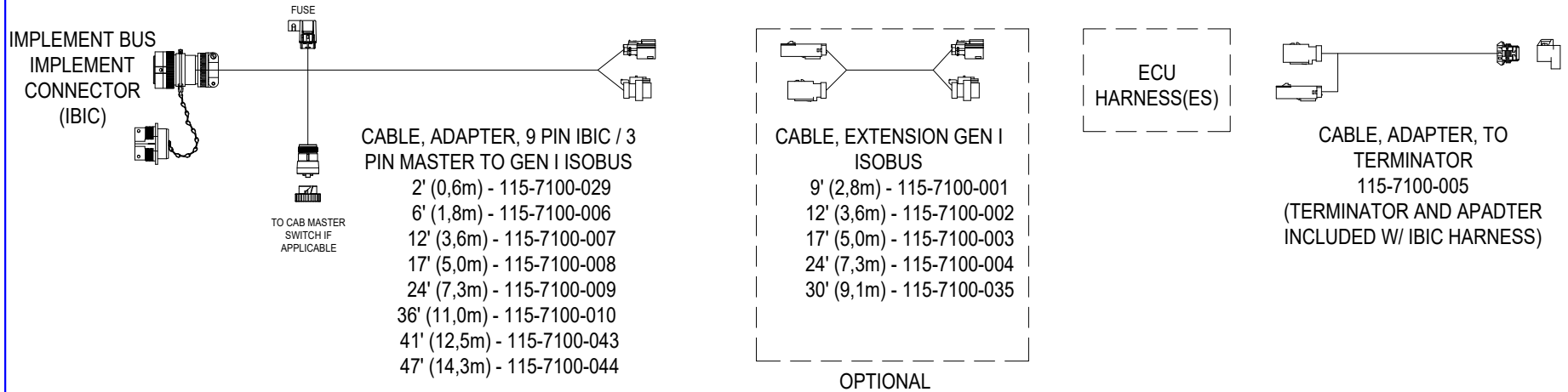

GEN 3 ISOBUS CABLING - USE FOR SYSTEMS REQUIRING MORE THAN 25 AMP CURRENT DRAW

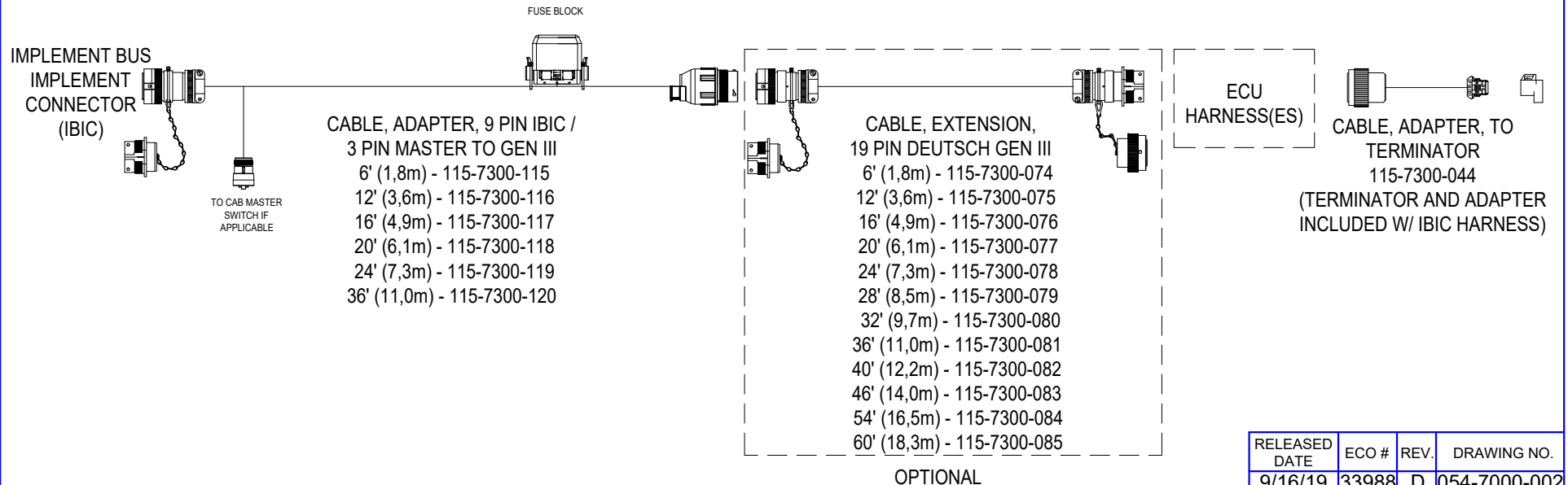

RELEASED DATE	ECO #	REV.	DRAWING NO.
9/16/19	33988	D	054-7000-002
12/3/20	36523	E	054-7000-002

SECTION 3: IMPLEMENT HARNESS ADAPTERS

GEN I ISOBUS

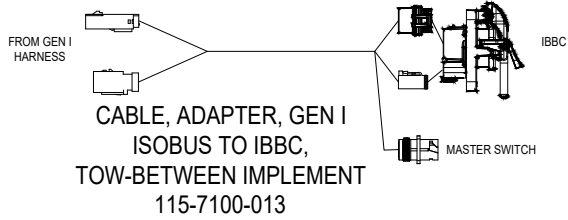

GEN III ISOBUS

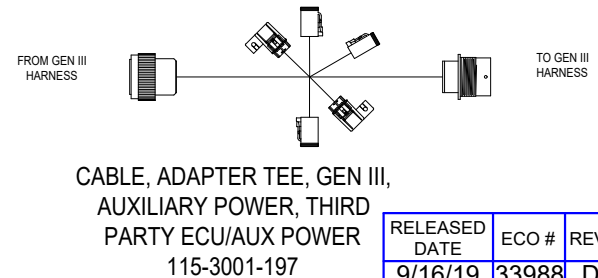
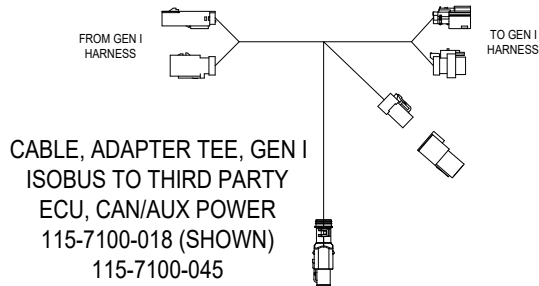
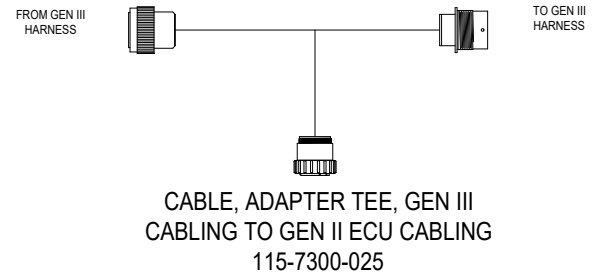
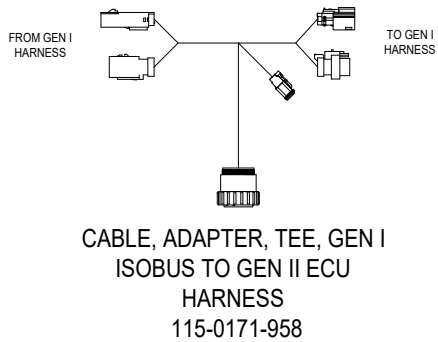
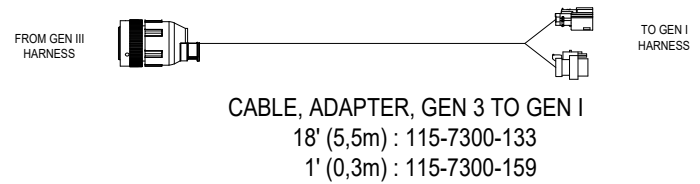
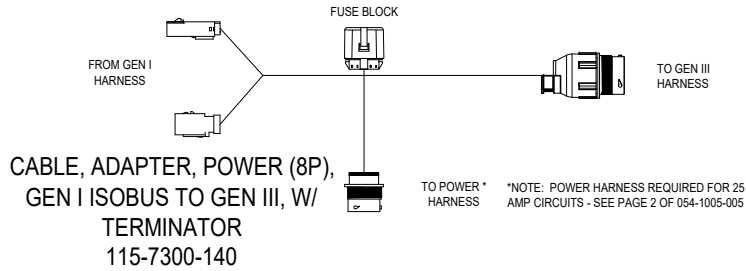
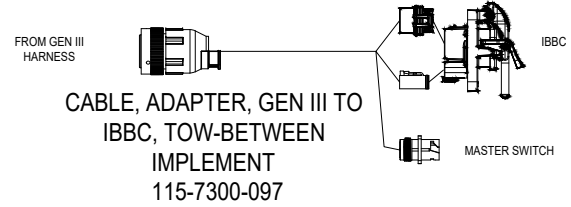

RELEASED DATE	ECO #	REV.	DRAWING NO.
9/16/19	33988	D	054-7000-002
12/3/20	36523	E	054-7000-002