

# ISOBUS Product Control Installation & Operation Manual

016-0171-362 Rev. F

08/16

E28148



## ***Disclaimer***

---

While every effort has been made to ensure the accuracy of this document, Raven Industries assumes no responsibility for omissions and errors. Nor is any liability assumed for damages resulting from the use of information contained herein.

Raven Industries shall not be responsible or liable for incidental or consequential damages or a loss of anticipated benefits or profits, work stoppage or loss, or impairment of data arising out of the use, or inability to use, this system or any of its components. Raven Industries shall not be held responsible for any modifications or repairs made outside our facilities, nor damages resulting from inadequate maintenance of this system.

As with all wireless and satellite signals, several factors may affect the availability and accuracy of wireless and satellite navigation and correction services (e.g. GPS, GNSS, SBAS, etc.). Therefore, Raven Industries cannot guarantee the accuracy, integrity, continuity, or availability of these services and cannot guarantee the ability to use Raven systems, or products used as components of systems, which rely upon the reception of these signals or availability of these services. Raven Industries accepts no responsibility for the use of any of these signals or services for other than the stated purpose.

---

Calibration Reference Sheet .....	3
Unit Definitions and Conversions .....	4
Unit of Measure Definitions .....	4
Unit of Measure Conversions .....	4
<b>Chapter 1    <i>Important Safety Information</i>.....</b>	<b>1</b>
Electrical Safety .....	1
Instructions for Wire Routing .....	1
Instructions for Hose Routing .....	2
<b>Chapter 2    <i>Introduction</i>.....</b>	<b>5</b>
Raven ISOBUS Product Control Node Kits .....	5
Updates .....	6
<b>Chapter 3    <i>Installation</i>.....</b>	<b>9</b>
Mount the Flow Meter .....	9
Mount the Control Valve .....	10
By-Pass Plumbing .....	10
Mount the Node .....	11
Install ISOBUS Product Control Cabling .....	12
Mount the Foot Switch .....	12
Implement Proximity Switch .....	12
<b>Chapter 4    <i>ISOBUS Product Control Node Calibration</i>.....</b>	<b>13</b>
Calibration Screen .....	14
Implement Calibration Tab .....	15
Applicator Type .....	15
Total Width Display .....	15
Section Setup .....	16
Product Control Calibration Tab .....	17
Control Type .....	18
Meter Cal or Spreader Constant .....	18
Valve Delay .....	19
Tank or Bin Capacity .....	19
Self Test Speed .....	19
Speed Cal .....	20
Pump RPM Cal .....	20
Valve Cal .....	20
Tiered Boom Settings .....	22
Spinner/Fan Control Setup .....	22
HP Pressure or HP Plus Control Setup .....	23
Pulse Width Modulation Valve Setup .....	25

Feature Settings .....	29
Alarms Setup Tab .....	32
Low Tank .....	32
Low Limit .....	32
Off Rate Percent .....	33
RPM Off Rate Percent (Granular Applications Only) .....	33
Dual Encoder Error Percent (Granular Applications Only) .....	33
Bin Level Sensor (Granular Applications Only) .....	33
Low Limit Pressure Setting .....	33
Low Supply Pressure Setting (AccuFlow HP Plus Applications Only) .....	33
Low Pressure Alarm (AccuFlow HP Applications Only) .....	33
Pump Fault Alarm (AccuFlow HP Plus Applications Only) .....	33
Information .....	34
Diagnostics .....	34

**Chapter 5    *ISOBUS Product Control Operation* ..... 35**

Product Control Home Screen .....	35
Quick Access Softkeys .....	36
Remote Master Status .....	37
Control Mode (Auto/Manual) .....	37
Application Speed .....	37
Pump RPM Cal (Spray Applicator) .....	38
Product Density (Granular Applications) .....	38
Target Pressure (NH3 Applications) .....	38
Pressure or Spinner/Fan RPM Display .....	39
Rates Area .....	40
Remaining Tank/Bin Volume .....	41
Volume/Weight Applied .....	41
Area Covered .....	42
Injection Pump Status Button .....	42
Section Status Display .....	43
On-Screen Manual Section Controls .....	43
Section Override .....	44
Tiered Boom Status Display .....	45
Tally Registers .....	45
Field Area and Volume .....	46
Total Area and Volume .....	46
Distance .....	46
Volume per Minute Display .....	46
Area per Hour Display .....	46

<b>Chapter 6</b>	<b><i>Troubleshooting</i></b> .....	<b>47</b>
<b>Appendix 7</b>	<b><i>System Diagrams</i></b> .....	<b>49</b>
<b>Appendix 8</b>	<b><i>Calculating the Calibration Values</i></b> .....	<b>59</b>
Section Widths	.....	59
Broadcast	.....	59
Band	.....	59
Rate Cal	.....	59
Tiered Boom Settings	.....	60
Valve Cal	.....	62
Valve Backlash Digit	.....	62
Valve Speed Digit	.....	62
Brake Point Digit	.....	62
Dead Band Digit	.....	62
Valve Cal 2	.....	63
Flow Cal (Dual Loop Control Mode)	.....	63
Sgain (Pressure System Gain - Dual Loop Control Mode)	.....	63
Spreader Constant	.....	64
Standard Rate display	.....	64
Metric Rate Display	.....	64
Verification of Spreader Constant	.....	64
Spinner RPM	.....	66
Valve Type	.....	66
RPM Meter Cal	.....	67
RPM Target	.....	67
<b>Appendix 2</b>	<b><i>Flow Meter Maintenance and Adjustment Procedure</i></b> .....	<b>v</b>
Flow Meter Maintenance	.....	v
Testing Flow Meter Cables	.....	v
Testing the Flow Meter/Encoder Cable	.....	v
Procedure to Recalibrate Flow Meter	.....	vi



## CALIBRATION REFERENCE SHEET

Record the settings and calibration values used when programming the field computer and keep this sheet for future reference or when contacting a service technician.

Circle the setting selected on the field computer for the following options:

UNITS	US (Acres)		SI (Hectares)		Turf (1000 Square Feet)
<b>CONTROL TYPE</b>	Liquid Sprayer	Gran 1 (Single belt bed)	Gran 2 (Split belt bed, single encoder)	Gran 3 (Split belt bed, dual encoders)	Spinner RPM Control
<b>VALVE TYPE</b>	Standard Valve	Fast Valve	Fast Close Valve	PWM Valve	PWM Close Valve

Write down the calculated calibration values in the spaces provided.

Boom Widths (Boom Cal)	Meter Cal	Rate Cal	Valve Cal	Volume in Tank/Bin
1.	1.	1.	1.	1.
2.	2.	2.	2.	2.
3.	3.	3.	3.	3.
4.	4.	4.	4.	4.
5.				
6.				
7.				
8.				
9.				
10.				
11.				
12.				
13.				
14.				
15.				
16.				

Density (Granular Only)	Spreader Constant (Granular Only)
1.	1.
2.	2.
3.	3.
4.	4.

## UNIT DEFINITIONS AND CONVERSIONS

### UNIT OF MEASURE DEFINITIONS

Abbreviation	Definition	Abbreviation	Definition
GPM	Gallons per Minute	dm	Decimeters
lit/min	Liters per Minute	m	Meter
dl/min	Deciliters per Minute	MPH	Miles per Hour
PSI	Pounds per Square Inch	km	Kilometers
kPa	Kilopascal	km/h	Kilometers per Hour
GPA	Gallons per Acre	US	Volume per Acre
lit/ha	Liters per Hectare	SI	Volume per Hectare
ml/ha	Milliliters per Hectare	TU	Volume per 1,000 Square Feet
GPK	Gallons per 1,000 Square Feet	[ ]	Metric Numbers
mm	Millimeters	lb/acre	Pounds per Acre
cm	Centimeters	kg/ha	Kilograms per Hectare

### UNIT OF MEASURE CONVERSIONS

To convert the METER CAL value into the selected unit of measure, divide the original number printed on the Flow Meter label by the desired conversion value.

Fluid Ounces Conversion Formula	Liters Conversion Formula	Pounds Conversion Formula
Original METER CAL Number 128	Original METER CAL Number 3.785	Original METER CAL Number Weight of One Gallon of Product



---

### Liquid

- 1 U.S. gallon = 128 fluid ounces
- 1 U.S. gallon = 3.785 liters
- 1 U.S. gallon = 0.83267 imperial gallons
- 1 U.S. gallon = 8.34 pounds (water)

### Length

- 1 millimeter (mm) = 0.039 inches
- 1 centimeter (cm) = 0.393 inches
- 1 meter (m) = 3.281 feet
- 1 kilometer (km) = 0.621 miles
- 1 inch = 25.4 mm or 2.54 cm
- 1 mile = 1.609 km

### Area

- 1 square meter = 10.764 square feet
- 1 hectare = 2.471 acres or 10,000 square meters
- 1 acre = 0.405 hectares or 43,560 square feet
- 1 square mile = 640 acres or 258.9 hectares

### Pressure

- 1 psi = 6.89 kPa
- 1 kPa = 0.145 psi

### Weight

- 1 Pound = 16 Ounces
- 1 Pound = 0.45 Kilograms



---

# CHAPTER

# 1

# IMPORTANT SAFETY INFORMATION

---

## NOTICE

Read this manual carefully before installing the Raven ISOBUS node.

- Follow all safety information presented within this manual.
- If you require assistance with any portion of the installation or service of your Raven equipment, contact a local Raven dealer for support.

When operating the machine after installing the Raven ISOBUS node, observe the following safety measures:

- Be alert and aware of surroundings.
- Do not operate any agricultural equipment while under the influence of alcohol or an illegal substance.
- Determine and remain a safe working distance from other individuals. The operator is responsible for disabling product control when a safe working distance has diminished.

Please review the operation and safety instructions included with your implement and/or controller.

## CAUTION

### ELECTRICAL SAFETY

Do not reverse power leads. Doing so could cause severe damage to the equipment. Always make sure that the power leads are connected to the correct polarity as marked. Ensure that the power cable is the last cable to be connected.

---

### INSTRUCTIONS FOR WIRE ROUTING

The word harness is used to mean all electrical leads and cables, bundled and unbundled. When installing harness, secure it at least every 30 cm (12in) to the frame. Follow existing harness as much as possible and use these guidelines:

Harness should not contact or be attached to:

- Lines and hoses with high vibration forces or pressure spikes
- Lines and hoses carrying hot fluids beyond harness component specifications

Avoid contact with any sharp edge or abrading surfaces such as, but not limited to:

- Sheared or flame cut edges
- Edges of machined surfaces
- Fastener threads or cap screw heads
- Ends of adjustable hose clamps
- Wire exiting conduit without protection, either ends or side of conduit
- Hose and tube fittings

Routing should not allow harnesses to:

- Hang below the unit
- Have the potential to become damaged due to exposure to the exterior environment. (i.e. tree limbs, debris, attachments)
- Be placed in areas of or in contact with machine components which develop temperatures higher than the temperature rating of harness components
- Wiring should be protected or shielded if it needs to route near hot temperatures beyond harness component specifications

Harnessing should not have sharp bends

Allow sufficient clearance from machine component operational zones such as:

- Drive shafts, universal joints and hitches (i.e. 3-point hitch)
- Pulleys, gears, sprockets
- Deflection and backlash of belts and chains
- Adjustment zones of adjustable brackets
- Changes of position in steering and suspension systems
- Moving linkages, cylinders, articulation joints, attachments
- Ground engaging components

For harness sections that move during machine operation:

- Allow sufficient length for free movement without interference to prevent: pulling, pinching, catching or rubbing, especially in articulation and pivot points
- Clamp harnesses securely to force controlled movement to occur in the desired harness section
- Avoid sharp twisting or flexing of harnesses in short distances
- Connectors and splices should not be located in harness sections that move

Protect harnesses from:

- Foreign objects such as rocks that may fall or be thrown by the unit
- Buildup of dirt, mud, snow, ice, submersion in water and oil
- Tree limbs, brush and debris
- Damage where service personnel or operators might step or use as a grab bar
- Damage when passing through metal structures
- High pressure wash

---

## INSTRUCTIONS FOR HOSE ROUTING

The word hoses is used to mean all flexible fluid carrying components. Follow existing hoses as much as possible and use these guidelines:

Hoses should not contact or be attached to:

- Components with high vibration forces
- Components carrying hot fluids beyond hoses component specifications

Avoid contact with any sharp edge or abrading surfaces such as, but not limited to:

- Sheared or flame cut edges
- Edges of machined surfaces
- Fastener threads or cap screw heads
- Ends of adjustable hose clamps

Routing should not allow hoses to:

- Hang below the unit
- Have the potential to become damaged due to exposure to the exterior environment. (i.e. tree limbs, debris, attachments)
- Be placed in areas of or in contact with machine components which develop temperatures higher than the temperature rating of hose components
- Hoses should be protected or shielded if it needs to route near hot temperatures beyond hose component specifications

Hoses should not have sharp bends

Allow sufficient clearance from machine component operational zones such as:

- Drive shafts, universal joints and hitches (i.e. 3-point hitch)
- Pulleys, gears, sprockets
- Deflection and backlash of belts and chains
- Adjustment zones of adjustable brackets
- Changes of position in steering and suspension systems
- Moving linkages, cylinders, articulation joints, attachments
- Ground engaging components

For hose sections that move during machine operation:

- Allow sufficient length for free movement without interference to prevent: pulling, pinching, catching or rubbing, especially in articulation and pivot points
- Clamp hoses securely to force controlled movement to occur in the desired hose section
- Avoid sharp twisting or flexing of hoses in short distances

Protect hoses from:

- Foreign objects such as rocks that may fall or be thrown by the unit
- Buildup of dirt, mud, snow, ice, submersion in water and oil
- Tree limbs, brush and debris
- Damage where service personnel or operators might step or use as a grab bar
- Damage when passing through metal structures
- High pressure wash



The Raven ISOBUS single product control node is designed to add liquid or granular speed compensated product control capabilities to ISOBUS virtual terminals. Adding the Raven ISOBUS product control node will allow a machine operator to monitor and control a Raven product control system directly from a virtual terminal (VT) display.

**NOTE:** Prior to using the product control feature with your VT display, the ISOBUS node must be calibrated for the product control system. See Chapter 5, ISOBUS Product Control Operation, for more information.

This manual assumes the required control hardware has already been installed on a specific implement and is properly connected and wired.

## RAVEN ISOBUS PRODUCT CONTROL NODE KITS

This section contains a list of kit contents which should have been supplied with the ISOBUS product control node. Before installing the Raven ISOBUS node, compare the items in the kit with the list. If you have questions regarding your kit, contact a local Raven dealer.

**NOTE:** A Raven ISOBUS hitch cable is required to connect the Raven ISOBUS product control node to the VT display and ISOBUS system. Depending upon the specific machine, this cable may be installed from the factory or must be ordered separately. Refer to Figure 1 on page 49 or contact a local Raven dealer for more information.

**TABLE 1. ISOBUS Single Product (Liquid/Granular) Node Kit (16-Pin Product Cable) (P/N 117-6100-001)**

**TABLE 2.**

Description	Part Number	Qty.
Terminator, Active CAN Powell	063-0172-964	1
Node, ISOBUS Single Product	063-0173-006	1
Switch, ISO Node Foot	063-0173-080	1
Cable, Main Node	115-0171-949	1
Cable, Cab Foot Switch, 8'	115-0171-865	1
Cable, ISO Powell Terminator Adapter	115-0171-963	1

**NOTE:** A 21' spinner control cable (P/N 115-0171-880) is required if the ISOBUS product control system will be utilized for spinner control applications.

**TABLE 3. ISOBUS Single Product (Liquid/Granular) Node Kit (37-Pin Product Cable) (P/N 117-6100-002)**

**TABLE 4.**

Description	Part Number	Qty.
Terminator, Active CAN Powell	063-0172-964	1
Node, ISOBUS Single Product	063-0173-006	1
Switch, ISO Node Foot	063-0173-080	1
Cable, Main Node	115-0171-945	1
Cable, Cab Foot Switch, 8'	115-0171-865	1
Cable, ISO Powell Terminator Adapter	115-0171-963	1

**NOTE:** A 21' spinner control cable (P/N 115-0171-880) is required if the ISOBUS product control system will be utilized for spinner control applications.

**TABLE 5. ISOBUS Single Product (Liquid/Granular) Node Kit (22-Pin Product Cable) (P/N 117-6100-003)**

**TABLE 6.**

Description	Part Number	Qty.
Terminator, Active CAN Powell	063-0172-964	1
Node, ISOBUS Single Product	063-0173-006	1
Switch, ISO Node Foot	063-0173-080	1
Cable, 37-pin to 22-pin Adapter	115-0171-864	1
Cable, Main Node	115-0171-945	1
Cable, Cab Foot Switch, 8'	115-0171-865	1
Cable, ISO Powell Terminator Adapter	115-0171-963	1

**NOTE:** A 21' spinner control cable (P/N 115-0171-880) is required if the ISOBUS product control system will be utilized for spinner control applications.

## UPDATES

Updates for Raven manuals as well as software updates for Raven consoles are available at the Applied Technology Division web site:

[www.ravenhelp.com](http://www.ravenhelp.com)



Sign up for e-mail alerts to receive notifications when updates for your Raven products are available on the Raven web site.

At Raven Industries, we strive to make your experience with our products as rewarding as possible. One way to improve this experience is to provide us with feedback on this manual.

Your feedback will help shape the future of our product documentation and the overall service we provide. We appreciate the opportunity to see ourselves as our customers see us and are eager to gather ideas on how we have been helping or how we can do better.

To serve you best, please send an email with the following information to

[techwriting@ravenind.com](mailto:techwriting@ravenind.com)

- ISOBUS Product Control Installation & Operation Manual
- Manual No. 016-0171-362 Rev. F
- Any comments or feedback (include chapter or page numbers if applicable).
- Let us know how long have you been using this or other Raven products.

We will not share your email or any information you provide with anyone else. Your feedback is valued and extremely important to us.

Thank you for your time.

2



# CHAPTER 3 INSTALLATION

## 3

### MOUNT THE FLOW METER

1. Mount the flow meter in the area of the boom valves as shown in Figure 1. All flow through the flow meter must go to the booms, (i.e. no return line to tank or pump after flow meter).
2. Mount the flow meter horizontal to the ground.
3. For best results, allow a minimum of 7-1/2" [20 cm] of straight hose on inlet of flow meter. Bend radius of hose on outlet of flow meter should be gradual.
4. Flow must be in direction of arrow on flow meter.

FIGURE 1. Flow Control System

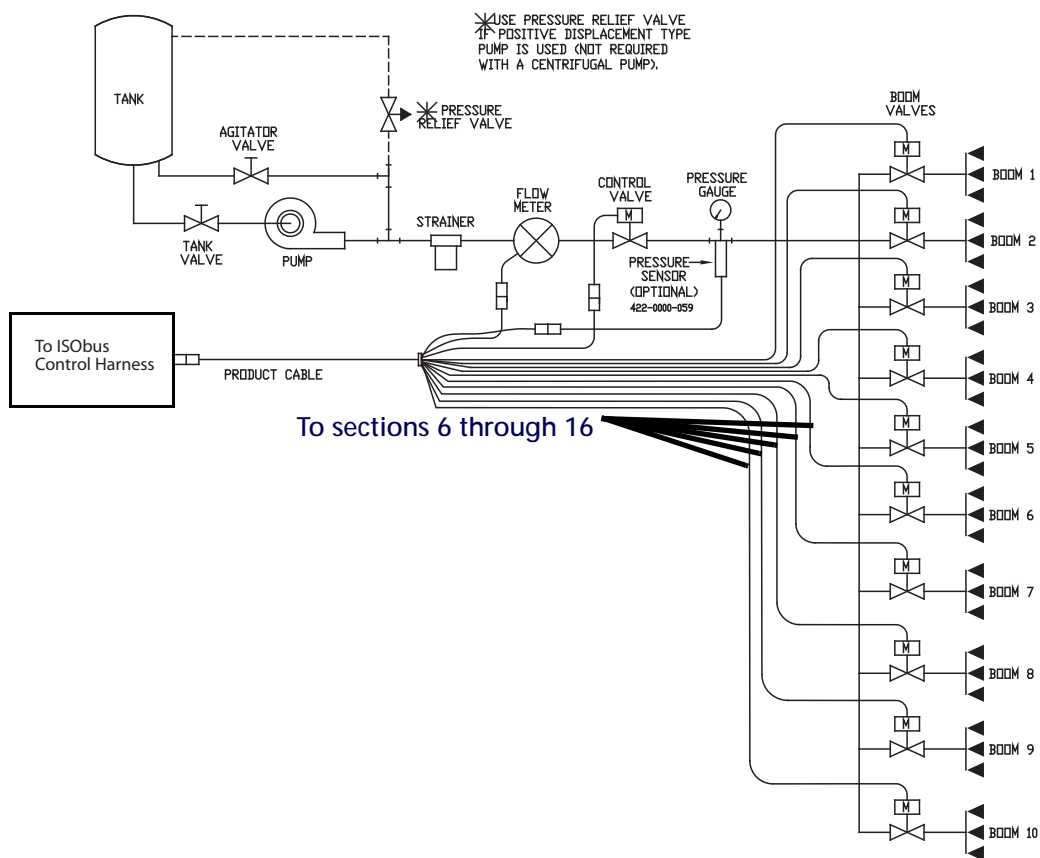

## MOUNT THE CONTROL VALVE

1. Mount the motorized control valve in the main hose line between the flow meter and the booms, with the motor housing in the upright position. Refer to Figure 1 on page 9.
2. Connect the flow control cable connectors to the boom valves, flow meter, and motorized control valve. The table below tells white wire color(s) connect to each valve:

Wire Colors	Labeled	Connect to Valve
Black or Gray	Valve #1	1
Brown	Valve #2	2
Blue	Valve #3	3
Black with white stripe	Valve #4	4
Brown with a white stripe	Valve #5	5
Blue with a white stripe	Valve #6	6
White with a black stripe	Valve #7	7
White with a brown stripe	Valve #8	8
White with a blue stripe	Valve #9	9
Pink or Violet	Valve #10	10
Yellow with a white stripe or Gray	Valve #11	11
Green with white stripe or Brown	Valve #12	12
Red with white stripe or Blue	Valve #13	13
White with yellow stripe or Black with white stripe	Valve #14	14
White with a green stripe or Brown with a white stripe	Valve #15	15
White with a red stripe or Blue with a white stripe	Valve #16	16

## BY-PASS PLUMBING

For flow less than 3 GPM [11 lit/min] the motorized control valve must be mounted in a by-pass line.

FIGURE 2. By-Pass Plumbing Diagram

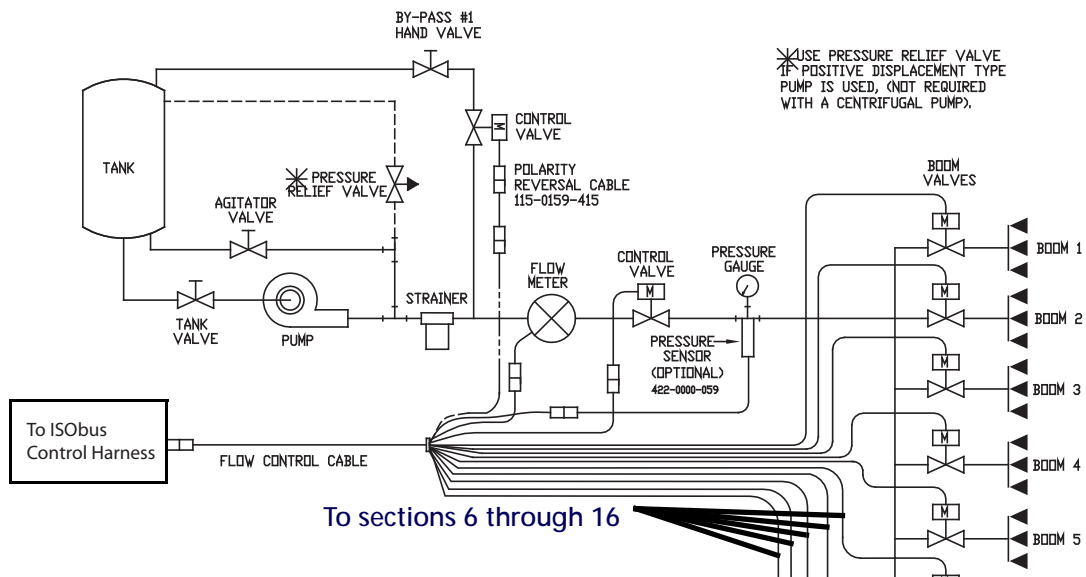

## MOUNT THE NODE





NOTICE

Be sure to read all safety instructions and follow all installation procedures to ensure proper installation of the ISOBUS system.

The Raven ISOBUS node is mounted to the specific implement with which the product control features are to be used.

When selecting a location to mount the node, consider the following points:

- The node mounting location must not create tripping hazards and allow cable routing to avoid crimping or damaging the cables or the node connections.
- The node should not be directly exposed to moisture or chemicals during normal operation and should be mounted so that the node connectors face down (toward the ground).
- For wiring connections made outside the cab or protected enclosure, apply dielectric silicone grease to the pins (P/N 222-0000-006) on the male end of the connectors. Application of the grease will help prevent corrosion to the pins and wires.
- Mount the node to a flat surface in a location where it will not be jarred during normal equipment operation.

## INSTALLATION BEST PRACTICES

The information below illustrates proper methods for wiring a CANBUS system. The diagrams provided later in this chapter are a good reference for both OEM and aftermarket installations. The main points are summarized below.

1. Always use sealed connectors with dielectric grease. Unsealed, crimped connections (i.e. butt connectors) should be avoided.

2. Isolate the power and ground sources for the console and node logic, or node processor, power on separate leads to the vehicle battery or another source of clean power.
3. Use dedicated bus bars to connect the console and all nodes to the same source for both power and ground.
4. Provide relays to switch power on and off to avoid draining the battery. Raven recommends connecting CAN nodes to a clean source of controlled power.

Following these recommendations will result in the most robust system possible while greatly reducing CAN communication problems.

---

### INSTALL ISOBUS PRODUCT CONTROL CABLING

1. Connect the large, rectangular connectors of the ISO product controller cable to the ISO product node.
2. Connect the round, female connector of the product controller cable to the product flow control cabling on the implement.
3. Connect the round, male connector of the product controller cable to the ISOBUS hitch cable (ordered separately).

**NOTE:** A ISO implement extension tee cable is necessary to connect the VT terminal with additional hardware for Raven ISO features. Contact a local Raven dealer for more information.

4. Connect the active terminator adapter cable to the remaining round connector on the ISOBUS hitch cable and install the Powell terminator (P/N 063-0172-964).
5. Connect the round, metal connector to the IBBC harness on the tractor. Refer to Appendix 7, System Diagrams.

---

### MOUNT THE FOOT SWITCH

1. Mount the ISO node foot switch (P/N 063-0173-080) within the cab or drivers compartment of the vehicle within easy reach of the operator.
2. Connect the foot switch extension cable (P/N 115-0171-865) to the foot switch and route to the vehicle hitch.
3. Connect the 4-pin deutsch connector on the foot switch extension cable to the ISOBUS hitch cable on the implement.

---

### IMPLEMENT PROXIMITY SWITCH

**NOTE:** Refer to the proximity switch installation sheet for instructions on mounting the proximity switch.

1. Locate the connector labeled 'Prox. Switch' on the CAN AccuFlow HP or "AccuFlow HP Plus" cable.
2. Connect the cable from the implement proximity switch body to the 'Prox. Switch' connector.

---

# CHAPTER

# 4

# ISOBUS PRODUCT CONTROL NODE CALIBRATION

---

Before the Raven ISOBUS product control node may be used to control product application, the node must be properly calibrated for the type of application and the specific implement being used. The following calibration values are required to accurately control product application:

- Total width of implement
- Number of sections and section widths
- Control type
- Meter cal or spreader constant and product density
- Valve type and cal
- Rate cal

**NOTE:** Refer to the VT display operation manual for other necessary setup or calibration required before operating the Raven ISOBUS product control node.

## TO ACCESS THE SETTINGS DISPLAYS:

1. Start-up the VT display. Allow the display to power up and initiate the ISOBUS system.

**NOTE:** If properly connected and powered, the Raven ISOBUS product control node will be automatically detected by the VT display. If the product control node is not detected by your display terminal, troubleshoot the node and restart the system. If the node is still not found, refer to Chapter 6, Troubleshooting, and use the diagnostic LED's on the node to diagnose the problem.

2. Once the product control node is detected, the product control icon will be displayed in the VT display menu.



Select the icon to access the main product application screen.

3. Select the tools icon at the right side of the screen to display the calibration screen.

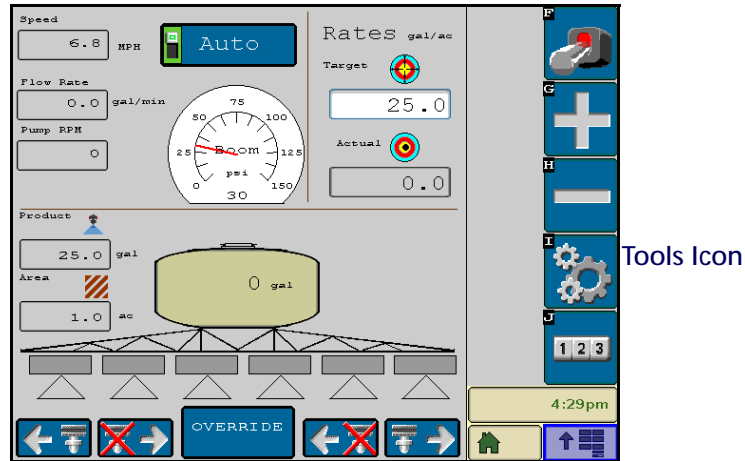

**NOTE:** For a description of the information displayed on the product control home screen, see the Product Control Home Screen section on page 37.

## CALIBRATION SCREEN

The various settings and calibration values are displayed in three categories which can be viewed by selecting the icons at the top of the screen.

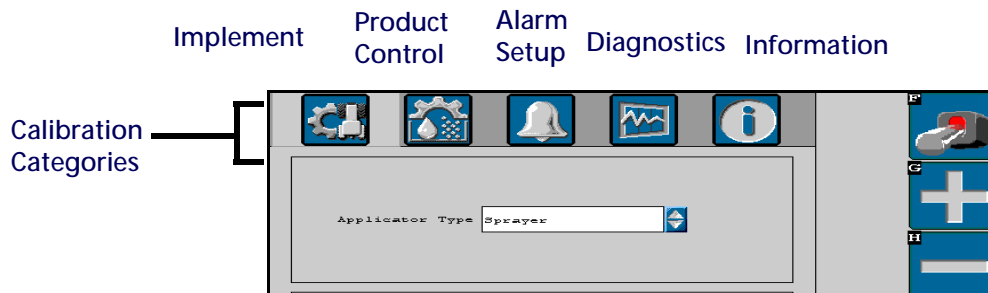

- Implement Calibration - Access the vehicle or implement settings to adjust the total width, number of sections, and the section width.
- Product Control Settings - Access the product control settings to adjust settings such as the meter or valve calcs or adjust the rate +/- or product control home screen display.
- Alarms Setup - Access the alarms setup screen to modify the conditions of which the machine operator should be aware during product control applications.
- Information - Select the information icon to view the ISOBUS product control node hardware and software version numbers.



## IMPLEMENT CALIBRATION TAB

The following settings may be viewed or modified when the implement category is selected:

- Applicator type
- Total width
- Number of sections
- Section widths
- Switch mapping (optional)

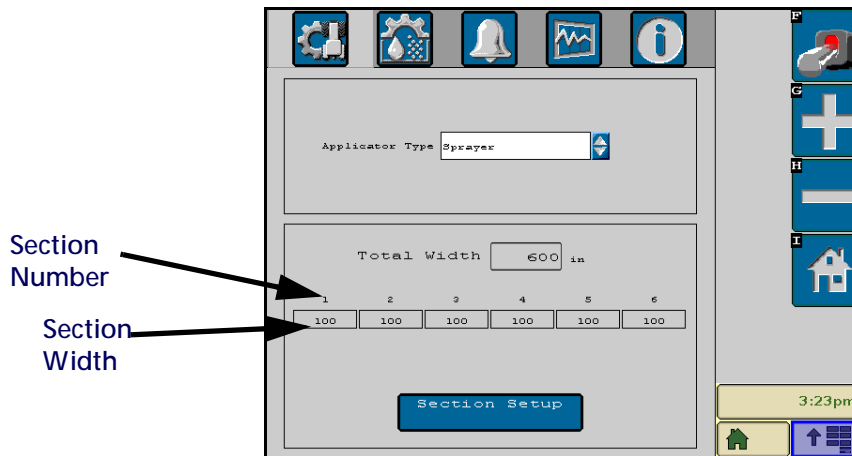

## APPLICATOR TYPE

Select the “Applicator Type” drop down menu to change the type of applicator being used with the ISOBUS product control system. Select between the following configurations:

- Sprayer - For liquid application systems, select the sprayer option.
- Spreader - Spinner - Select the spinner option for granular applicators using a spinner.
- Spreader - Air - Select the air option for air driven application systems.
- NH3 Applicator - Select the NH3 applicator option for an anhydrous tool bar. When this is opened check boxes for HP Boost or HP Plus will be available. Choose one of the control modes based on the installed NH3 configuration.

**NOTE:** When operating with the Raven AccuFlow HP system, additional settings will be required to control the boost pump. Refer to the HP Pressure or HP Plus Control Setup section on page 23 and refer to the AccuFlow, AccuFlow HP, and AccuFlow HP Plus Installation and Operation Manual for details on boost pump settings.

## TOTAL WIDTH DISPLAY

The total width value displays the sum of the currently programmed section widths. Select the “Section Setup” button to edit section widths and change the total width for a specific implement.

## SECTION SETUP

Select the “Section Setup” button to reconfigure the number and width of programmed sections.

### NUMBER OF SECTIONS

The first screen displayed in the section setup displays the current number of sections. Select the value displayed in the box and enter the number of sections configured on the implement or select Next >> to proceed.



**NOTE:** Contact a local Raven dealer for appropriate cabling for specific applications and boom configurations.

### SECTION WIDTHS

The next screen in the section setup displays the current section widths for each section. Select the section width value to enter the section width.

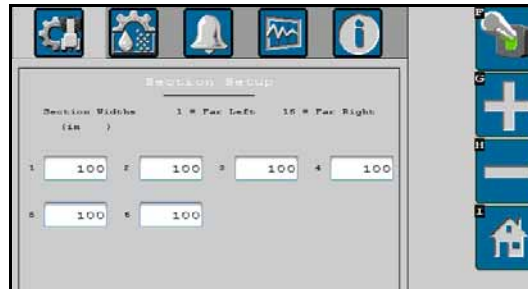

**NOTE:** Section measurements should be programmed into the VT display using the same units (e.g. inches, centimeters) selected in the options or settings on the VT display. Refer to the operation manual for the specific VT display to configure the display units.

See Section Widths section on page 59, for detailed calculation of the section width values.

When finished programming section widths, select the “OK” button to return to the Implement settings display.

**NOTE:** If the system contains an optional Raven ISO switch box, press Next >> to proceed.

SWITCH MAPPING

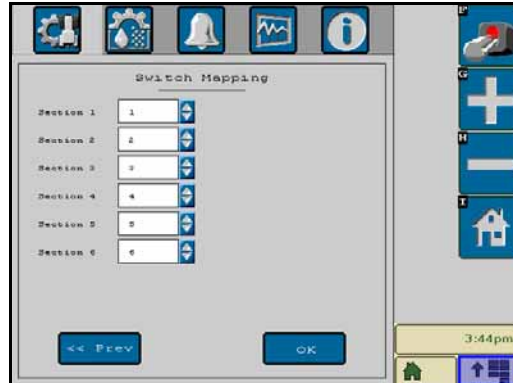

**NOTE:** Switch mapping is only available if an optional Raven ISO Switch Box is detected on the ISOBUS.

The next screen in the section setup allows for a customized section to switch mapping setup. This allows the operator to quickly control multiple sections using a single switch. This feature also allows the operator to control an implement that has more sections than switches available on the switch box. To assign a switch to a section, select the number of the switch in the menu for a section. Repeat the process for each remaining section.

PRODUCT CONTROL CALIBRATION TAB

The following settings may be viewed or modified when the implement category is selected:

- Control Type
- Meter Cal or Spreader Constant
- Valve Cal
- Valve Delay
- Tank Capacity
- Pressure Cal (Liquid)
- Spinner/Fan Control Setup or HP (AccuFlow HP) Pressure Control Setup or HP+ Control Setup
- Self Test Speed
- Pump RPM Cal
- Feature Settings
- Tiered Boom Settings

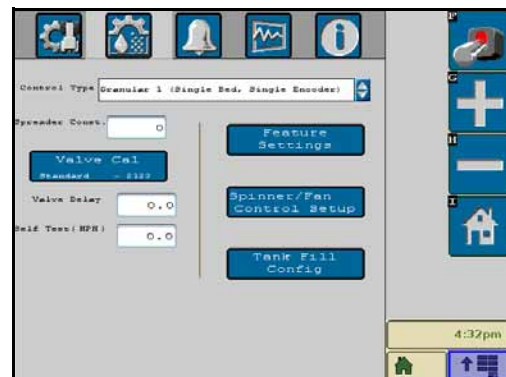
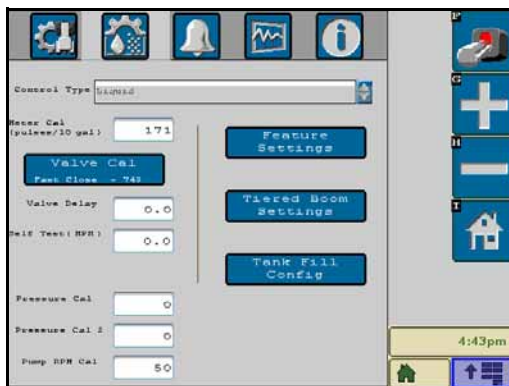

The following product control home screen features and settings may be adjusted on the Feature Settings screen:

- Rate Bump (+/-)
- Display Smoothing
- Zero Speed Shutoff
- Pressure Display
- Implement Switch (NH3 Applicator only)
- PWM Smart Control
- Dual Loop Control
- Standby Pressure
- High Side Drive
- Rate 1/Rate 2

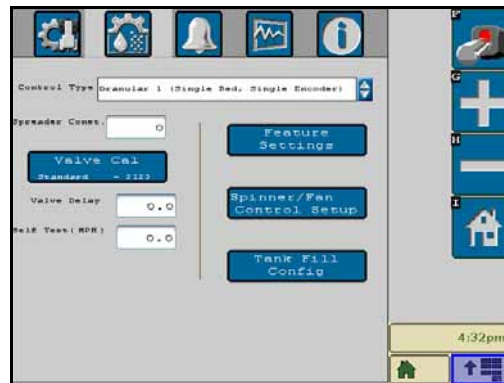

**NOTE:** For more information on enabling and using the main screen features, see the Feature Settings section on page 29.

## CONTROL TYPE

Select the “Control Type” drop down menu to change the type of product to be controlled by the ISOBUS node. Select between the following types of product control types:

- Liquid
- Granular 1 (Single Bed, Single Encoder, with or without Spinner)
- Granular 2 (Dual Bed, Single Encoder, with or without Spinner)
- Granular 3 (Dual Bed, Dual Encoder, with or without Spinner)

**NOTE:** When the applicator type is set to ‘Sprayer’ or ‘NH3 Applicator,’ the Control Type option is locked on Liquid.

## METER CAL OR SPREADER CONSTANT

The flow meter calibration, or meter cal, value can be found on the tag attached to the flow meter.

**NOTE:** It is recommended to copy the information from the tag for future reference as tags may fade or be lost during operation.

If operating in a granular application mode, the spreader constant replaces the meter cal value. To maintain system accuracy, re-calibrate the spreader constant anytime the gate height of the machine is adjusted. Refer to the Spreader Constant section on page 64 for assistance calculating the value of the spreader constant.

**NOTE:** When controlling an anhydrous ammonia (NH<sub>3</sub>) applicator with the Raven ISOBUS product control node, be sure to enter the pounds [kilograms] of (N) meter cal value.

## VALVE DELAY

Use the valve delay option to include a delay in seconds between turning on the control valve (turning on sections) and when the product control nodes begin to control the flow rate. This feature is useful when starting product application at lower speeds than normal application speed such as coming out of headland areas.

**NOTE:** A value of zero must be entered when using a close-type valve, such as a fast close or PWM close valve.

### FOR EXAMPLE:

The control valve remains at the position when the master switch is toggled off when coming to the end of a swath and entering a headland area.

Without a valve delay set, as the vehicle leaves the headland area and the master switch is toggled back on, the node and control valve will immediately adjust the rate of product application. If the vehicle speed is slower than normal application speeds, the control valve will begin closing to adjust for the slower speed until the normal application speed is reached.

Using a valve delay value of 2 seconds, when the master switch is toggled back, the node and control valve will wait two seconds before adjusting the for vehicle speed. This allows the machine to reach normal application speed and helps maintain the application pattern upon re-entry from the headland area.

## TANK OR BIN CAPACITY

The tank or bin indicator on the product control home screen displays a tally of product remaining based upon the capacity value. The tank or bin volume is the volume of product currently in the tank or bin, not the capacity of the tank or bin. Set this value to the normal volume of product in a full tank or bin.

## SELF TEST SPEED

Enter a value approximately equal to normal application speeds to allow the system to control product application functions while the vehicle remains stationary. The test speed is useful for checking or troubleshooting the product control system.

**NOTE:** This is only used internally on the Product Controller. This is not sent to any other ECUs.

The currently set self test speed is displayed in this area. Select this value to enter a test speed.

The test speed will clear if the field computer receives a pulse from the actual speed sensor. To keep the test speed from disengaging, disconnect the speed sensor from the system.

## SPEED CAL

A speed cal input is enabled if the controller is being used in conjunction with a switchbox that supports speed input calibration. The speed cal value is used to adjust in the incoming signal from the speed source. To set the speed cal value, start with 600 as an initial value. On the totals screen, reset the distance value to 0. Drive one mile while slowly decelerating and accelerating. If the distance reading is not between 5,260 feet and 5,300 feet (995 meters and 1,005 meters), use the following calculation to determine the speed cal value:

$$\text{Current Speed Cal} \times \text{Known Distance Traveled} / \text{Distance Displayed on Total Screens} = \text{Adjusted Speed Cal} \quad (\text{EQ 1})$$

## PUMP RPM CAL

The pump RPM cal is used to calibrate the pump on the machine. Enter the number of pulses sensed per revolution of the fan or pump. These values are used for monitoring purposes only. There is no control based on these values or the monitored RPM of the pump. When a non-zero value is entered for pump RPM cal, a pump RPM will display on the home screen.

## VALVE CAL

Select the “Valve Cal” button on the Product Control Calibration screen to display the valve calibration screen for the product control valve or the hydraulic control valve controlling the speed of a belt or auger system.

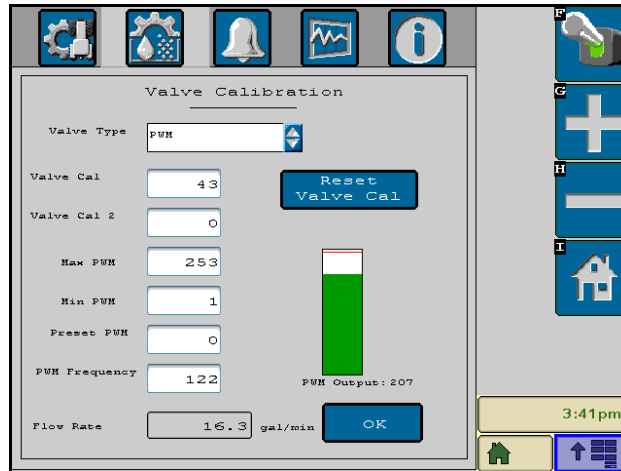

**NOTE:** To accept the currently displayed settings, or once settings have been adjusted properly, select the “OK” button in the lower right corner of the display to return to the Product Calibration display.

## VALVE TYPE

Select the type of control valve used to control the product application. Choose between a standard, fast, fast close, PWM, or PWM close valve for this setting.

**NOTE:** If a pulse width modulation (PWM) type valve is selected, additional settings will be displayed on the Valve Calibration screen. See the Pulse Width Modulation Valve Setup section on page 25 for a description of these settings.

## VALVE CAL

**NOTE:** If the dual loop control feature is enabled, the valve cal value will be replaced by the flow cal value.

The valve cal value sets the responsive characteristics of the control valve and is required for product control. The recommended value is automatically entered when the valve type is selected. For more information about adjusting the valve cal, see the Valve Cal section on page 62.

### VALVE CAL 2

**NOTE:** If the dual loop control feature is enabled, the valve cal 2 value will be replaced by the Sgain value.

The valve cal 2 value can fine tune control valve response and help control application rate oscillations when the console is programmed in PWM mode.

When a fast close valve is selected, the valve cal 2 value is utilized to enable a high resolution rate control for lowering application rates. Enter a non-zero value for the time, in milliseconds, which the valve will be fully opened before switching into high resolution control. For example, a value of 200 will give the valve a 200 millisecond "burst" at a fully 12 V to open the fast valve from the closed position before resuming product rate control. A zero value will disable this feature.

### RESET VALVE CAL BUTTON

Select "Reset Valve Cal" button to reset the recommended value for the selected valve type.

### VALVE ADVANCE

This feature allows the operator to set the amount of time (in seconds) which the control valve will open after boom sections are toggled off while in automatic rate control mode. A value of 1-9 means an advance of 1-9 seconds respectively. A value of 0 means no advance. This setting may be used in conjunction with the valve delay for low rate applications to build up pressure when the master switch is toggled on. For best results, approach the headlands at consistent speeds while turning boom sections off.

**NOTE:** The valve advance value is only accessible if a standard, fast or fast close valve is selected and if the assigned product control node has software version 2.2.05 or higher.

### FLOW RATE DISPLAY

The flow rate display on the Valve Calibration screen displays the current product flow rate as a reference.



## TIERED BOOM SETTINGS

A tiered boom configuration has two or more booms stacked - one directly in front of the other - and may or may not have different sets of nozzles capable of applying different rates.

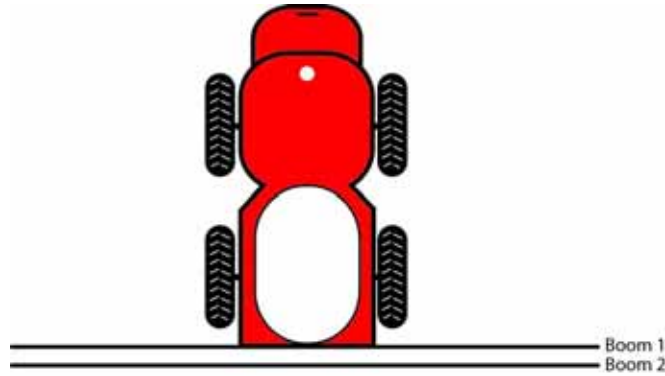

**NOTE:** Specialized plumbing, cabling, and a relay box are required to utilize a tiered boom configuration. Generally, sprayers are not set up for this feature from the factory.

Refer to Tiered Boom Settings section on page 60 for more information on calculating the tiered boom settings.

## SPINNER/FAN CONTROL SETUP

**NOTE:** A meter cal value is required for either spinner speed control or monitoring spinner speed during field operations. Refer to the following procedure to enter a meter cal on the Spinner/Fan Control Setup screen for either spinner control or monitoring operations.

In a granular control system, the RPM of a fan or spinner may be monitored or controlled via the ISOBUS product control system. To access the Spinner/Fan Control Setup screen from the Raven ISOBUS main screen:

1. Select the Tools Menu icon from the quick access softkeys.
2. Select the Product Control Calibration icon at the top of the screen.
3. Select the 'Spinner/Fan Control Setup' button. The Spinner/Fan Control Setup screen will be displayed.

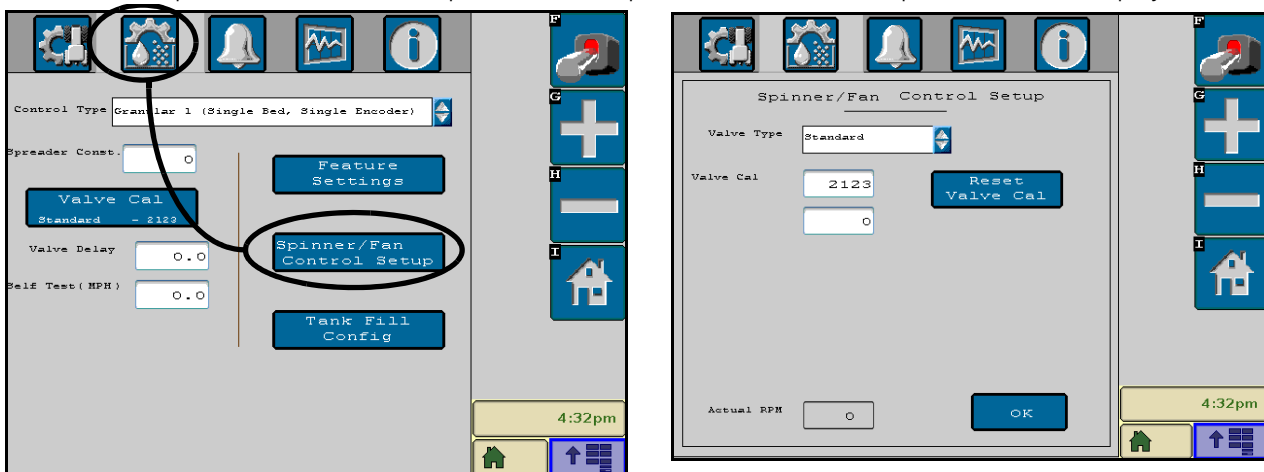



## VALVE TYPE

Select the type of control valve used to control the product application. Choose between a standard, fast, fast close, PWM, or PWM close valve for this setting.

**NOTE:** If a pulse width modulation (PWM) type valve is selected, additional settings will be displayed on the Valve Calibration screen. See the Pulse Width Modulation Valve Setup section on page 25 for a description of these settings.

## VALVE CAL

The valve cal value sets the responsive characteristics of the control valve and is required for product control. The recommended value is automatically entered when the valve type is selected. For more information about adjusting the valve cal, see the Valve Cal section on page 62.

## METER CAL

The meter cal value displayed on the Spinner/Fan Control Setup screen calibrates the fan or spinner sensor. Enter the number of pulses detected by the sensor per 10 revolutions of the fan or spinner.

Calculate the fan or spinner meter cal value by counting the number of bolt heads which the proximity sensor will detect per revolution of the fan or spinner and multiply that number by ten.

## RESET VALVE CAL BUTTON



Select "Reset Valve Cal" button to reset the recommended value for the selected valve type.

## ACTUAL RPM DISPLAY

The actual RPM display on the Spinner/Fan Control Setup screen displays the current RPM of the fan or spinner as a reference.

## HP PRESSURE OR HP PLUS CONTROL SETUP

When interfacing with the Raven AccuFlow HP system for anhydrous ammonia applications, the ISOBUS product control system is capable of controlling the boost pump pressure for higher speed or cold weather applications. When interfacing with the Raven AccuFlow HP Plus system for HN3 applications, the ISOBUS product control system is capable of engaging a boost pump in order to control higher application rates. Two pressure transducers are required to run the system in the fully operational HP Plus mode to ensure proper pump operation.

	<div style="background-color: red; color: white; padding: 5px; text-align: center;">  <b>DANGER</b> </div> <p>Anhydrous ammonia can cause severe burning, blindness or death. Carefully read and follow all safety instructions and warnings provided in the AccuFlow, AccuFlow HP, and AccuFlow HP Plus Installation and Operation Manual. Do not allow anyone to operate the AccuFlow system without proper instruction and training.</p>
---	--

To access the HP Pressure or HP Plus Control Setup screen from the Raven ISOBUS main screen:

1. Select the tools menu icon along the right side of the screen.
2. Select the Product Control Calibration icon at the top of the screen.

3. Select the HP Pressure or HP Plus Pump Control Setup button. The HP Pressure or HP Plus Pump Control Setup screen will be displayed.

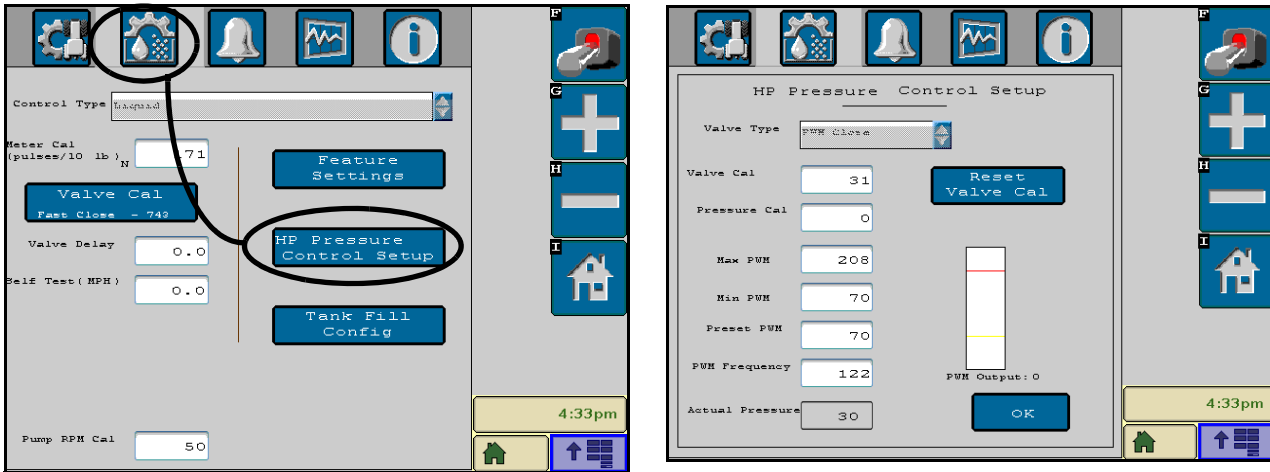

### VALVE TYPE

The Valve Type option on the HP Pressure or HP Plus Pump Control Setup screen is locked to PWM close when controlling an NH3 Applicator.

**NOTE:** Refer to the Pulse Width Modulation Valve Setup section on page 25 for details on setting the min and max PWM, preset PWM and PWM frequency values.

### VALVE CAL

The valve cal value sets the responsive characteristics of the control valve and is required for product control. The recommended value is automatically entered when the valve type is selected. For more information about adjusting the valve cal, see the Valve Cal section on page 62.

**NOTE:** Review the AccuFlow and AccuFlow HP and HP Plus Installation and Operation Manual for details on initial settings and calibration information for boost pump control.

### RESET VALVE CAL BUTTON

Select “Reset Valve Cal” button to reset the recommended value for the selected valve type.

### MAX AND MIN PWM, PRESET PWM AND PWM FREQUENCY SETTINGS

Review the AccuFlow, AccuFlow HP, and AccuFlow HP Plus Installation and Operation Manual for details on initial settings and calibration information for programming boost pump control.

### PRESSURE CAL

A non-zero pressure cal value is required when controlling an AccuFlow HP or AccuFlow HP Plus system to ensure that the ISOBUS product control node correctly engages the boost pump during anhydrous ammonia applications. Two pressure transducers are required in HP Plus operation to engage the boost pump for higher application rates.

To properly set the pressure cal:

1. Charge the AccuFlow HP system (review the AccuFlow, AccuFlow HP, and AccuFlow HP Plus Installation and Operation Manual and follow all safety instructions and warnings when charging the AccuFlow HP system).
2. Allow the pressure to stabilize and, with the control valve and any section valves in the closed position, read the gauge pressure on the gauge assembly.
3. For an AccuFlow HP system, navigate to the Pressure Control Setup screen (refer to the instructions provided under the HP Pressure or HP Plus Control Setup section on page 23) and enter the gauge reading.
4. For an AccuFlow HP Plus system, enter the pressure cal value for the outlet pressure transducer as "Pressure Cal" on the product control calibration screen. Enter the pressure cal value for the inlet pressure transducer as "Pressure Cal 2" on the product control calibration screen.

**NOTE:** Do not enter the rate cal or target pressure as the pressure cal value. The pressure cal value must only be used to calibrate the pressure transducer connected to the Raven ISOBUS product control system. Refer to Target Pressure (NH3 Applications) section on page 40 to set the target pressure for the AccuFlow HP boost pump.

### ACTUAL PRESSURE DISPLAY

Once the AccuFlow pressure transducer is properly calibrated, the current pressure of the anhydrous ammonia product is displayed at the bottom of the HP Pressure Control Setup screen.

### PWM OUTPUT DISPLAY

The PWM output display represents the currently programmed min and max PWM values as well as the current PWM output of the valve.

### PULSE WIDTH MODULATION VALVE SETUP

If a pulse width modulation (PWM) type valve is selected as the valve type on either the Valve Calibration or Spinner/Fan Control Setup screens, the following additional settings will be displayed.

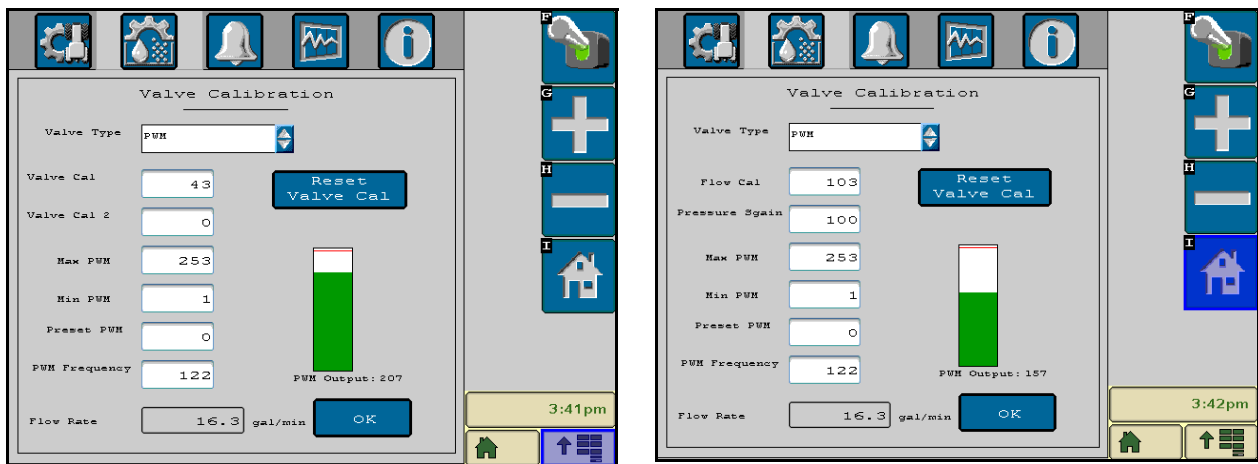

### FLOW CAL (DUAL LOOP CONTROL MODE ONLY)

The flow cal value may be used when controlling a liquid application system using a PWM control valve. This value sets how the system responds to rate control inputs while product is flowing through the flow meter. A value between 11 and 999 may be entered for the flow cal value. The default value for the flow cal is 103.

Refer to the Flow Cal (Dual Loop Control Mode) section on page 63 for information on the components of the flow cal setting or on refining the flow cal value.

**NOTE:** It is recommended to set the Sgain value prior to making any adjustments to the flow cal value.

When adjusting the flow cal value, it is not recommended to adjust the last digit (i.e. '3' in the default value). Review the Flow Cal (Dual Loop Control Mode) section on page 63 for more information.

### SGAIN (PRESSURE SYSTEM GAIN - DUAL LOOP CONTROL MODE ONLY)

The Sgain value may be used when controlling a liquid application system using a PWM control valve. Use this value to adjust how aggressively the application system responds to pressure changes in the application system. The default setting for the Sgain value is 100. To adjust the system aggressiveness, enter a value between 1 and 999 as necessary.

**NOTE:** It is recommended to increase or decrease the current value in increments of 10 or less when making adjustments to the Sgain setting. If the new value does not produce significant or notable changes in the system response, increments of 20 may be used.

For example, increase the Sgain value if the observed product pressure increases too slowly or if the system takes a long time to reach a set standby pressure or rate input change. If the system is consistently over shooting a set standby pressure or oscillating around a target rate, decrease the Sgain value until the system stabilizes.

## STANDBY PRESSURE SGAIN

The standby pressure feature may be enabled in either the standard or dual loop control modes. When enabled in the standard control mode, the Sgain value is not displayed on the Valve Calibration screen, but is still used to set the response of the system to the application system pressures.

**NOTE:** Refer to the Feature Settings section on page 29 for information about enabling the standby pressure feature on the Feature Settings screen.

To access and set the Sgain value while operating in the standard control mode:

1. From the Home screen, select the Tools Menu icon.
2. Select the Product Control icon from the System menu.

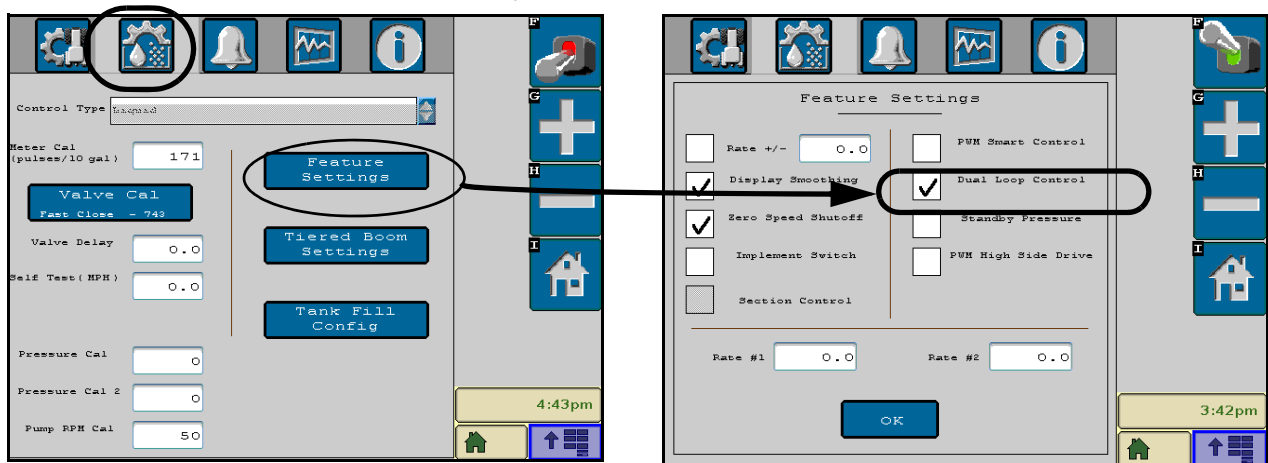

3. Touch the Feature Settings button.
4. On the Feature Settings screen, touch the dual loop control option to enable the feature and select the Accept icon to return to the Product Control Configuration screen.

**NOTE:** Refer to the Feature Settings section on page 29 for additional information about the settings and features available on this screen.

5. Select the Valve button on the Product Control Configuration screen and touch the Sgain button.
6. Use the on-screen keypad to enter the desired Sgain value and touch the Accept icon to save the new value.
  - a. Increase the Sgain value if the product pressure takes too long or cannot reach the set standby pressure.
  - b. Decrease the Sgain value if the product pressure overshoots or oscillates around the set standby pressure.
7. Return to the Feature Settings screen and disable the dual loop control feature before resuming product application in the standard control mode.

## MAX PWM

Enter a maximum PWM value to set the maximum desired output for a pulse width modulated (PWM) hydraulic control valve. This setting limits how far the PWM valve will open.

With the machine's master switch in the on position, increase this value until one of the following conditions is met:

- The maximum desired pressure is reached in a liquid system.
- The maximum desired belt speed is achieved in a granular system.

- The maximum spinner speed is achieved for spinner control systems.

**NOTE:** The maximum value for the Max PWM setting is 253.

### MIN PWM

If a PWM type valve is selected as the valve type, enter a minimum PWM value to set the minimum desired output (zero point or shutoff point) for a pulse width modulated (PWM) hydraulic control valve.

With the machine's master switch in the on position, decrease this value until one of the following conditions is met:

- The minimum desired pressure is reached in a liquid system.
- The value when the belt stops moving in a granular system.
- The value when the spinner stops rotating with spinner control.

**NOTE:** The minimum value for the Min PWM setting is 0.

### PRESET PWM

When operating in PWM mode, the preset PWM value sets how far the valve will open to maintain pressure in the system. When the machine's master switch is off, the PWM pulse width will remain at the existing value or go to the preset PWM value, whichever is lower. In PWM close mode, the preset PWM setting is the initial target pulse width when the booms or nodes are turned on. If this value is set to zero, the pulse width will return to the last value when the master switch is turned on.

**NOTE:** If the Standby Pressure feature is enabled on the Feature Settings screen, the preset PWM value will be replaced by the standby pressure value.

### STANDBY PRESSURE

When controlling a liquid product with a PWM valve selected (not PWM close), the standby pressure value sets the pressure which the system will maintain in the product lines when the master or all boom sections are toggled off.

**NOTE:** The standby pressure setting is only accessible when controlling products in liquid control modes with a boom pressure transducer detected. Refer to Feature Settings section on page 29 for details.

**NOTE:** If the system pressure does not reach the set standby pressure, or if the observed pressure oscillates when the master switch section is toggled off, the Sgain value will need to be adjusted. Refer to Sgain (Pressure System Gain - Dual Loop Control Mode Only) section on page 26 for more information on adjusting the Sgain value.

### PWM FREQUENCY

This value sets the frequency of the pulses which are sent to the PWM valve. The default value is 122 Hz for Raven valves, or a value specified by the valve manufacturer.

### PWM OUTPUT DISPLAY

The PWM output display represents the currently programmed min and max PWM values as well as the current PWM output of the valve.

## FEATURE SETTINGS

The current status of the following product control home screen settings is displayed to the right side of the Product Control Calibration settings display:

- Rate Bump (+/-)
- Display Smoothing
- Zero Speed Shutoff
- Implement Switch (NH3 Applicators only)
- Section Control
- PWM Smart Control
- Dual Loop Control
- Standby Pressure
- High Side Drive
- Monitor Section Valve Status (NH3 Applications Only)
- Low Supply Pressure (NH3 Applications Only)

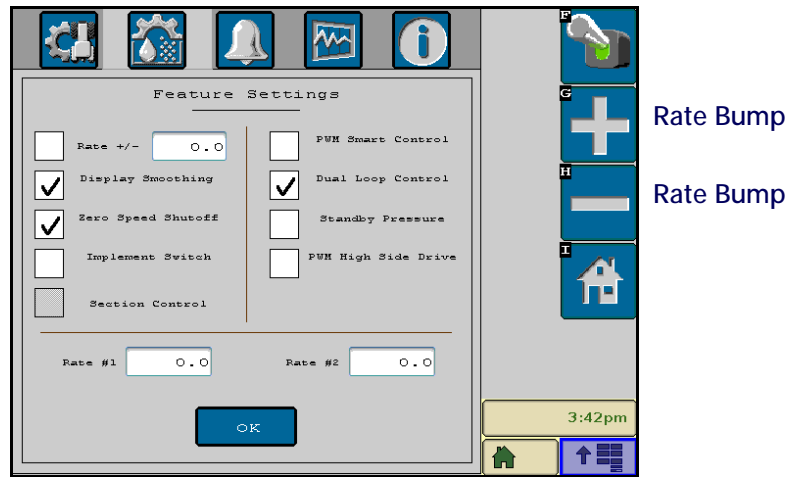

### RATE BUMP (+/-)

If this feature is enabled, the rate bump value sets the increment by which the target rate will increase or decrease when using the rate bump buttons at the right side of the display.

### DISPLAY SMOOTHING

Toggle the display smoothing feature to smooth the rate displayed on the product control home screen. With the feature enabled, as long as the actual rate is within 10% of the actual application rate, the target rate will display as the actual rate on the display. The actual rate will be displayed if the actual rate does not reach the target rate dead band (+/-10%) within 10 seconds.

### ZERO SPEED SHUTOFF

The zero speed shutoff feature will automatically turn off product application if the vehicle speed drops below 0.7 mph [1.1 km/h] while in automatic mode. To restart the system, cycle the master switch 'Off' then back 'On.' A

speed of 0.7 mph [1.1 km/h] must be maintained for more than 10 seconds or the zero speed shutoff feature will shutdown product application.

**NOTE:** To utilize the zero speed shutoff feature, a fast close or PWM close valve must be used to control product flow.

### IMPLEMENT SWITCH

The optional implement proximity switch may be used to shut off application of anhydrous ammonia products if the implement is raised out of the soil to prevent discharging ammonia into the atmosphere. Enable this feature to allow the ISOBUS control node to automatically shut off the product when the implement is raised out of the soil.

**NOTE:** The implement switch feature is only available when the Applicator Type is set to 'NH3 Applicator' and should only be enabled if the optional remote implement switch kit (P/N 117-0171-298) has been installed with the ISOBUS control system. Contact a local Raven dealer for more information.

The implement switch feature is enabled by default when the control type is set to the 'NH3 Applicator' option. If an implement switch has not been installed with the system, this option must be disabled.

### SECTION CONTROL

The section control feature allows the Raven ISOBUS product control node to automatically control sections in reference to coverage maps. When enabled, section control will automatically turn off an active section as it enters an area where product has been previously applied. As the section leaves the previously applied area, the section control feature turns the section back on.

The VT display must be capable of automatic section control to enable the feature. Check the manufacturer operation guides and materials for information on utilizing this feature.

- If the VT is capable of automatic section control and the section control feature is available in the Raven ISOBUS product control screen, select the feature to place a check mark in the corresponding box to enable the feature.
- If the VT display is capable of automatic section control, but the section control feature is not available in the Raven ISOBUS product control screen, the feature must be enabled from a different VT display menu.
- If the VT display is not capable of automatic section control, the Raven ISOBUS product control node will not automatically control sections regardless of the section control selection on the Raven ISOBUS product control screen. It is recommended to deselect or disable this feature when operating the ISOBUS product control system.

### PWM SMART CONTROL

The PWM smart control feature may be enabled to allow the control system to estimate the required PWM duty cycle for changes in vehicle speed or target rate, or when the hydraulic valve is toggled on. When this feature is enabled, control response will be much more aggressive.

### DUAL LOOP CONTROL

The dual loop control feature is designed for use with low application rates and requires a pressure transducer with a liquid application system controlled with a PWM valve. The dual loop feature uses both the flow meter to monitor liquid product flow and a pressure transducer to monitor liquid product pressure controlling a pump to enhance the control response during operation at low application rates. The default setting for this feature is disabled.

If the dual loop control feature is enabled, the valve cal and valve cal 2 values programmed during the initial configuration will be replaced with the flow cal and Sgain values.



### STANDBY PRESSURE (PWM VALVES ONLY)

The standby pressure enable section allows the operator to toggle the standby pressure feature on or off and enter a minimum pressure to maintain all sections or the master switch is turned off. Refer to Preset PWM section on page 28 for information on the standby pressure value.

**NOTE:** To enable the standby pressure feature, the product control system must have a PWM valve controlling a liquid application system and a pressure transducer connected to the control node. If these requirements are not met, standby pressure will automatically be disabled. When enabled, the standby pressure setting will replace the Preset PWM setting on the Valve Calibration screen.

### HIGH SIDE DRIVE

To ensure proper functionality, the high side drive option should be enabled when a PWM boost box is installed.

### RATE 1/RATE 2

Rate 1 and Rate 2 values allow the increase and decrease buttons (+/-) on the Home screen to be replaced with Rate 1 and Rate 2 buttons, allowing the operator to quickly change between two set rates.

To make Rate 1 and Rate 2 buttons available, the following conditions must be met:

- Desired rates for Rate 1 and Rate 2 must be entered (non-zero values)
- Control mode must be set to Auto.

## ALARMS SETUP TAB

In addition to the product control capabilities of the Raven ISOBUS product control system, the ISOBUS communication protocol offers excellent error detection capabilities, making it very suitable and reliable for agricultural applications. Access the Alarms Setup screen to configure the following alert conditions which may be displayed during ISOBUS product control operation:

- Low Tank/Bin
- Low Limit
- Off Rate Percent
- RPM Off Rate Percent (Granular applications only)
- Dual Encoder Error Percent (Granular applications only)
- Bin Level Sensor (Granular applications only)
- Low Pressure (NH3 applications only)

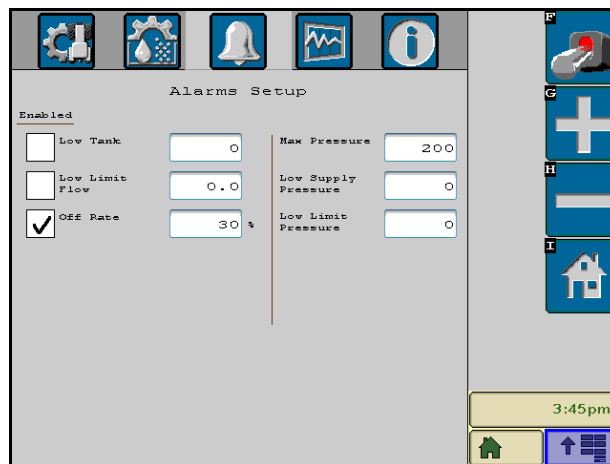

If any of these alarm conditions is detected by the product control node, the corresponding alert will be displayed on the VT display and allow the operator to respond to the condition before resuming application.

**NOTE:** Select the "OK" button on the alarm prompt to clear the alarm and return to the previous screen. The alarm condition may still be present after the alarm prompt is cleared. The product control home screen will continue to display an alarm condition indicator until the issue is resolved.

### LOW TANK

Enable the low tank alarm to display an alert when the calculated volume of product remaining in the tank drops below the desired value.

### LOW LIMIT

The low limit value sets the minimum volume per minute which a product will be applied. If the flow meter drops below this setting, the VT terminal will display an alert.

**NOTE:** The product control valve will stop closing when the low limit setting is reached.

## OFF RATE PERCENT

Enter the percent at which the off rate alarm will activate. The off rate alarm activates when the actual rate differs from the target rate by the programmed value for longer than five seconds.

## RPM OFF RATE PERCENT (GRANULAR APPLICATIONS ONLY)

Set the percent at which the RPM off rate alarm will activate. The RPM off rate alarm activates when the actual RPM differs from the target RPM by the programmed value for longer than five seconds. See the Spinner/Fan Control Setup section on page 22 for details on calibrating an RPM control valve.

## DUAL ENCODER ERROR PERCENT (GRANULAR APPLICATIONS ONLY)

In Gran 3 (dual bed, dual encoder) systems, a dual encoder error may be displayed when the encoder rates differ by the selected value for more than five seconds.

**NOTE:** The dual encoder error alarm prompt will not be displayed if the control type is not set to Gran 3.

## BIN LEVEL SENSOR (GRANULAR APPLICATIONS ONLY)

If a bin level sensor has been installed, enable this alarm to alert the operator when the level of product remaining in the bin falls below the bin sensor.

## LOW LIMIT PRESSURE SETTING

Enter the desired pressure for product at the pressure transducer location.

**NOTE:** The product control valve will stop closing then the low pressure setting is reached.

## LOW SUPPLY PRESSURE SETTING (ACCUFLOW HP PLUS APPLICATIONS ONLY)

Enter the desired minimum supply pressure that must be measured to allow the boost pump to engage.

**NOTE:** The product boot pump will disable when the low pressure setting is reached.

## LOW PRESSURE ALARM (ACCUFLOW HP APPLICATIONS ONLY)

The low pressure alarm is displayed if the control type is set to 'NH3 Applicator' and requires a transducer to measure the pressure of the anhydrous ammonia product currently being applied. Enable the low pressure alarm and enter a percentage value below the target pressure which the VT console will display an alarm condition.

**NOTE:** The product control valve will stop closing when the Low Pressure setting is reached.

## PUMP FAULT ALARM (ACCUFLOW HP PLUS APPLICATIONS ONLY)

A pump fault alarm will signal and eventually the pump control will be disengaged if the pump control reached its maximum value but the outlet pressure did not increase above the inlet pressure.

## INFORMATION

Select the information icon to view the ISOBUS product control node hardware and software version numbers.



## DIAGNOSTICS

### CONTROL DIRECTION

Control direction indicators are displayed for installed valves and pumps.

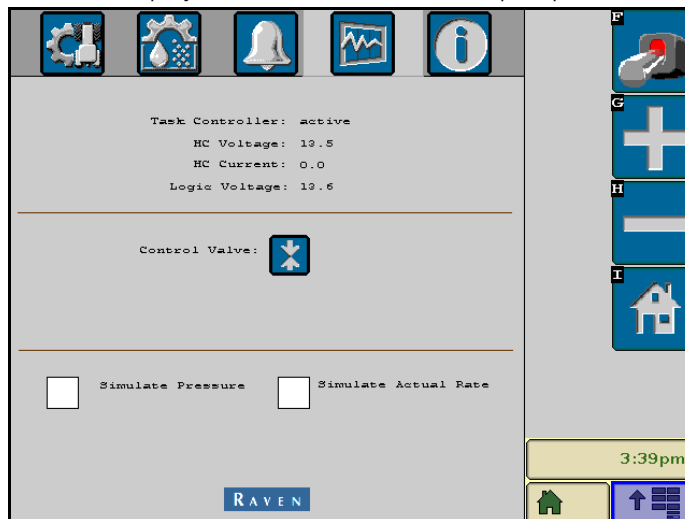

### PRESSURE OR FLOW SIMULATION

Optional check boxes that simulate pressure or flow are included. To simulate pressure, check the box and enter a pressure value into the pressure cal inputs. If the simulate flow box is checked, the actual rate will report the entered target flow rate on the front screen and the flow rate on the totals screen will adjust with speed and operating section width. When either simulation mode is engaged, a "Demo Mode" warning will display on the product control home screen.

# CHAPTER

# 5

# ISOBUS PRODUCT CONTROL OPERATION

## PRODUCT CONTROL HOME SCREEN

With the product control node properly installed and calibrated, the VT display can be used to monitor and control product application without the need for additional consoles or displays in the vehicle cab. Select the product control icon located in the VT display menu to view the main product application screen.



**ISOBUS  
Product**

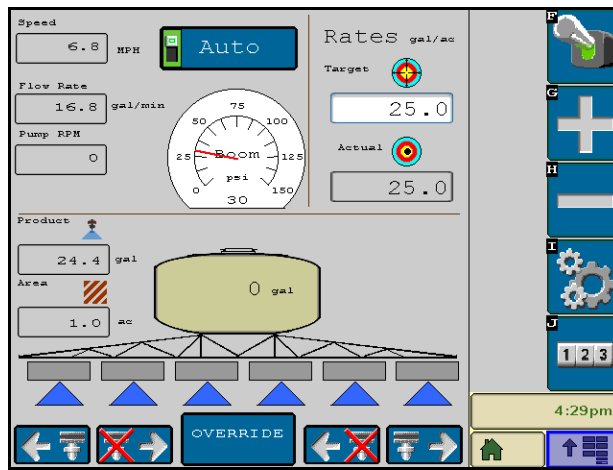

From the product control home screen, the machine operator can monitor and control the following aspects of the product control system:

• Master (Switch) Status	• Product Density (Granular Applicators)	• Target Pressure (NH3 Applicators)	• Remaining Tank/ Bin Volume
• Control Mode (Auto/Manual)	• Pressure or Fan/ Spinner RPM	• Volume Applied	• Section Status Display
• Application Speed	• Rates Area	• Area Covered	• Manual Section Controls
• Pump Status (NH3 Applicators)			

## QUICK ACCESS SOFTKEYS

The quick access softkeys allows the operator to quickly access frequently used functions as well as the calibration and configuration screens.

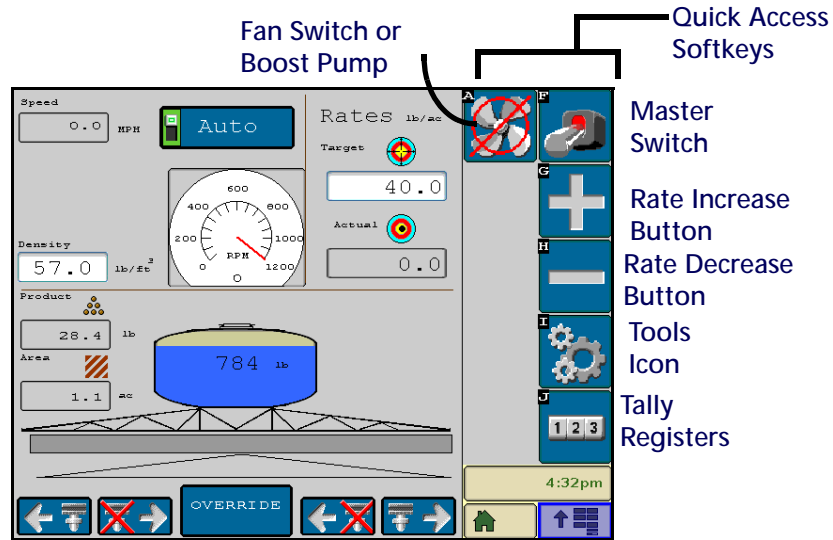

### MASTER SWITCH

The status of the master switch is displayed in the quick access bar. Select the switch status indicator to toggle the master switch.

**NOTE:** Both the remote master (foot switch) and the master switch indicator must be toggled on to apply product. See the Remote Master Status section on page 39 for more information on the remote master switch.

### RATE INCREASE/DECREASE BUTTONS

Use the rate increase and decrease buttons to adjust the target or actual application rate based on the control mode (auto/manual) currently selected.

**NOTE:** When Rate 1 and Rate 2 are set as described in Rate Bump (+/-) section on page 29, the increase/decrease (+/-) buttons are replaced with Rate 1/Rate 2 buttons.

### TOOLS ICON

Select the tools icon to access the calibration screens. See Chapter 4, ISOBUS Product Control Node Calibration, for more information.

### TALLY REGISTERS

Select the tally registers icon to view the volume and area registers. See the Tally Registers section on page 46 for more information on the tally registers.

### FAN SWITCH OR BOOST PUMP STATUS

If a dry or granular product type is selected, a fan switch status indicator will be available in the quick access softkeys area. Select this indicator to toggle the fan switch on or off.

If the NH3 Applicator product control type is selected, a boost pump status indicator will be available in the quick access softkeys area. Select this indicator to toggle the AccuFlow HP boost pump on or off. Refer to the AccuFlow and AccuFlow HP Installation and Operation Manual for details on operating the boost pump.

**NOTE:** The fan switch or boost pump switch status indicator must be toggled on or off manually. The fan or pump will not be toggled automatically when the master or remote master switch is operated.

### REMOTE MASTER STATUS

The current status of the remote master is shown in the top, center of the display. To toggle the remote master, press the foot switch.

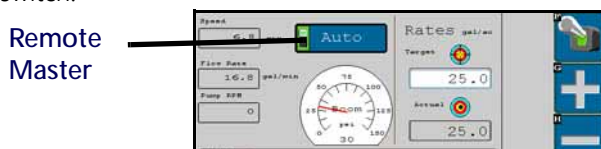

**NOTE:** Both the remote master (foot switch) and the master switch must be toggled on to apply product.

### CONTROL MODE (AUTO/MANUAL)

The control mode indicator displays the selected mode for product application. Select the “Auto/Manual” button to toggle the application mode between automatic and manual. The active mode displays green in the control mode display area.



- Manual mode allows the operator to control the actual application rate directly using the on-screen increase and decrease buttons.
- In automatic mode, the product control system automatically adjusts the application rate to an operator set target rate. Using the rate increase or decrease buttons in auto mode adjusts the target application rate.



### APPLICATION SPEED

The current vehicle speed is displayed on the product control home screen.

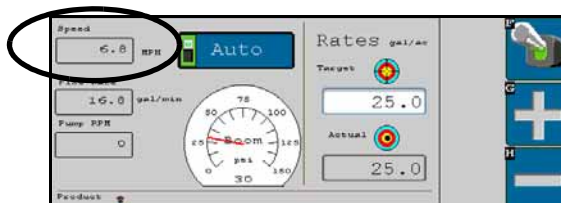

### PUMP RPM CAL (SPRAY APPLICATOR)

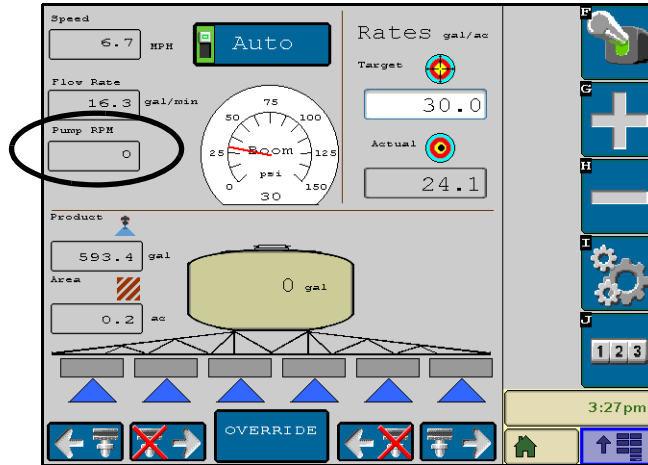

The current pump RPM is displayed in this area when a Pump RPM Cal value is entered. Refer to Pump RPM Cal section on page 20 to set the Pump RPM Cal value.

### PRODUCT DENSITY (GRANULAR APPLICATIONS)

Select the density value to enter the product density of the product being applied. For best results, make sure to keep this value updated as the density of the product changes.

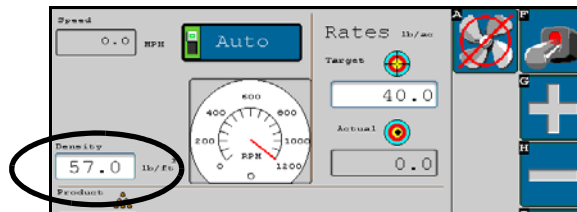

### TARGET PRESSURE (NH3 APPLICATIONS)

The currently set target pressure for the NH3 boost pump displays in this area. Refer to the Pressure or Spinner/Fan RPM Display section below for details on changing the boost pump target pressure.

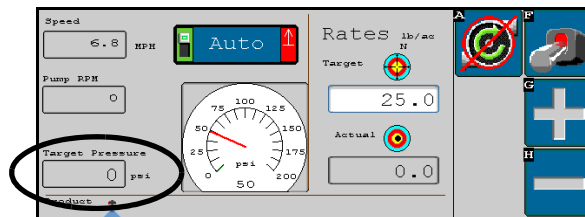



PRESSURE OR SPINNER/FAN RPM DISPLAY

A pressure (liquid and NH3 applications) or RPM (granular applications) gauge is displayed in the upper, center of the product control home screen.

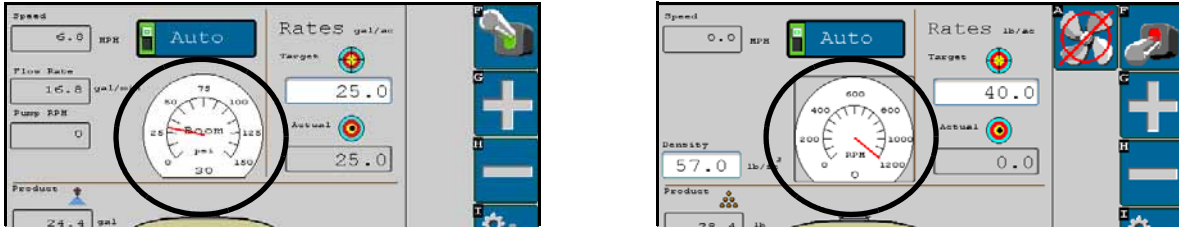

HP PRESSURE OR SPINNER/FAN CONTROL

If the control type selection is set to "Spreader - Spinner" or "NH3 Applicator," select the gauge displayed on the product control home screen to view either the HP Pressure or Spinner/Fan Control screen.

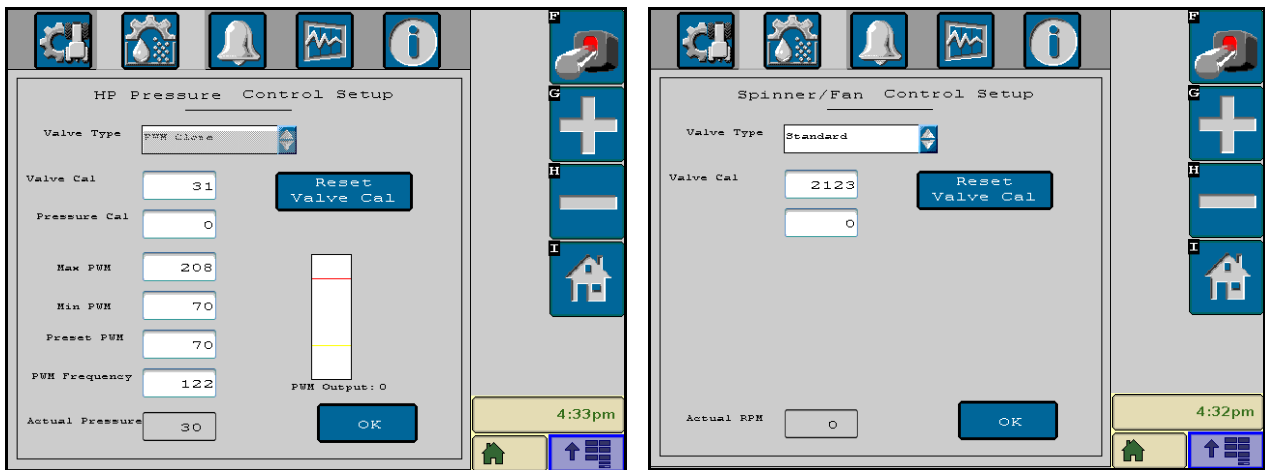

**Control Mode (Auto/Manual).** The control mode indicator displays the selected mode for pressure or RPM control. Select the "Auto/Manual" button to toggle the application mode between automatic and manual. The active mode displays green in the display.

- Manual mode allows the operator to control the actual pressure or RPM manually. Select the increase or decrease buttons while viewing the HP Pressure Control or Spinner/Fan Control screen to manually increase or decrease the pressure or spinner/fan RPM.
- In Automatic mode, the product control system automatically adjusts the application rate to an operator set target rate. The increase and decrease buttons will have no affect on the pressure or RPM values in automatic mode. Refer to the Target Pressure or RPM section below to change the target pressure or RPM in automatic mode.

**Target Pressure or RPM.** Select the target pressure or RPM field and use the on-screen keypad to set a target pressure for the AccuFlow HP boost pump or a target RPM for the spinner or fan.

Enter the desired target pressure to maintain in the anhydrous ammonia application lines. The pressure cal may be set between 0 and 250 PSI [0 and 1724 kPa].

**NOTE:** For best results, set the boost pump target rate 5 to 10 PSI [34 to 68 kPa] above the static tank pressure. If the boost pump pressure is set too high, excess vapor will form in the supply lines. If vapor builds up in the supply lines, the boost pump may become vapor locked which results in no pressure boost.

OK. Select the OK button at the bottom of the screen to accept the settings currently displayed on the screen and return to the product control home screen.

## RATES AREA

The application rates area displays the actual and target rate information as well as the currently selected units in which the information is displayed.

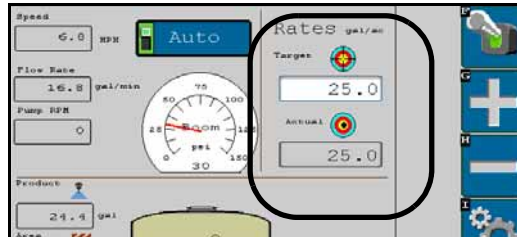

**Target Rate.** Select the target value to enter the target rate for the current application (i.e. 15 gallons per acre or 140 liters per hectare).

**NOTE:** Verify that the meter cal entered in the Raven ISOBUS product control system is configured for the same units as the target rate to be applied. When controlling an anhydrous ammonia (NH<sub>3</sub>) applicator, the recommended units for the target rate and meter cal values is pounds [kilograms]. Refer to the AccuFlow or AccuFlow HP Calibration and Operation Manual for the anhydrous ammonia control system for more information on calibrating the meter cal.

**Actual Rate.** The actual rate display shows the operator the actual volume of product being applied.

## REMAINING TANK/BIN VOLUME

The calculated volume of product remaining in the tank or bin is displayed in the lower, center of the product control home screen. Tank Capacity and Current Tank volume can be entered either through the tank button on the home screen or through the product control calibration tab, these values will be reflected in the tank icon on the home screen. The current tank volume value will adjust as product is applied. If a meter is installed in the system to monitor filling, enter the Fill Meter Cal value on this screen and the Current Tank Volume value will adjust during the fill process.

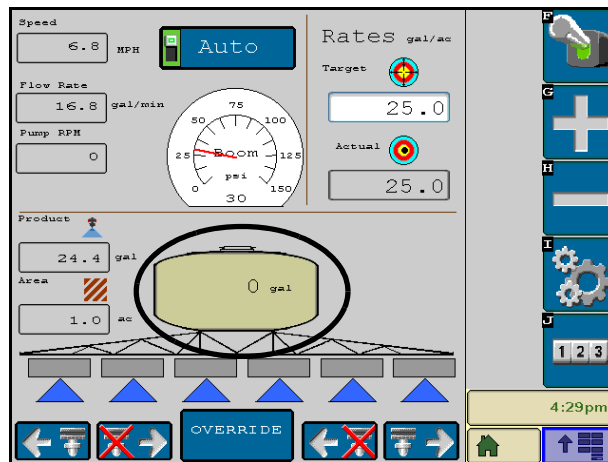

**NOTE:** The tank volume value must be entered in the same units used for the meter cal value. Be sure to adjust the entered tank volume using the same units or calibration as the meter cal and target rate settings. For anhydrous ammonia applicators, the recommended values is pounds [kilograms] of anhydrous ammonia.

## VOLUME/WEIGHT APPLIED

To the left of the tank volume display, the product control home screen displays the volume or weight of product applied.

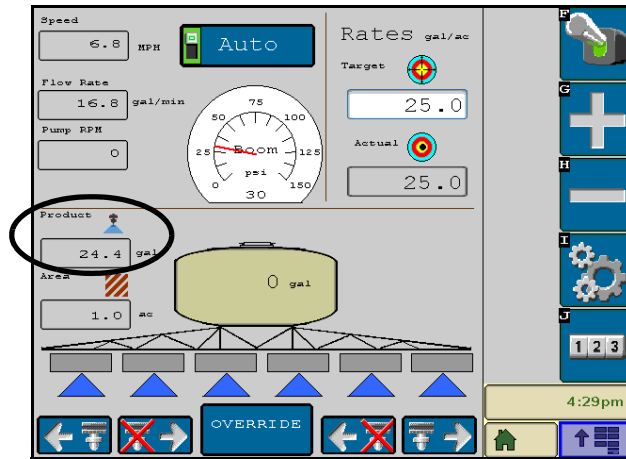

**NOTE:** To reset the field volume, select the tally registers icon on the right side of the screen. For more information on the Tally Registers screen, see the Tally Registers section on page 46.

## AREA COVERED

To the right of the tank volume display, the product control home screen displays the area covered.

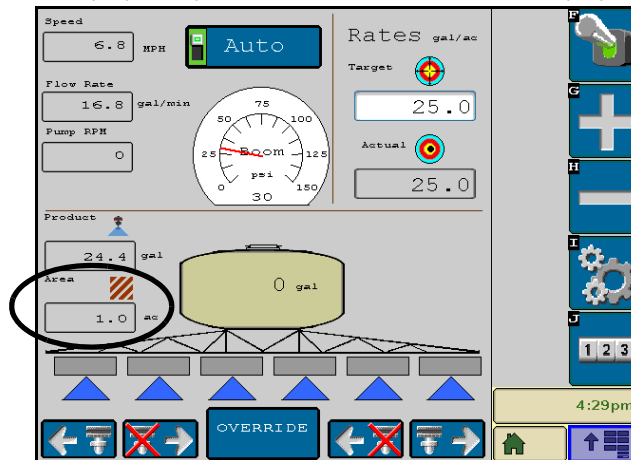

**NOTE:** To reset the field area, select the tally registers icon on the right side of the screen. For more information on the tally registers screen, see the Tally Registers section on page 46.



## INJECTION PUMP STATUS BUTTON

If a Raven Sidekick Pro ISO injection pump is connected to the product control system, the Product Control Home screen will display a pump status button for each detected pump (maximum of three pumps) on this screen.

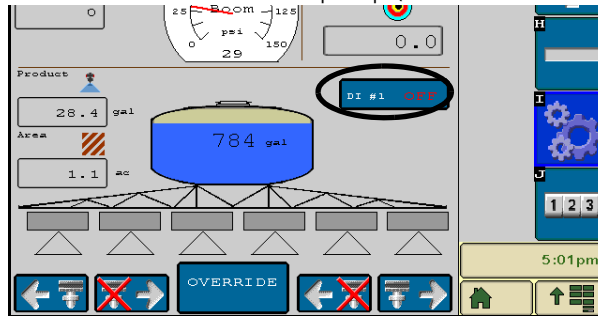

Touch this button to toggle the selected ISO injection pump on or off.

## SECTION STATUS DISPLAY

Below the tank volume display, the status of each configured section is displayed.

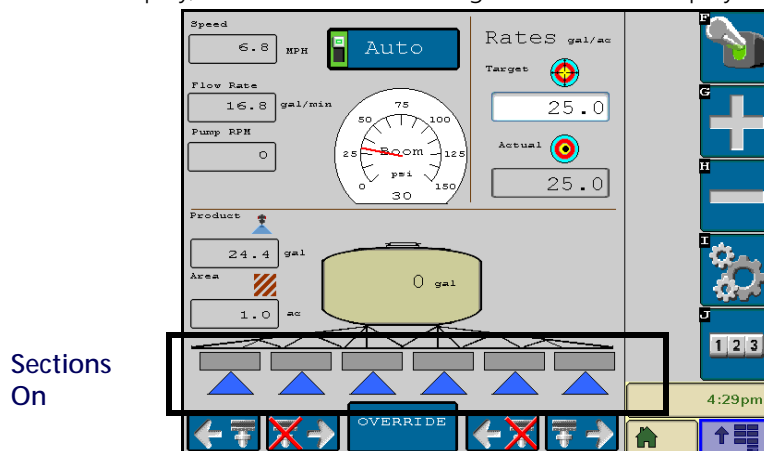

**NOTE:** Refer to the Implement Calibration Tab section on page 15 to configure sections.

Manually disabled sections are displayed without a triangle below the section. See the On-Screen Manual Section Controls section on page 45 for using manual section controls.

A triangle will be displayed below sections which are enabled for product application. When the product application is turned off, the section indicators will be empty. When the application system is toggled on, each active section will turn green.

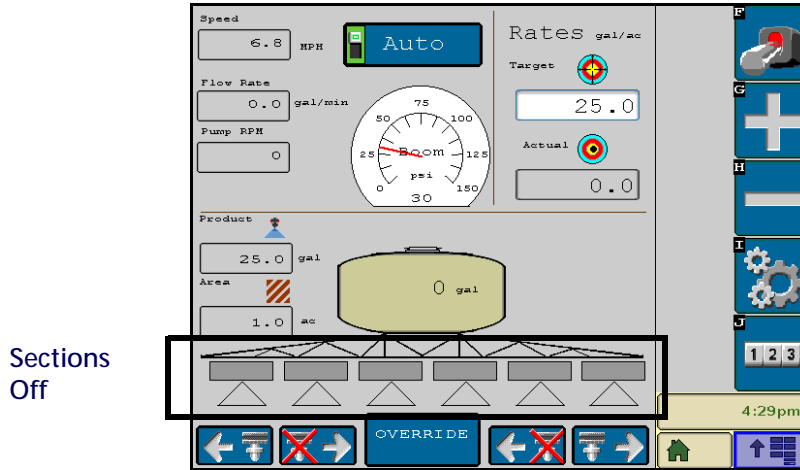

### ON-SCREEN MANUAL SECTION CONTROLS

**NOTE:** The on-screen manual section controls will only be displayed if an optional Raven ISO Switch Box is not detected on the ISOBUS. If a switch box is detected, use the switch box to manually control implement sections or to enable the override feature.

The “ON” and “OFF” buttons at the bottom of the product control home screen may be used to manually enable or disable sections.

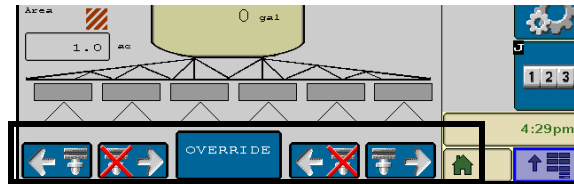

To disable sections from the left or right side of the implement, select the corresponding “OFF” button. Each time the “OFF” button is selected, the furthest enabled section on the corresponding side of the implement will be disabled. To toggle sections back on, select the corresponding “ON” button.

Disabled Sections



#### FOR EXAMPLE:

Select the “OFF” button on the left side of the screen to disable the far left section. Selecting the “OFF” button repeatedly will continue disabling sections from left to right. Press the “ON” button on the left side of the screen to enable sections from right to left.

**NOTE:** Any combination of manual on or off section controls may be used to toggle all but one section off. To turn off the last section, the remote master or master switch softkey must be toggled to the off position.

When the remote master or master switch softkey is toggled back on, any sections manually disabled will still be disabled. Use the “ON” buttons to enable sections as necessary.

SECTION OVERRIDE

**NOTE:** The override button will only be displayed if an optional Raven ISO Switch Box is not detected on the ISOBUS. If a switch box is detected, use the switch box to manually control implement sections or to enable the override feature.

Use the override button at the bottom of the Product Control Home screen to override all sections on for 5 seconds. After five seconds, the system will resume automatic control operations base upon previous coverage.

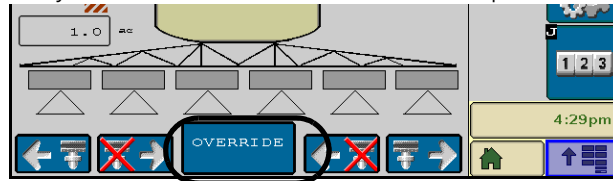

TIERED BOOM STATUS DISPLAY

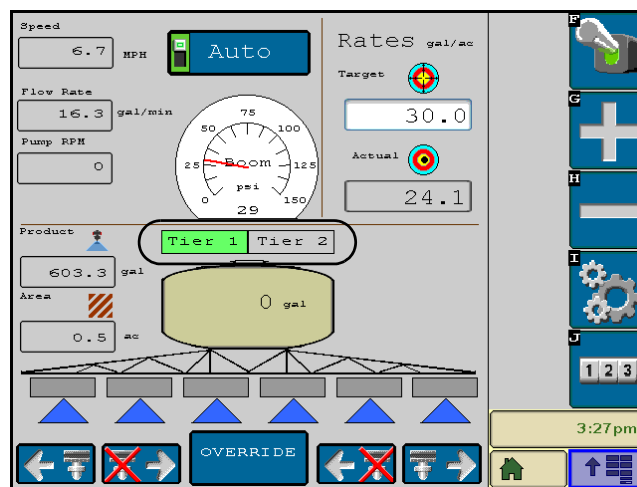

Above the tank volume display, a tiered boom status display will indicate tier 1 and tier 2 status. The tier stats will be displayed only if the tiered boom settings were entered. Refer to the Tiered Boom Settings section on page 22 for further information on setting up tiered booms.

TALLY REGISTERS

The Raven ISOBUS system is capable of tracking two separate registers to keep records for the area covered and volume applied to a field or over a period of time. The following tallies may be reset or recalibrated by the operator at any time:

- Field Area
- Field Volume/Weight
- Total Area

- Total Volume/Weight

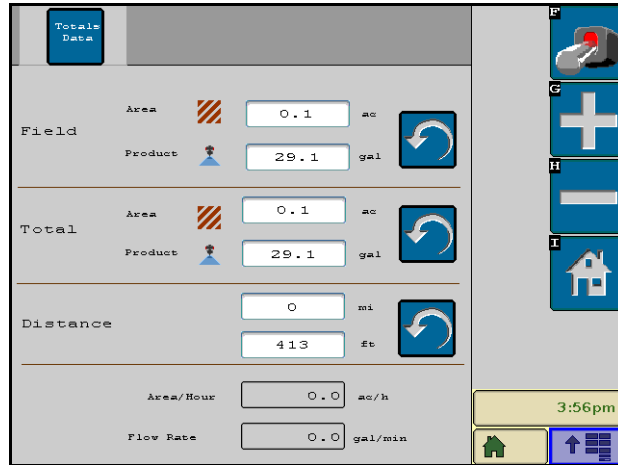

In addition to the area and volume tallies, the tally registers screen also displays the distance traveled and the current volume per minute and area per hour.

### FIELD AREA AND VOLUME

The field area and volume totals may be used to keep records of product application in a field or throughout a day's operation. Select the "-> 0" button next to the desired setting to reset the register to zero.

### TOTAL AREA AND VOLUME

The area and volume totals may be used to keep record of long term area and volume information (i.e. product application over a week or month). Select the "-> 0" button next to the desired setting to reset the register to zero.

### DISTANCE

The distance reading displays the distance traveled since the last time the distance register was cleared. Select the "-> 0" button to reset the distance register to zero. This display may also be helpful when troubleshooting the product control system.

### VOLUME PER MINUTE DISPLAY

During product application, the current volume of product applied per minute rate is displayed in this area. This value may be helpful when troubleshooting the product control system.

### AREA PER HOUR DISPLAY

During product application, the current area covered per hour is displayed in this area. This value may be helpful when troubleshooting the product control system.







---

# CHAPTER

# TROUBLESHOOTING

## 6

---

Problem	Action
1. Rate reads "0."	<ul style="list-style-type: none"><li>• Verify SPEED is registering accurately. If SPEED is zero, refer to the VT display troubleshooting procedure.</li><li>• Verify TOTAL VOLUME is registering flow. If not, refer to problem 6.</li></ul>
2. Rate inaccurate or unstable.	<ul style="list-style-type: none"><li>• Verify that all calibration numbers and settings keyed into the console are correct. Verify SPEED is registering accurately. If SPEED is inaccurate, refer to the VT display troubleshooting procedure.</li><li>• In MAN (manual) operation, verify that RATE display holds constant. If not, refer to problem 7.</li><li>• Confirm that boom section status shown on the display is not changing.</li><li>• In MAN (manual) operation, check low end and high end pressure range. If pressure cannot be adjusted manually, refer to problem 6.</li></ul>
3. Cannot verify rate in manual operation or in auto.	<ul style="list-style-type: none"><li>• Check cabling to motorized control valve for breaks.</li><li>• Check connections in cabling for cleanliness.</li><li>• Verify that there is voltage at the valve connector by toggling master switch ON; AUTO/MAN switch to MAN; and POWER ON. Manually operate INC/DEC switch to verify voltage.</li><li>• Verify that valve is turning, if not, replace control valve.</li></ul>
4. Sprayer pressure is correct but RATE is low.	<ul style="list-style-type: none"><li>• Verify that nozzle strainer screens or check valves are not plugged.</li><li>• Verify that pressure at each boom is the same.</li><li>• Verify all nozzles are of proper and same orifice size. See Appendix 8, Calculating the Calibration Values.</li></ul>
5. Total volume does not register.	<ul style="list-style-type: none"><li>• Check flow meter/encoder cable for breaks and shorts. See the Testing the Flow Meter/Encoder Cable section on page 71.</li><li>• Check the internal components of the flow meter/encoder; clean and adjust. Appendix C, Flow Meter Maintenance and Adjustment Procedure for flow meter cleaning and adjustments.</li><li>• Replace flow meter transducer/encoder.</li></ul>
6. Total volume registers flow inaccurately.	<ul style="list-style-type: none"><li>• Verify that arrow on flow meter is pointing in direction of flow.</li></ul>
7. Motorized control valve rotates more than 1/4 turn.	<ul style="list-style-type: none"><li>• Replace motorized control valve.</li></ul>

Problem	Action
8. Water inside cover of motorized control valve.	<ul style="list-style-type: none"> <li>• Replace isolation flange assembly and coupler shaft.</li> <li>• Replace entire motorized control valve if PC board or motor is corroded and will not run.</li> </ul>
9. Boom valve(s) will not operate.	<ul style="list-style-type: none"> <li>• Check cable for wires with breaks.</li> <li>• Check connectors for cleanliness.</li> <li>• Check BOOM switch and MASTER switch for operation.</li> <li>• Replace boom valves.</li> </ul>
10. System does not enable in 'NH3 Applicator' mode.	<ul style="list-style-type: none"> <li>• If the control type is set to 'NH3 Applicator' and no proximity switch has been installed, disable the 'Implement Switch' feature on the Product Control Calibration Tab. See the Feature Settings section on page 29 for details.</li> </ul>
11. Boost pump pressure (AccuFlow HP systems) does not increase or reach target pressure.	<ul style="list-style-type: none"> <li>• Refer to AccuFlow and AccuFlow HP Installation and Operation manual for boost pump troubleshooting procedures.</li> <li>• Verify that the pressure cal is calibrated correctly and the correct target pressure is entered.</li> <li>• The low limit pressure is not set correctly for operating conditions. The low limit will shut down the system if the limit is reached.</li> </ul>

7

The following diagrams illustrate the proper installation of the Raven ISOBUS product control node with various VT displays. These diagrams are good examples for both factory and aftermarket installations.

FIGURE 1. ISOBUS Trunk Line Cabling

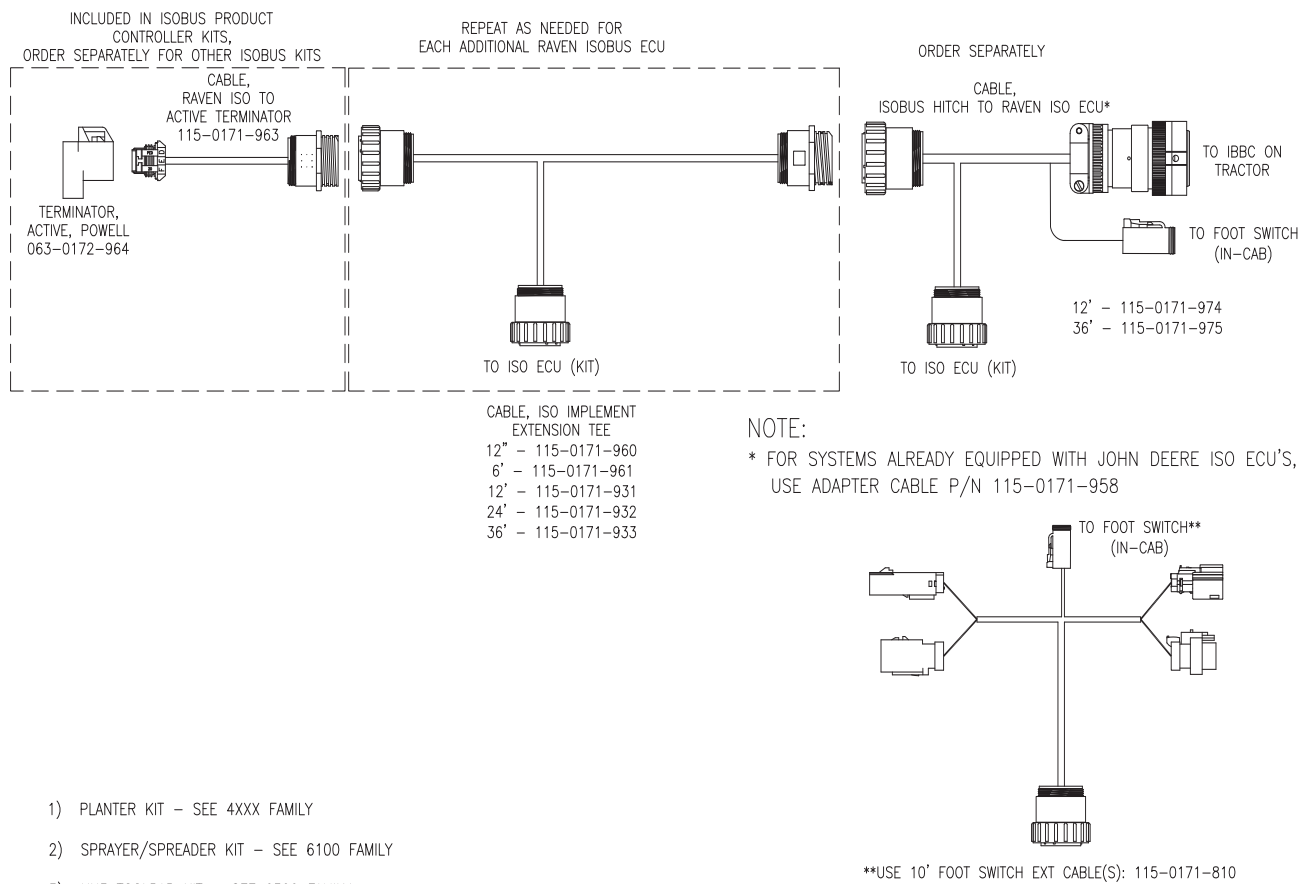

- 1) PLANTER KIT - SEE 4XXX FAMILY
- 2) SPRAYER/SPREADER KIT - SEE 6100 FAMILY
- 3) NH3 TOOLBAR KIT - SEE 6300 FAMILY

FIGURE 2. ISOBUS Liquid Product Control System (16-pin Product Cable)

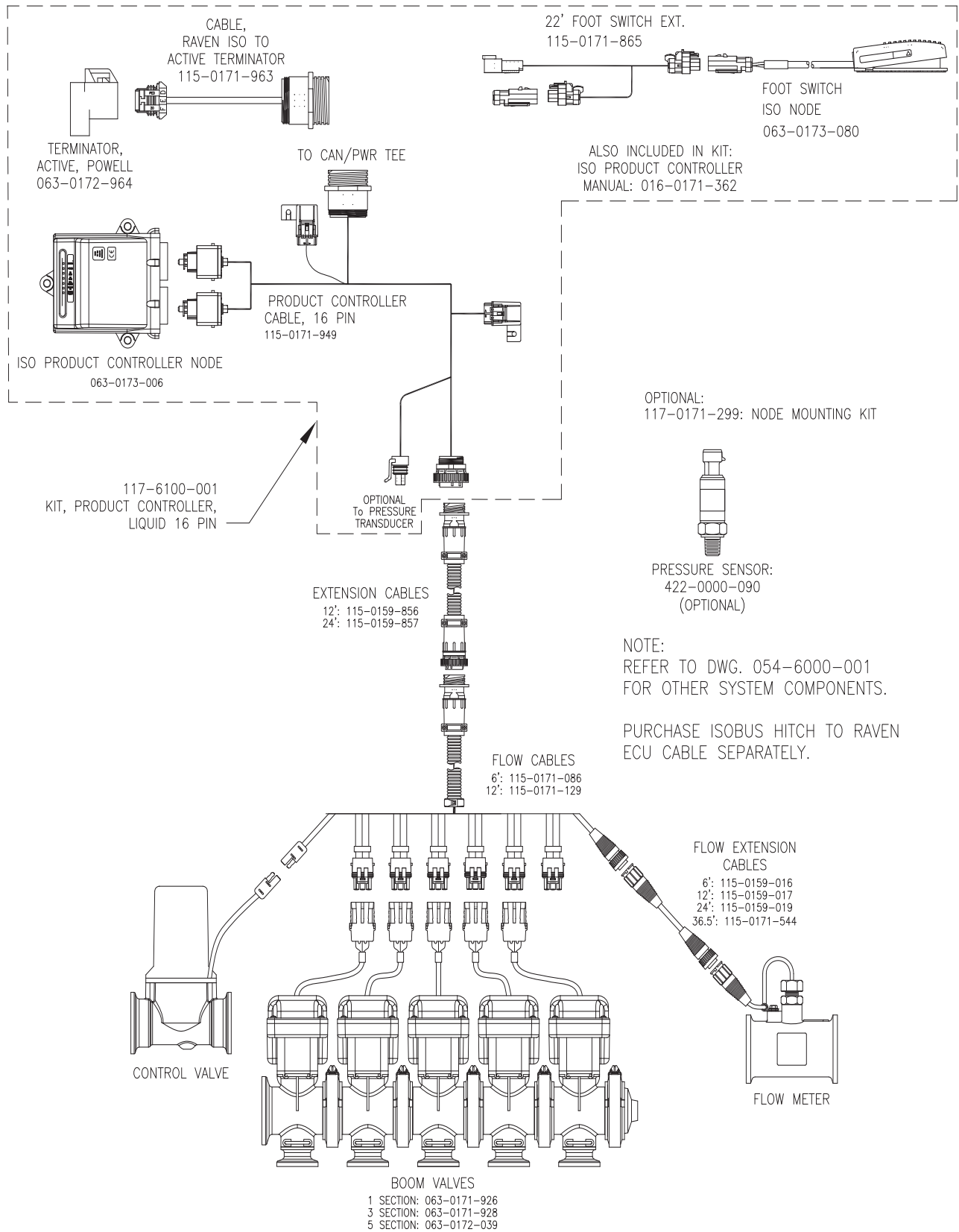

**FIGURE 3. ISOBUS Granular Product Control System (37-pin Product Cable)**

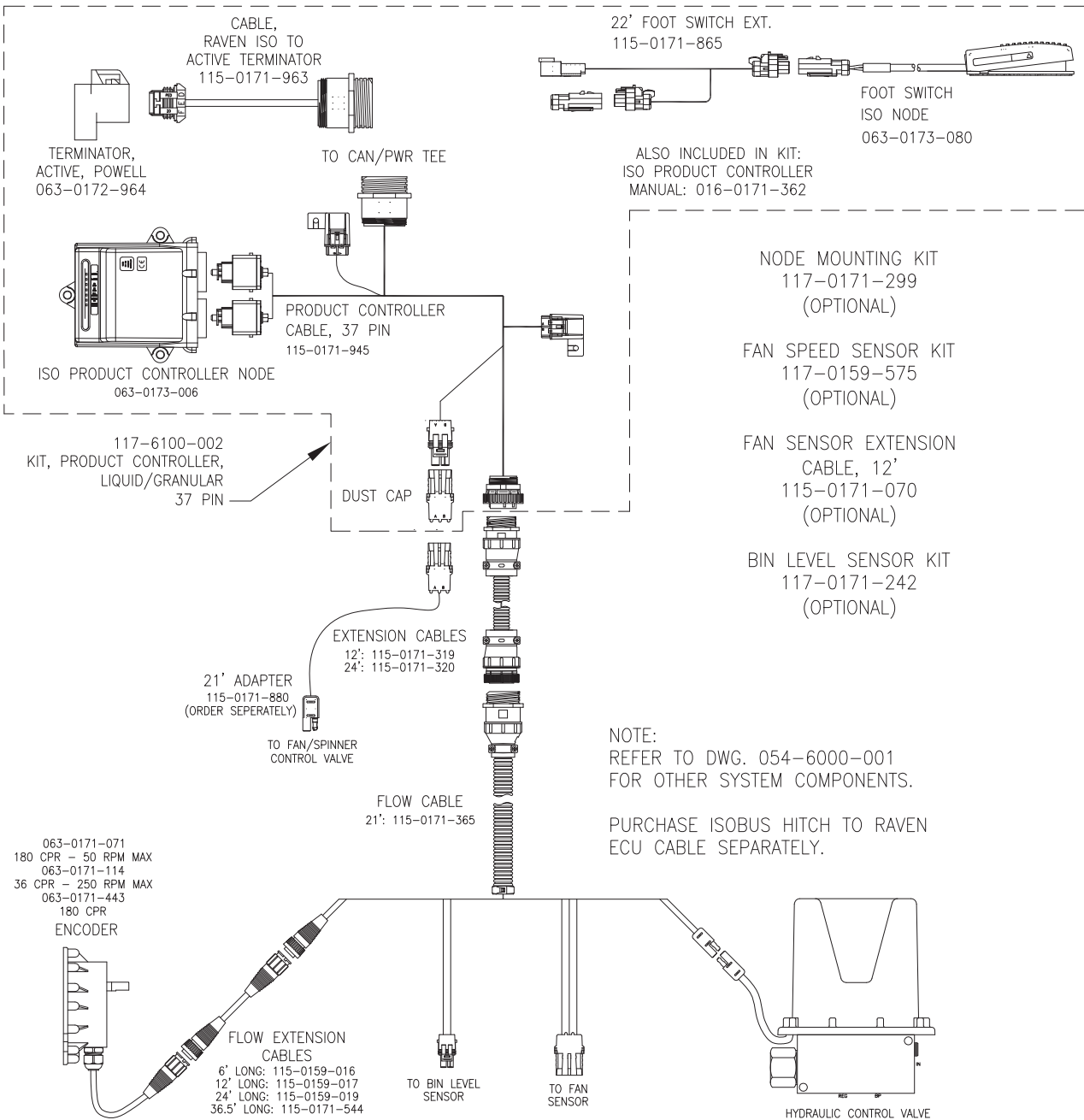
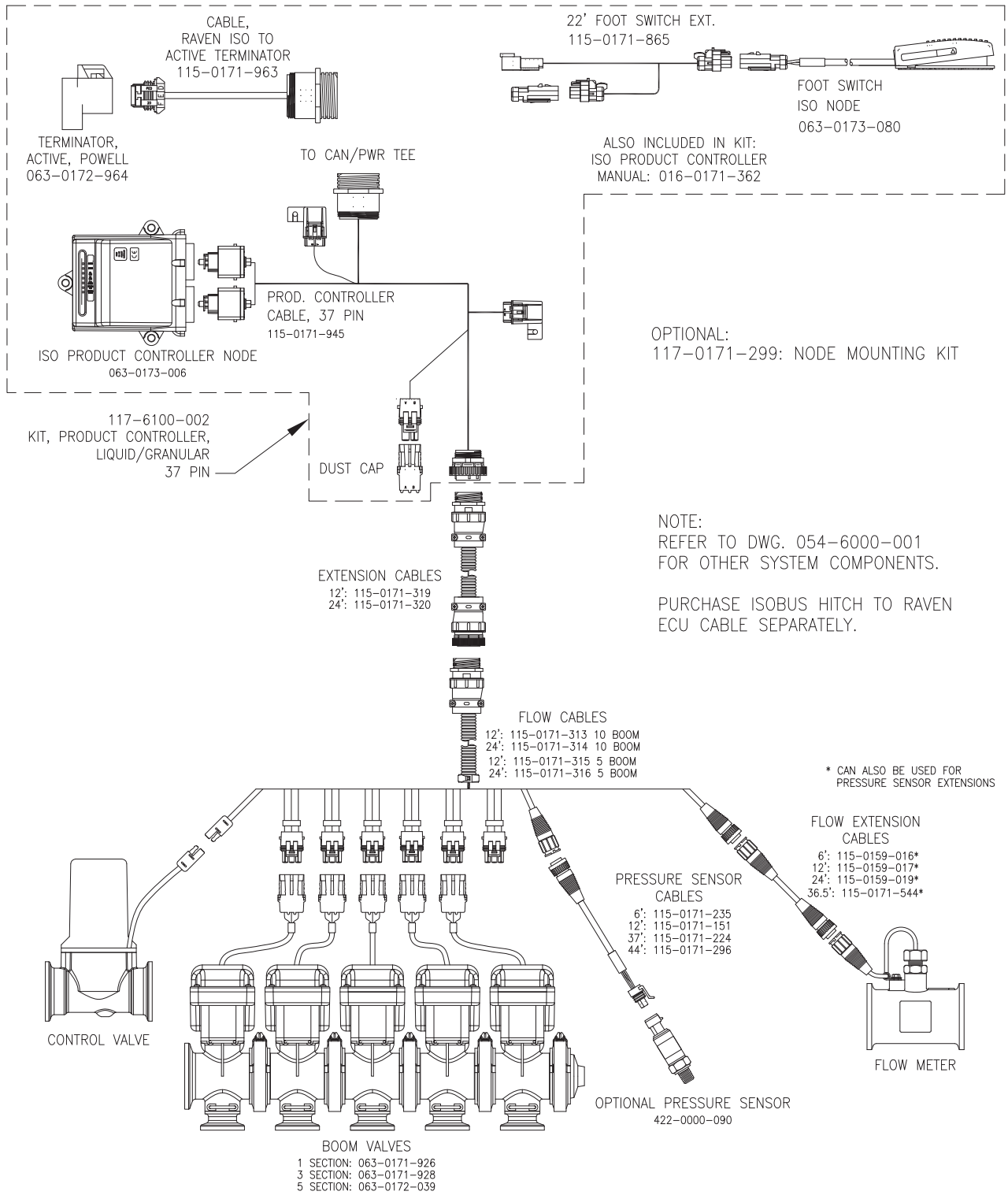

FIGURE 4. ISOBUS Liquid Product Control System (37-pin Product Cable)



**FIGURE 5. ISOBUS Liquid Product Control System (22-pin Product Cable)**

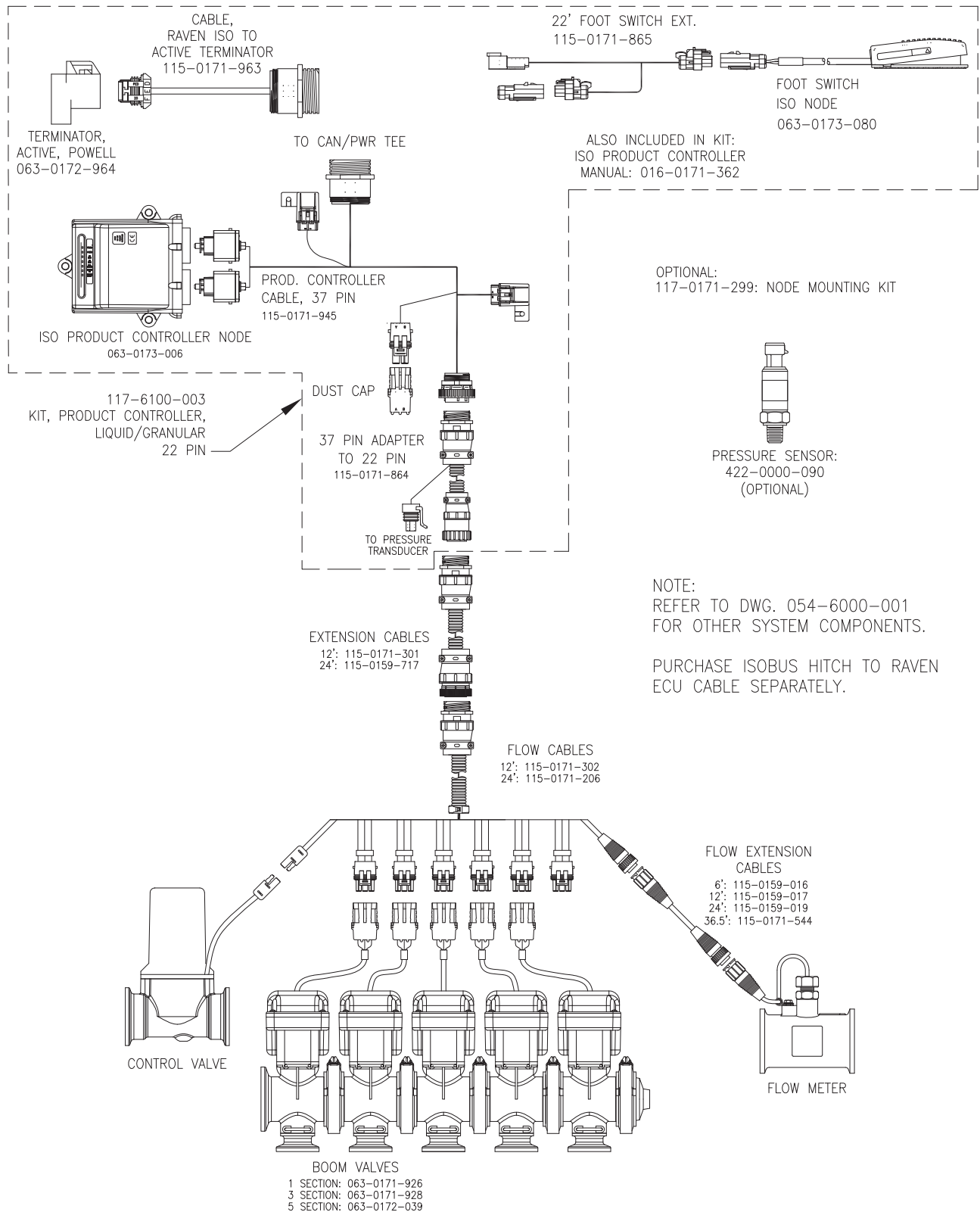

FIGURE 6. ISOBUS Granular Product Control System (22-pin Product Cable)

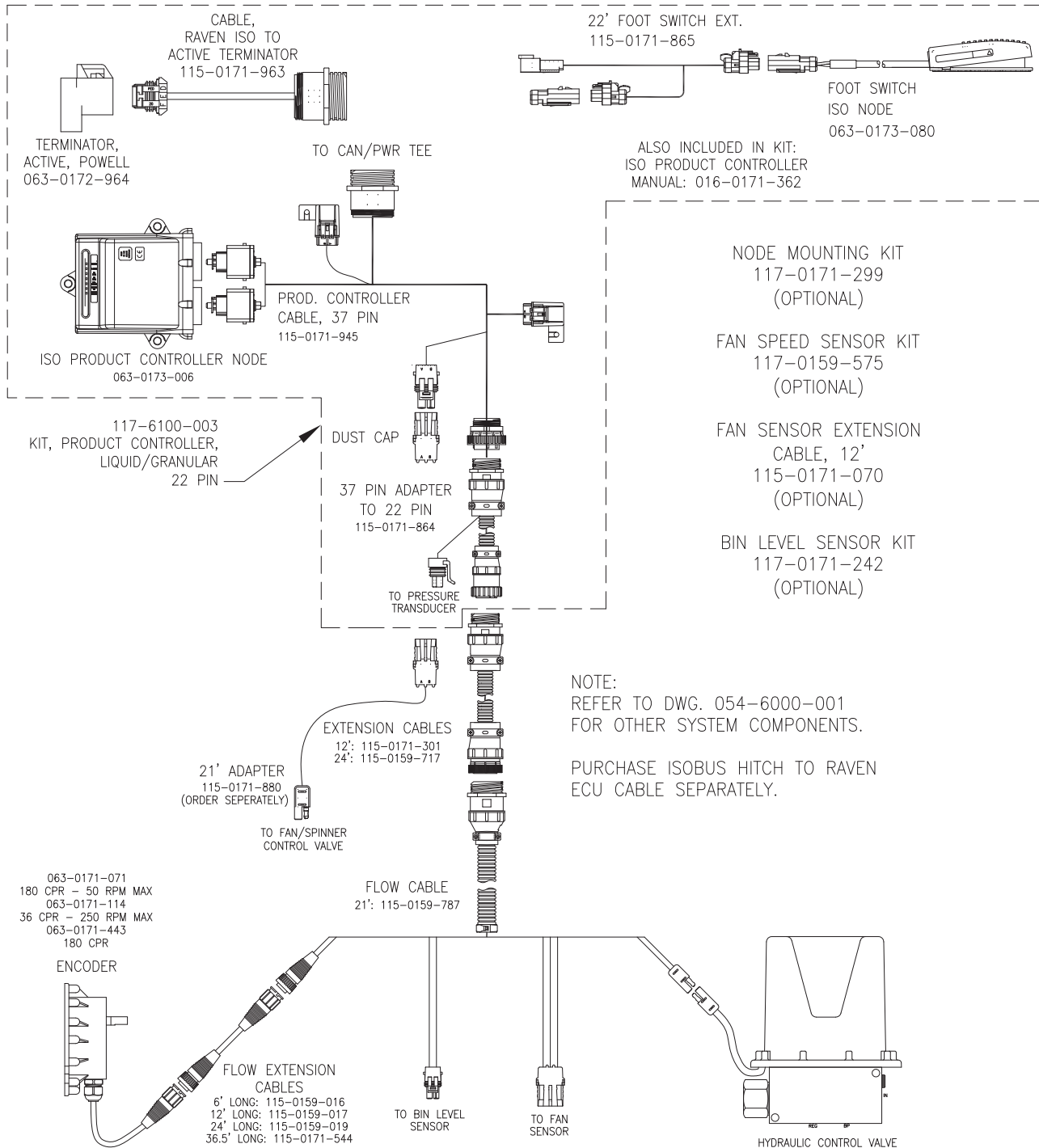



FIGURE 7. ISOBUS AccuFlow HP (3 Section Bar)

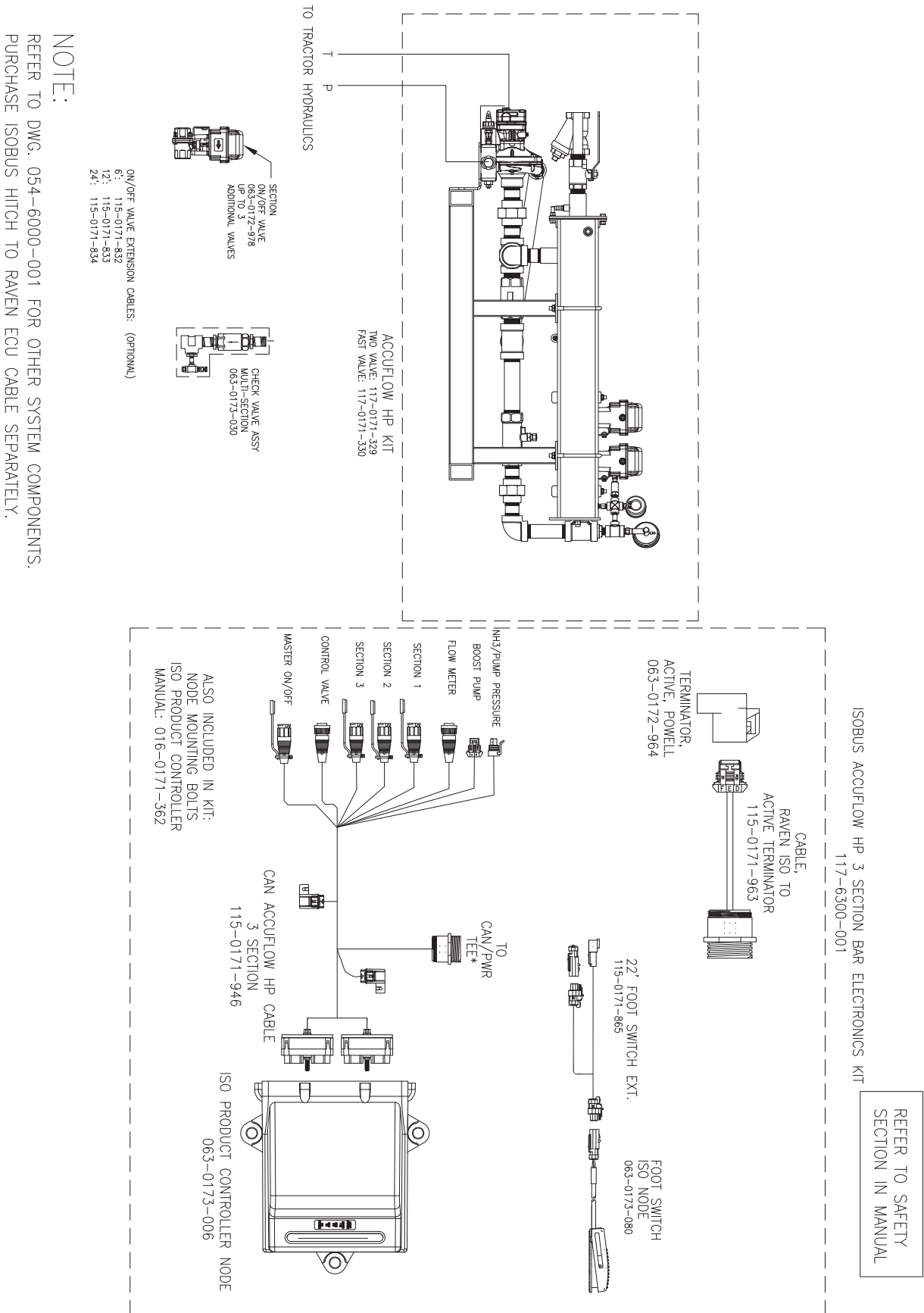

FIGURE 8. ISOBUS AccuFlow (3 Section Bar)

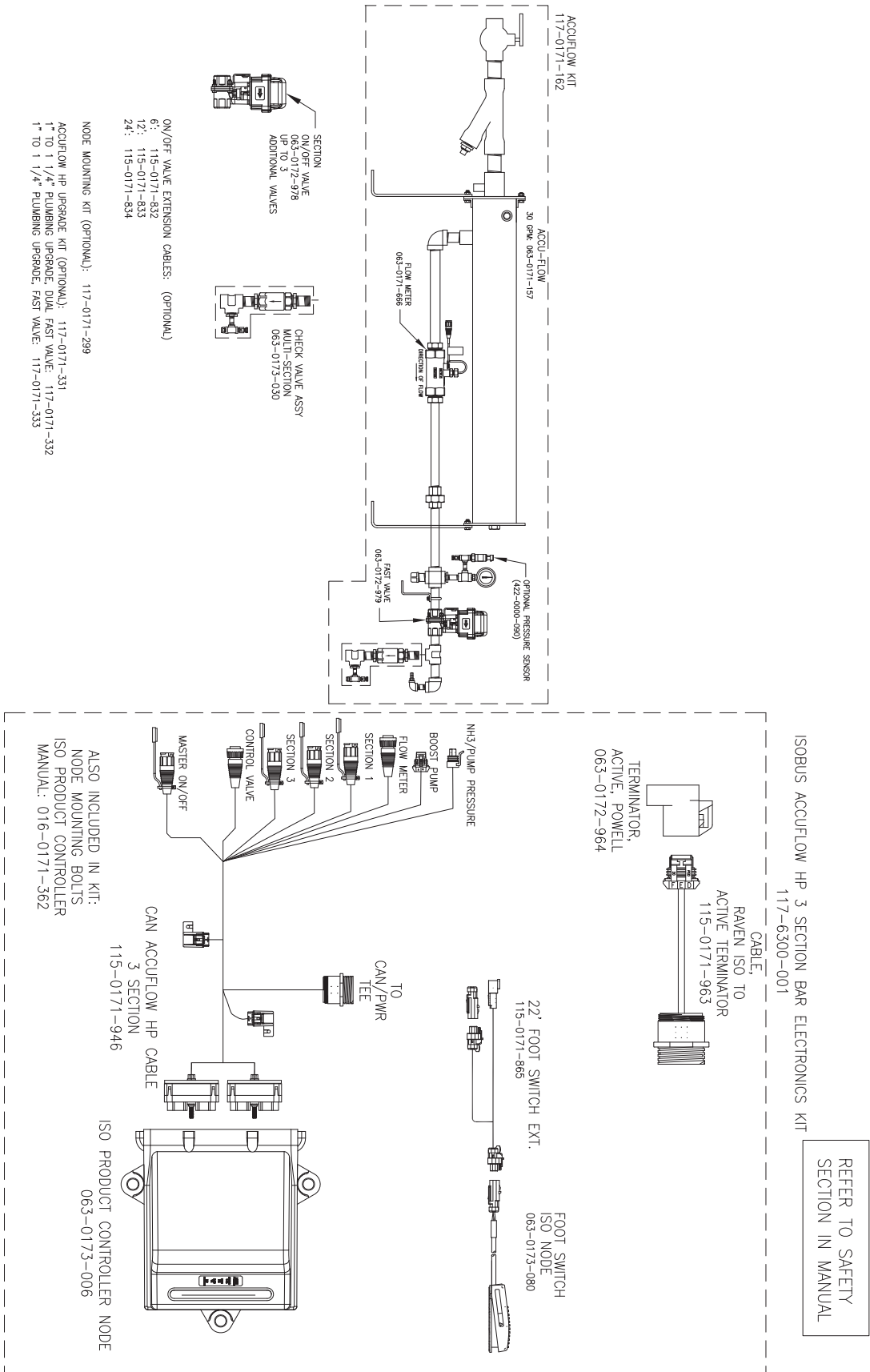

FIGURE 9. ISOBUS AccuFlow HP (6 Section Bar)

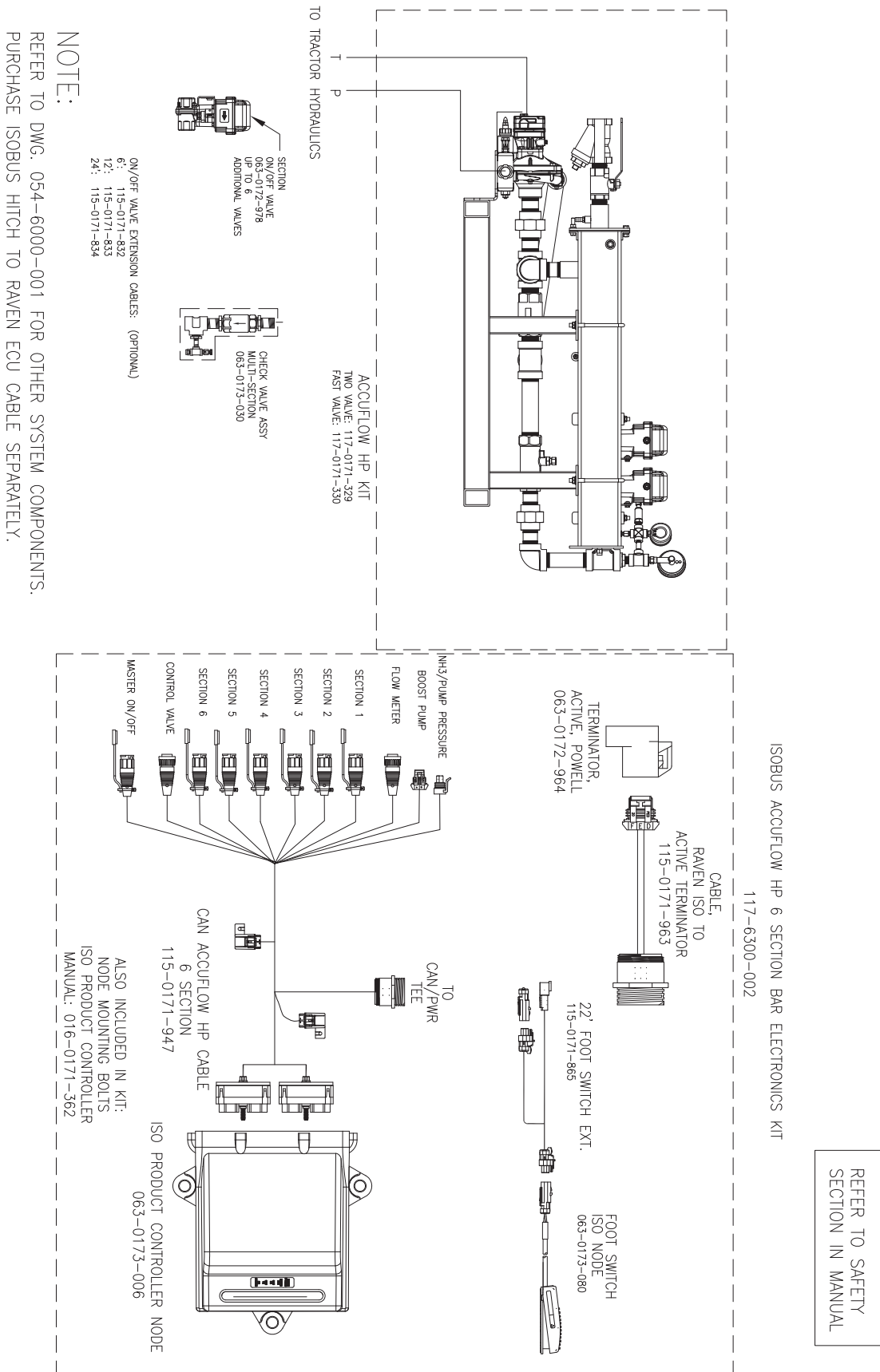
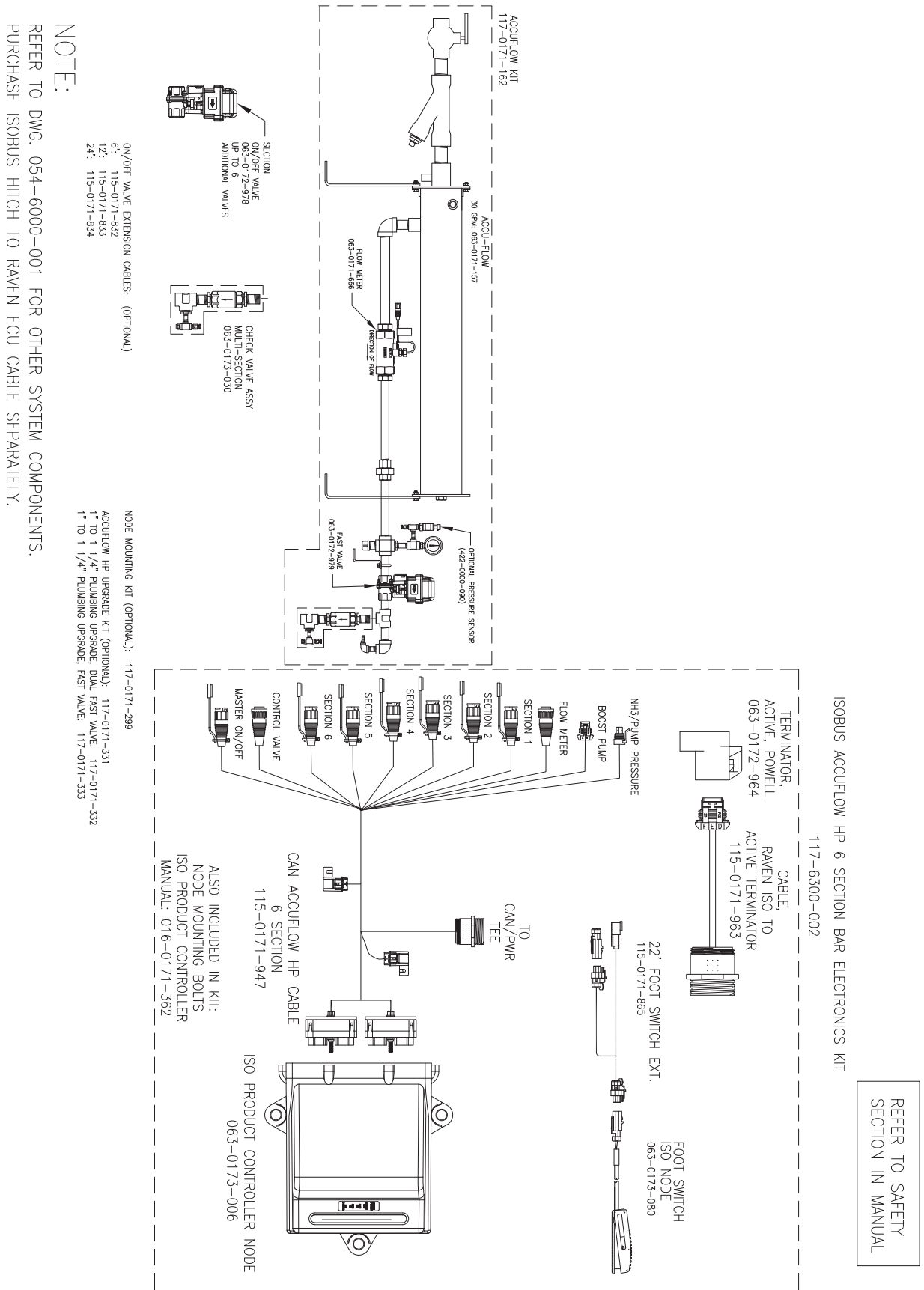

FIGURE 10. ISOBUS AccuFlow (6 Section Bar)



---

## SECTION WIDTHS

Use the following formulas to help calculate the boom or implement section widths for either broadcast or band applications.

### BROADCAST

Calculate the section width with the formula:

$$T \times S = SW$$

Where T = the number of Tips in each section, S = the Spacing between tips, and SW = the Section Width.

#### FOR EXAMPLE:

20 tips in a section with spacing of 40 inches would yield:

$$20 \times 40 = 800 = SW$$

or a Section Width of 800 inches (approximately 67 feet). Enter 800 as the width for this section.

### BAND

To calculate the adjusted applied rate for band spraying applications, use the following formula:

$$\frac{BR \times BW}{S} = AR$$

Where BR = the Broadcast Rate, BW = the Band Width, S = the Spacing between the tips, and AR = the Adjusted Rate for band spraying.

#### FOR EXAMPLE:

If the broadcast rate is 20 GPA, the band width is 14 inches, and the tip spacing is 40 inches:

$$\frac{20 \times 14}{40} = 7$$

Therefore, the adjusted rate is 7 GPA.

---

## RATE CAL

The following information must be known in order to determine which spray nozzles to use with the sprayer.

- Nominal Application Pressure \_\_\_\_\_ PSI [kpa]
- Target Application Rate \_\_\_\_\_ GPA [lit/ha]
- Target Speed \_\_\_\_\_ MPH [km/h]

- Nozzle Spacing\_\_\_\_\_ inches [cm]

From this information, calculate the volume per minute per nozzle as follows:

$$NVPM = \frac{\text{Rate} \times \text{Speed} \times NS}{5,940[60,000]}$$

where NVPM = Nozzle Volume per Minute (gallons/acre [lit/ha]), Rate = target application Rate, Speed = target Speed of application, and NS = Nozzle Spacing.

**FOR EXAMPLE:**

Application Pressure = 30 PSI, Target Application Rate = 20 GPA, Target Speed = 5.2 MPH, and Nozzle Spacing = 20 inches

$$NVPM = \frac{20 \times 5.2 \times 20}{5,940} = 0.35$$

Using the calculated nozzle volume per minute of 0.35 at an application pressure of 30, select a boom nozzle which comes closest to providing the desired output.

---

## TIERED BOOM SETTINGS

A tiered boom configuration has two or more booms stacked - one directly in front of the other - and may or may not have different sets of nozzles capable of applying different rates. Specialized plumbing, cabling, and a relay box are required to utilize a tiered boom configuration. Generally, sprayers are not set up for this feature from the factory.

The boom tiers are connected to shut-off valves, which are controlled by an ISOBus product controller. This configuration allows the machine to control a much wider range of application rates than a standard, single boom configuration.

For example, a low application rate may be applied by turning on the first tier sections only. Higher application rates may be applied by switching to the second tier booms with larger nozzles. A third and an even higher rate can be achieved by using both boom tiers in tandem.

**NOTE:** The spray tips used on a tiered boom system must be extended range tips. In addition, the volume per minute of the second tier tips should not exceed 1.5 times the volume of the first tier’s tips. The tier switching points should be set to 80% of the full flow volume for the boom tier tips.

To access the Tiered Boom Settings screen:

1. Touch the Tools Menu icon on the Home screen.
2. Select the Product Control icon from the System submenu.
3. Select the Tiered Boom Settings button on the screen.

**NOTE:** The tiered boom feature is not available in a granular control mode. Be sure that the configuration screen is set to a control channel set to control a liquid product application.

The following settings may be configured on the Tiered Boom Settings screen:

Tier 1 Max - Set the desired maximum rate applied through the first tier boom sections.

Tier 2 Max - Set the desired maximum rate applied through the second tier boom sections.

Percent Tier Disable - The Percent Tier Disable is used to determine the percentage of the maximum tier rate at which tiers are disabled as the required volume per minute decreases. Using a Percent Tier Disable value allows the control valves to adjust the target rate more quickly as the required rate decreases.

**FOR EXAMPLE:**

A machine has a tiered boom configuration with the following capacities:

- Tier 1 Capacity up to 25 GPM [94.6 L/min]
- Tier 2 Capacity up to 38 GPM [143.8 L/min]

Using the given capacities, the following values should be entered as the Tiered Boom Settings:

- Tier 1 Max. = 25 GPM [94.6 L/min] x 0.8 = 20 GPM [94.6 L/min]
- Tier 2 Max. = 38 GPM [143.8 L/min] x 0.8 = 30 GPM [143.8 L/min]

Thus, as the volume per minute increases, the following tier switching should occur:

- 10 GPM [37.8 L/min] increasing to 20 GPM [75.7 L/min] = only tier 1 enabled
- 20 GPM [75.7 L/min] increasing to 30 GPM [113.6 L/min] = only tier 2 enabled
- 30 GPM [113.6 L/min] increasing to maximum flow rate = tier 1 and tier 2 enabled

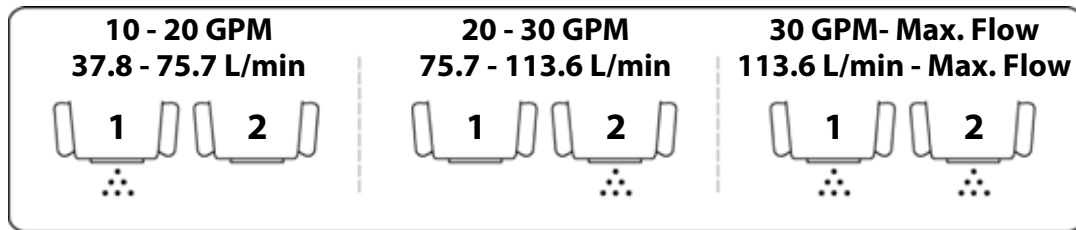

**NOTE:** Percent Tier Disable only affects tier switching when the required volume per minute is decreasing.

As rates begin to decrease from maximum, the Percent Tier Disable value is figured in. Thus, using the Tier 2 Max of 30 GPM [113.6 L/min] previously calculated and with the Percent Tier Disable set to 10%, tier 1 and 2 will switch to only tier 2 when the target rate decreases to 27 GPM [102.2 L/min].

So, for rates in gallons per minute:

$$30 \text{ GPM} - (10\% \text{ of } 30 \text{ GPM}) = 30 \text{ GPM} - 3 \text{ GPM} = 27 \text{ GPM}$$

or, for rates in liters per minute:

$$113.6 \text{ L/min} - (10\% \text{ of } 113.6 \text{ L/min}) = 113.6 \text{ L/min} - 11.3 \text{ L/min} = 102.3 \text{ L/min}$$

In operation, as the volume per minute decreases, the following boom tier switching should occur.

- Maximum flow rate decreasing to 27 GPM [102.2 L/min] = tier 1 and tier 2 enabled
- 27 GPM [102.2 L/min] decreasing to 18 GPM [68.1 L/min] = only tier 2 enabled

18 GPM [68.1 L/min] decreasing to 10 GPM [37.8 L/min] = only tier 1 enabled

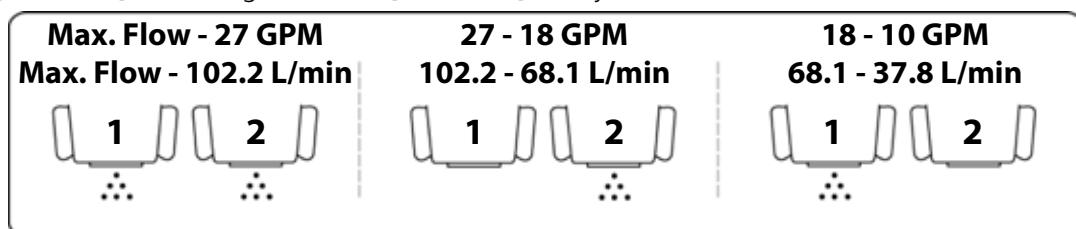

## VALVE CAL

To ensure that the proper amount of product is being applied, the valve cal must be programmed for the type of control valves connected to the ISOBUS product control system. The ISOBUS uses the valve calibration number to adjust the response time of the control valve motor to changes in the vehicle speed.

The following control valve calibration numbers are recommended for the valves listed:

Valve Name	Calibration Number
Standard Valve	2123
Fast or Fast Close Valve	743
PWM or PWM Close Valve	43

Each digit in the calibration number corresponds to a specific function of the valve. The following functions apply to the digits in the valve calibration number:

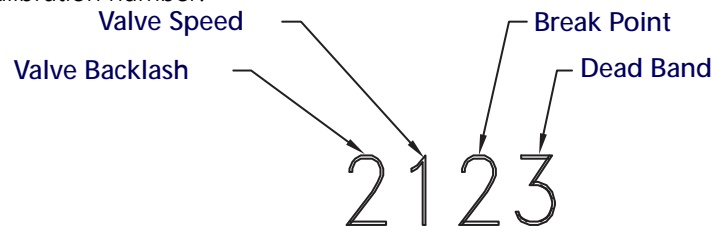

### VALVE BACKLASH DIGIT

This value controls the time of the first correction pulse after detecting a change in correction direction. The values range from 1 to 9, where 1 is for a short pulse and 9 is for a long pulse.

### VALVE SPEED DIGIT

This value controls the response time of the control valve motor. If the valve speed setting is too fast, the valve will over correct and the system can start to oscillate. The following valves have specific values:

- Standard Control Valve: This valve has a range of values from 1 to 9, with 1 being slow and 9 being fast.
- Fast and Fast Close Control Valve: These valves have a range of values from 0 to 9, with 0 for fast and 9 for slow.

### BRAKE POINT DIGIT

The brake point digit sets the percent away from the target rate at which the control valve starts to turn at a slower rate so that it does not overshoot the target rate. The values range from 0 to 9, where 0 is a 5% rate, 1 is a 10% rate, and 90 is a 90% rate.

### DEAD BAND DIGIT

The dead band digit is the allowable difference between the target rate and the actual application rate. The values range from 1 to 9, where 1 equals 1% difference and 9 equals 9% of the difference.



---

## VALVE CAL 2

**NOTE:** If the dual loop control feature is enabled, the valve cal 2 value will be replaced by the Sgain (pressure system gain) value.

When a fast close valve is selected, the valve cal 2 value is utilized to enable a high resolution rate control for lower application rates.

Enter a non-zero value for the time, in milliseconds, which the valve will be fully opened before switching into high resolution control. For example, a value of 200 will give the valve a 200 millisecond "burst" at a full 12V to open the fast valve from the closed position before resuming product rate control. A zero value will disable this feature.

## FLOW CAL (DUAL LOOP CONTROL MODE)

The flow cal value has two components which may be used to adjust the response of the application system.

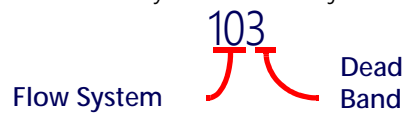

**NOTE:** It is recommended to set the Sgain value prior to making any adjustments to the flow cal value.

**Flow System Gain.** The first digit(s) of the flow cal correspond to a flow system gain between 1 and 99. The higher the flow system gain, the more aggressive the system will respond to changes in flow rate.

**NOTE:** When entering a flow gain value from 1 to 9, it is not necessary to enter a zero in front of the value.

If the system adjusts to rate control changes too slowly, increase the flow gain digit(s) to increase the system response rate. If the system overshoots or oscillates around the desired flow rate, decrease the flow gain digit(s) to help stabilize the system.

**Dead Band Digit.** The last, or right most, digit in the flow cal value is the dead band digit. The dead band digit is the allowable difference between the target rate and the actual application rate. The values range from 1 to 9, where 1 equals 1% difference and 9 equals 9% of the difference.

## SGAIN (PRESSURE SYSTEM GAIN - DUAL LOOP CONTROL MODE)

The default setting for the Sgain value is 100. To adjust the system aggressiveness, enter a value between 1 and 999 as necessary.

**NOTE:** It is recommended to increase or decrease the current value in increments of 10 or less when making adjustments to the Sgain setting. If the new value does not produce significant or notable changes in the system response, increments of 20 may be used.

Increase the Sgain value if the observed product pressure increases too slowly or if the system takes a long time to reach a set standby pressure or rate input change. If the system is consistently over shooting a set standby pressure or oscillating around a target rate, decrease the Sgain value until the system stabilizes.

## SPREADER CONSTANT

**NOTE:** The spreader constant should be verified by performing the procedure described in the Verification of Spreader Constant section on page 64.

For Gran 2 or Gran 3 applications, gate width is the total of both openings.

### STANDARD RATE DISPLAY

For rates displayed in 1 pound increments, the formula to calculate the spreader constant is:

$$SC = \frac{311,040}{L \times GH \times GW}$$

Where SC = the Spreader Constant, L = Length of belt travel in inches per 1 revolution of the encoder, GH = Gate Height in inches, GW = Gate Width in inches.

#### FOR EXAMPLE:

Given a Length of belt travel of 13 inches, a Gate Height of 7 inches, and a Gate Width of 15 inches:

$$\frac{311,040}{13 \times 7 \times 15} = 228$$

Enter 228 as the Spreader Constant if the VT display is set to display English or standard units.

### METRIC RATE DISPLAY

For Rates displayed in 1 kilogram increments, the formula to calculate the spreader constant is:

$$SC = \frac{18,000,000}{L \times GH \times GW}$$

Where SC = the Spreader Constant, L = Length of belt travel in centimeters per 1 revolution of the encoder, GH = Gate Height in centimeters, and GW = Gate Width in centimeters.

#### FOR EXAMPLE:

Given a Length of belt travel of 33 cm, a Gate Height of 18 cm, and a Gate Width of 38 cm:

$$\frac{18,000,000}{33 \times 18 \times 38} = 797$$

Enter 797 as the Spreader Constant if the VT display is set to display Metric units.

### VERIFICATION OF SPREADER CONSTANT

To verify and refine the spreader constant, perform the following procedure:

1. Weigh loaded truck and record the initial weight.

2. Select the density value on the main screen and enter the product density in lbs/ft.<sup>3</sup> [grams/liter].

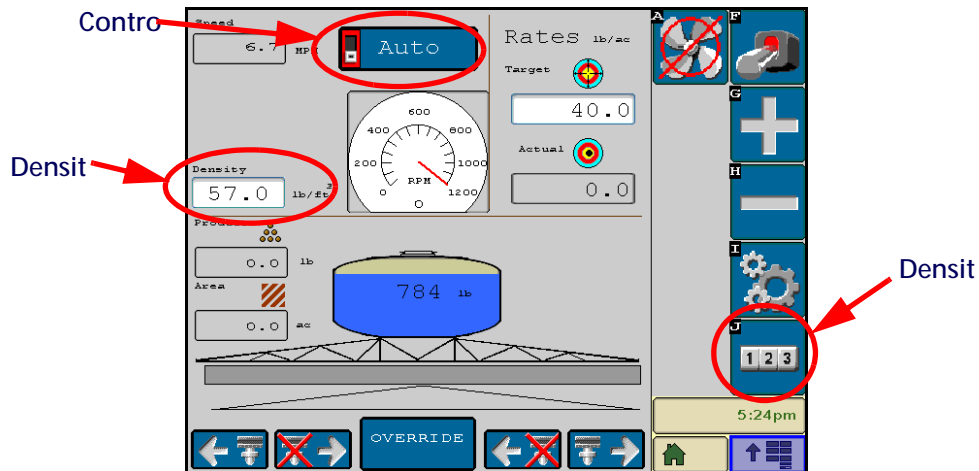

3. Select the control mode status area at the top of the main screen to toggle the control mode to manual.
4. Select the tally registers icon in the softkeys area to display the registers screen.

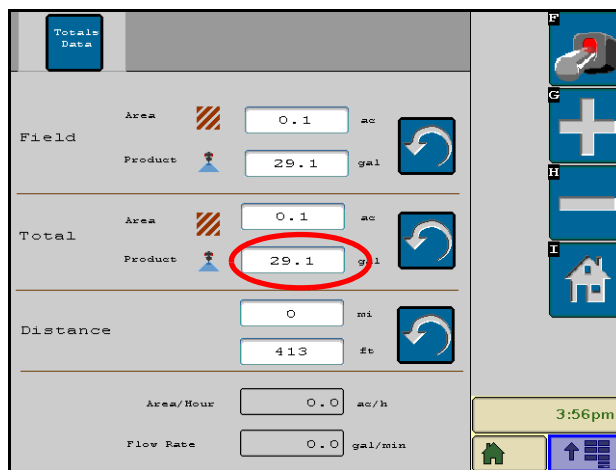

5. Reset the total volume to zero.
6. With the product node in the manual control mode, unload a portion of the load by toggling the boom switch on.
7. Determine the actual weight unloaded by re-weighing the truck.
8. Compare the actual weight unloaded to the total volume displayed on the VT display. Perform the following calculation to refine the spreader constant, if desired:

$$\frac{OSC \times TV}{AW} = CSC$$

Where OSC = the Old Spreader Constant, TV = the Total Volume, and AW = the Actual Weight unloaded and CSC = the Corrected Spreader Constant.

**FOR EXAMPLE:**

Using an Old Spreader Constant = 228 [797], Total Volume = 2000 lbs [4400 kg], and an Actual Weight Unloaded = 1950 lbs [4290 kg]:

**ENGLISH:**

$$\frac{228 \times 2000}{1950} = 234$$

The new spreader constant value should be entered as 234.

METRIC:

$$\frac{797 \times 4400}{4290} = 817$$

The new spreader constant value should be entered as 817

9. Repeat this procedure until the weight of the metered materials equals the total volume reported by the VT display.

---

## SPINNER RPM

For spinner box machines, using the optional spinner speed cable (P/N 115-0171-880) to control spinner speed.

## VALVE TYPE

Select the valve type of the machine with which the Raven ISOBUS product control node is currently connected to the spinner.

---

## RPM METER CAL

The machine should be configured with a magnetic pickup coil mounted near the bolt heads on the spinner. Calculate the meter cal by multiplying the number of pulses (bolt heads) per revolution by 10.

$$\text{MeterCal} = N \times 10$$

### FOR EXAMPLE:

If the number of pulses per revolution is 4:

$$4 \times 10 = 40$$

then the value for the Meter Cal would be 40.

## RPM TARGET

The Rate Cal should be set to the desired RPM of the spinner.



# FLOW METER MAINTENANCE AND ADJUSTMENT PROCEDURE

## FLOW METER MAINTENANCE

**NOTE:** Thoroughly bleed nurse tank hose and all other system lines prior to disassembling the flow meter, fittings, or hoses.

1. Remove flow meter from the vehicle and flush with clean water to remove any chemicals.
2. Remove flange bolts or clamp from the flow meter.
3. Remove the turbine hub and turbine from inside flow meter.
4. Clean turbine and turbine hub of metal filings or any other foreign material, such as wettable powders. Confirm that the turbine blades are not worn. While holding the turbine hub in your hand, spin turbine. The turbine should spin freely with very little drag inside the hub.
5. If transducer assembly is replaced or if turbine stud is adjusted or replaced, verify the turbine fit before reassembling. Hold turbine hub with turbine on transducer. Spin turbine by blowing on it. Tighten turbine stud until turbine stalls. Loosen turbine stud 1/3 turn. The turbine should spin freely.
6. Re-assemble flow meter.
7. Using a low pressure (5 psi) [34.5 kPa] jet of air, verify the turbine spins freely. If there is drag, loosen hex stud on the bottom of turbine hub 1/16 turn until the turbine spins freely.
8. If the turbine spins freely and cables have been checked per Testing Flow Meter Cables section on page 71, but flow meter still is not metering properly, replace flow meter transducer.

## TESTING FLOW METER CABLES

Disconnect the extension cable from the flow meter. Hold the flow meter cable so that the keyway is pointing in the 12 o'clock position.

**FIGURE 1. Flow Meter Extension Cable Pin Diagram**

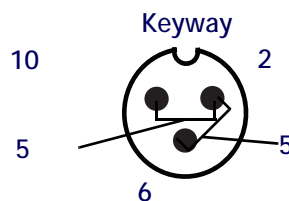

## TESTING THE FLOW METER/ENCODER CABLE

1. From the main Raven ISOBUS control screen, select the tools icon from the softkeys area to access the ISOBUS control node configuration screens.

2. Enter a meter cal of 1 in liquid or direct injection modes, or density of 1 and spreader constant of 0 in granular mode, in the Raven ISOBUS product control screens.
3. From the main Raven product control screen, select the "Tally Registers" icon from the softkeys area to display the total volume tally. Monitor the total volume applied screen while testing the cable
4. Place boom and master switches in the ON position.
5. Use a small jumper wire or paper clip to short the 2 o'clock and 6 o'clock sockets with a "short-no short" motion. Each time the short is made, the total volume reading should increase by increments of 1 or more.
6. If the distance does not increase, disconnect this section of cable and repeat this test at the next connector closest to node. Replace defective cable as required and test the flow meter cable voltage as previously described.
7. If all cables test good, replace the flow meter or encoder.

**NOTE:** After testing is complete, re-enter correct meter cal numbers.

---

## PROCEDURE TO RECALIBRATE FLOW METER

1. From the Raven ISOBUS main screen, select the tools icon from the softkeys area.
2. Enter a value of 10 [38] for the meter cal value.
3. Return to the Raven ISOBUS main screen and select the tally registers icon from the softkeys area.
4. Enter a value of 0 for the total volume value.
5. Place the master switch and all boom sections in the OFF position.
6. Remove a boom hose and place it into a calibrated 5 gallon [19 liter] container.
7. Toggle the master switch and the boom switch corresponding to the hose that was placed in the container. Pump exactly 10 gallons [38 liters].
8. Check the total volume registered on the display. The reading displayed is the new meter cal value. This value should be within +/- 3% of the calibration number stamped on the tag of the flow meter.
9. Repeat this procedure several times to confirm accuracy (Always "zero out" the total volume display before retesting).

**NOTE:** For greatest precision, set meter cal to 100 [378] and pump 100 gallons (378 liters) of water.

10. To verify the flow meter calibration, the fill applicator tank with a predetermined amount of measured liquid (i.e. 250 gallons).

**NOTE:** Do not rely on graduation marks molded into the applicator tank.

11. Empty the applicator tank under normal operating conditions.  
If the total volume displayed is different from the predetermined amount of measured liquid by more than +/- 3%, complete the following calculation:

$$CMC = \frac{MC \times V_M}{V_A}$$

Where CMC = the Corrected Meter Cal, MC = the Meter Cal used to apply the known volume, and VM = the Volume that the VT measured, and VA = the predetermined volume applied.

### FOR EXAMPLE:

The VT displays a Total Volume of 260 [984] when a Meter Cal of 720 [190] was used to apply a measured volume of 250 gallons [946 liters]. Therefore:

$$CMC = \frac{720 \times 260}{250} = 749$$



---

or

$$CMC = \frac{[190] \times [984]}{[946]} = [198]$$

the Corrected Meter Cal is 749 [198]

12. Press METER CAL and enter the Corrected Meter Cal value before resuming application.



## C

**Calibration** 15**Calibration Screen** 16

- Alarms Setup Tab 34
  - Bin Level Sensor 35
  - Dual Encoder Error Percent 35
  - Low Limit 34
  - Low Tank 34
  - Off Rate Percent 35
  - RPM Off Rate Percent 35
- Implement Calibration
  - Applicator Type 17
  - Section Setup 18
  - Total Width Display 17
- Implement Calibration Tab 17
- Product Control Calibration Tab 19
  - Control Type 20
  - Feature Settings 31
  - Meter Cal or Spreader Constant 20
  - Pulse Width Modulation Valves 27
  - Self Test Speed 21
  - Spinner/Fan Control Setup 24
  - Tank or Bin Capacity 21
  - Valve Cal 22
  - Valve Delay 21

**Calibration Values**

- Calculating 61
- Rate Cal 61
- Section Widths 61
- Spinner RPM 68
- Spreader Constant 66
- Valve Cal 64

## E

**Edit Mode** vi

## F

**Flow Meter Maintenance and Adjustment Procedure** 71

## H

**Home Screen** 37

- Application Speed 39
- Area Covered 44
- Control Mode (Auto/Manual) 39
- Pressure or Spinner/Fan RPM Display 41
- Product Density (Granular Applications) 40
- Rates Area 42
- Remaining Tank/Bin Volume 43
- Remote Master (Switch) Status 39
- Section Status Display 45
- Target Pressure (NH<sub>3</sub> Applications) 40
- Volume Applied 43

## I

**Important Safety Information** 1

- Electrical Safety 1

**Installation** 9

- Cabling 13

- Control Valve 10
- Flow Meter 9
- Mount the Foot Switch 13
- Node 11

**Introduction**

- Unit Definitions and Conversions vi
- Unit of Measure Conversions vi
- Unit of Measure Definitions vi

**ISOBUS Product Control Node Kits** 5

## M

**Manual Section Controls** 45

## O

**Operation** 37

## P

**Product Control Home Screen** 37

## S

**System Diagrams** 51

- ISOBUS Granular Product Control System (22-pin Product Cable) 56
- ISOBUS Granular Product Control System (37-pin Product Cable) 53
- ISOBUS Liquid Product Control System (16-pin Product Cable) 52
- ISOBUS Liquid Product Control System (22-pin Product Cable) 55
- ISOBUS Liquid Product Control System (37-pin Product Cable) 54
- ISOBUS Trunk Line Cabling 51

## T

**Tally Registers** 47

- Area per Hour Display 48
- Distance 48
- Field Area and Volume 48
- Total Area and Volume 48
- Volume per Minute Display 48

**Testing Extension Cables**

- Flow Meter Cables 71

## U

**Updates** 6



# RAVEN

## Limited Warranty

---

### ***What Does this Warranty Cover?***

This warranty covers all defects in workmanship or materials in your Raven Applied Technology Division product under normal use, maintenance, and service when used for intended purpose.

### ***How Long is the Coverage Period?***

Raven Applied Technology products are covered by this warranty for 12 months from the date of retail sale. In no case will the Limited Warranty period exceed 24 months from the date the product was issued by Raven Industries Applied Technology Division. This warranty coverage applies only to the original owner and is non-transferable.

### ***How Can I Get Service?***

Bring the defective part and proof of purchase to your Raven dealer. If the dealer approves the warranty claim, the dealer will process the claim and send it to Raven Industries for final approval. The freight cost to Raven Industries will be the customer's responsibility. The Return Materials Authorization (RMA) number must appear on the box and all documentation (including proof of purchase) must be included inside the box to be sent to Raven Industries.

### ***What Will Raven Industries Do?***

Upon confirmation of the warranty claim, Raven Industries will (at our discretion) repair or replace the defective product and pay for the standard return freight, regardless of the inbound shipping method. Expedited freight is available at the customer's expense.

### ***What is not Covered by this Warranty?***

Raven Industries will not assume any expense or liability for repairs made outside our facilities without written consent. Raven Industries is not responsible for damage to any associated equipment or products and will not be liable for loss of profit, labor, or other damages. The obligation of this warranty is in lieu of all other warranties, expressed or implied, and no person or organization is authorized to assume any liability for Raven Industries.

**Damages caused by normal wear and tear, misuse, abuse, neglect, accident, or improper installation and maintenance are not covered by this warranty.**



## Extended Warranty

### ***What Does this Warranty Cover?***

This warranty covers all defects in workmanship or materials in your Raven Applied Technology Division product under normal use, maintenance, and service when used for intended purpose.

### ***Do I Need to Register My Product to Qualify for the Extended Warranty?***

Yes. Products/systems must be registered within 30 days of retail sale to receive coverage under the Extended Warranty. If the component does not have a serial tag, the kit it came in must be registered instead.

### ***Where Can I Register My Product for the Extended Warranty?***

To register, go online to [www.ravenhelp.com](http://www.ravenhelp.com) and select Product Registration.

### ***How Long is the Extended Warranty Coverage Period?***

Raven Applied Technology products that have been registered online are covered for an additional 12 months beyond the Limited Warranty for a total coverage period of 24 months from the date of retail sale. In no case will the Extended Warranty period exceed 36 months from the date the product was issued by Raven Industries Applied Technology Division. This Extended Warranty coverage applies only to the original owner and is non-transferable.

### ***How Can I Get Service?***

Bring the defective part and proof of purchase to your Raven dealer. If the dealer approves the warranty claim, the dealer will process the claim and send it to Raven Industries for final approval. The freight cost to Raven Industries will be the customer's responsibility. The Return Materials Authorization (RMA) number must appear on the box and all documentation (including proof of purchase) must be included inside the box to be sent to Raven Industries. In addition, the words "Extended Warranty" must appear on the box and all documentation if the failure is between 12 and 24 months from the retail sale.

### ***What Will Raven Industries Do?***

Upon confirmation of the product's registration for the Extended Warranty and the claim itself, Raven Industries will (at our discretion) repair or replace the defective product and pay for the standard return freight, regardless of the inbound shipping method. Expedited freight is available at the customer's expense.

### ***What is Not Covered by the Extended Warranty?***

Raven Industries will not assume any expense or liability for repairs made outside our facilities without written consent. Raven Industries is not responsible for damage to any associated equipment or products and will not be liable for loss of profit, labor, or other damages. Cables, hoses, software enhancements, and remanufactured items are not covered by this Extended Warranty. The obligation of this warranty is in lieu of all other warranties, expressed or implied, and no person or organization is authorized to assume any liability for Raven Industries.

**Damages caused by normal wear and tear, misuse, abuse, neglect, accident, or improper installation and maintenance are not covered by this warranty.**