

**AccuFlow Vortex Installation Manual:
John Deere 2410 C**

Manual No. 016-0171-591 Rev. C 04/16 E27648

Disclaimer

While every effort has been made to ensure the accuracy of this document, Raven Industries assumes no responsibility for omissions and errors. Nor is any liability assumed for damages resulting from the use of information contained herein.

Raven Industries shall not be responsible or liable for incidental or consequential damages or a loss of anticipated benefits or profits, work stoppage or loss, or impairment of data arising out of the use, or inability to use, this system or any of its components. Raven Industries shall not be held responsible for any modifications or repairs made outside our facilities, nor damages resulting from inadequate maintenance of this system.

As with all wireless and satellite signals, several factors may affect the availability and accuracy of wireless and satellite navigation and correction services (e.g. GPS, GNSS, SBAS, etc.). Therefore, Raven Industries cannot guarantee the accuracy, integrity, continuity, or availability of these services and cannot guarantee the ability to use Raven systems, or products used as components of systems, which rely upon the reception of these signals or availability of these services. Raven Industries accepts no responsibility for the use of any of these signals or services for other than the stated purpose.

Chapter 1	<i>Important Safety Information</i>	1
	Instructions for Wire Routing	5
	Instructions for Hose Routing	6
Chapter 2	<i>Introduction</i>	9
	Introduction	9
	Point of Reference	9
	Required Tools and Supplies	9
	Kit Contents	9
	JDB-PF11-005 Parts	10
	JDB-PF11-006 Parts	14
	Updates	20
Chapter 3	<i>AccuFlow™ Vortex Cooler Assembly</i>	21
	Assembly Overview	21
	Inlet Manifold Assembly	21
	Outlet Assembly	22
	Leak Test	23
	Vapor Port Assembly	24
Chapter 4	<i>Mounting</i>	25
	Installing Toolbar Mounting Brackets	25
	Attaching Cooler to Mounting Brackets	26
	AccuDepth Bracket Installation	27
Chapter 5	<i>Section Valve and Impellicone Assembly</i>	29
	Impellicone Assembly	29
	Mounting the Impellicone to the Toolbar	30
	Cable Harness Connection	31
	GreenStar™ Rate Controller Installation	32
Chapter 6	<i>Hose & Supply Line Installation</i>	33
	Routing Hose Between Cooler and Section Valves	33
	Supply Line Installation	34
	Applicator Line Installation	35
	Vapor Line Installation	35
	Bleed Line Hose Routing	36
	Emergency Shut-off Rope Installation	37

Chapter 7 *Replacement Parts* 39
 Replacement Parts 39

CHAPTER

1

*Important Safety
Information*

NOTICE

- Read this manual carefully before installing the AccuFlow™ Vortex system.
- Review procedures for safe handling and use of anhydrous ammonia (NH₃) with your NH₃ supplier. If you are not trained to handle anhydrous ammonia, contact your NH₃ supplier or the appropriate agricultural department for information on training.
- Please review the operation and safety instructions included with your implement and/or controller.
- Follow safety information presented within this manual and review operation of the AccuFlow Vortex system with your NH₃ supplier.
- Follow all safety labels affixed to the AccuFlow Vortex system components. Be sure to keep safety labels in good condition and replace any missing or damaged labels. To obtain replacements for missing or damaged safety labels, contact your local Raven dealer.
- Do not attempt to modify or lengthen any of the system control cables. Extension cables are available from your local John Deere dealer.
- If you require assistance with any portion of the installation or service of your John Deere equipment, contact your local John Deere dealer for support.

⚠ DANGER

1. Anhydrous Ammonia (NH₃) Under Pressure. Anhydrous ammonia can cause severe burning, blindness, or death. Carefully read and follow all safety instructions and warnings before operating or servicing equipment. Review safety requirements associated with NH₃ and the AccuFlow Vortex™ manual with your NH₃ supplier.
2. Always wear proper personal protective equipment when working with the AccuFlow Vortex system and anhydrous ammonia. Appropriate protective clothing includes, but is not limited to:
 - Goggles or Face Shield
 - Protective Suit and Gloves
 - Respirator
3. Do not allow any one to operate the AccuFlow Vortex system without proper instruction and training.

FIGURE 1. Danger and Caution Warning Decal Affixed to AccuFlow Vortex Cooler (P/N 039-0159-066)

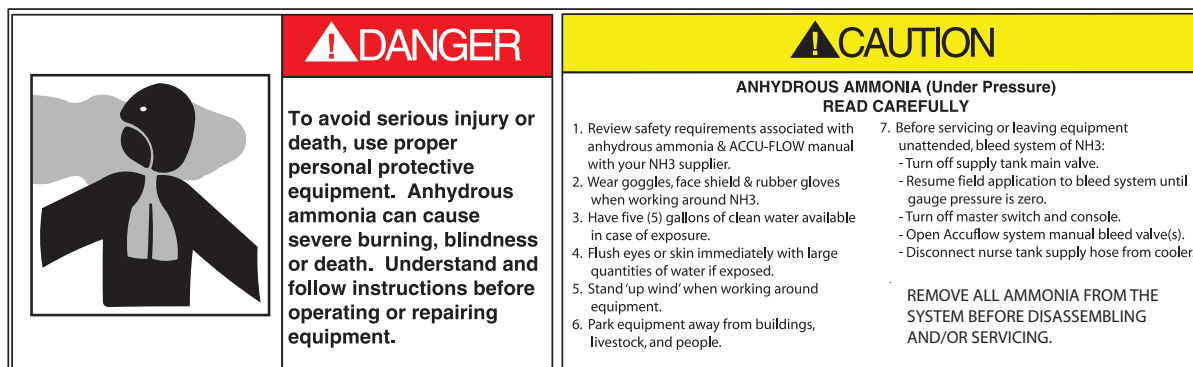

 **CAUTION**

1. Use caution when handling anhydrous ammonia (NH₃) products.
 - a. Stand 'up wind' when working around anhydrous ammonia (NH₃) and related equipment. Always keep anhydrous ammonia equipment away from buildings, livestock, and other people.
 - b. Anhydrous ammonia may cause sickness or death. Never work on NH₃ equipment in confined spaces. Seek immediate medical attention if symptoms of illness occur during, or shortly after, use of anhydrous ammonia products.
 - c. Keep a source of clean water (at least five gallons) readily available while working with anhydrous ammonia. In case of exposure, flush exposed skin or eyes immediately with large quantities of water and seek immediate medical attention.
 - d. NH₃ can be harmful to the environment if not used properly. Follow all local, state, and federal regulations regarding proper handling of anhydrous ammonia.
2. Always remove the AccuFlow Vortex system from NH₃ service before performing maintenance.
 - a. Thoroughly bleed all system lines and disconnect nurse tank hose before beginning service or maintenance.
 - b. Remove all ammonia from the system before disassembling or servicing.
3. Use extreme caution when opening a previously pressurized system.
4. Before performing service or maintenance on the AccuFlow Vortex system, read and follow the instructions provided in the AccuFlow Vortex Installation Manual to properly discharge anhydrous ammonia.

Read this manual and the operation and safety instructions included with the implement and/or controller carefully.

- Follow all safety information presented within this manual.
- Contact a local Raven dealer for support for additional assistance or support with any portion of the installation or service of Raven equipment.
- Follow all safety labels affixed to the system components. Keep safety labels in good condition and replace any missing or damaged labels. Contact a local Raven dealer to obtain replacements for missing or damaged safety labels.

When operating the machine, observe the following safety measures:

- Be alert and aware of surroundings.
- Do not operate the device while under the influence of alcohol or illegal substances.
- Ensure the device is disabled prior to starting maintenance work on the machine.
- Follow all label instructions for proper chemical mixing, handling, and container disposal methods.
- Review procedures for safe handling and use of agricultural chemicals and products with a chemical supplier. Contact a local chemical supplier, or the appropriate agricultural department, for information on obtaining the necessary training.
- Do not attempt to modify or lengthen any of the system cables. Contact a local John Deere dealer for available extension cables.

 **DANGER**

Agricultural Chemical Safety

- Always follow safety labels and instructions provided by the chemical manufacturer or supplier.
- Always wear appropriate personal protective equipment as recommended by the chemical and/or equipment manufacturer.
- When storing unused agricultural chemicals:
 - Keep chemicals in the original container and do not transfer chemicals to unmarked containers or containers used for food or drink.
 - Keep chemicals in a secure, locked area away from human and livestock food.
 - Keep children away from storage areas.
- Fill, flush, calibrate, and decontaminate chemical application systems in an area where runoff will not reach ponds, lakes, streams, livestock areas, gardens, or populated areas.
- Avoid inhaling chemical dust or spray particulate and avoid direct contact with agricultural chemicals. Seek immediate medical attention if symptoms of illness occur during, or soon after, use of agricultural chemicals, products, or equipment.
- After handling or applying agricultural chemicals:
 - Thoroughly wash hands and face after using agricultural chemicals and before eating, drinking, or using the rest room.
 - Thoroughly flush or rinse equipment used to mix, transfer, or apply chemicals with water after use or before servicing any component of the application system.
- Follow all federal, state, and local regulations regarding the handling, use, and disposal of agricultural chemicals, products, and containers. Triple-rinse and puncture or crush empty containers before disposing of them properly. Contact a local environmental agency or recycling center for additional information.

 **CAUTION****Hydraulic Safety**

- Wear appropriate personal protective equipment at all times when working on a hydraulic system.
- Never attempt to open or work on a hydraulic system with the equipment running. Always be careful when opening a system that has been previously pressurized.
- Hydraulic fluid may be extremely hot and under high pressure. Exercise caution when disconnecting or servicing hydraulic systems, even if the system has not been in use recently.
- Any work performed on the hydraulic system must be done in accordance with the machine manufacturer's approved maintenance instructions.
- When installing hydraulics or performing diagnostics, maintenance, or routine service, ensure precautions are taken to prevent foreign material or contaminants from being introduced into the machine's hydraulic system. Objects or materials that are able to bypass the machine's hydraulic filtration system will reduce performance and may damage valves.

Electrical Safety

- Always verify that the power leads are connected to the correct polarity as marked. Reversing the power leads could cause severe damage to the equipment.
- Always connect the power cable last.
- Remove rings and other jewelry to prevent electrical shorts or entanglement in moving parts.

Instructions for Wire Routing

The word harness is used to mean all electrical leads and cables, bundled and unbundled. When installing harness, secure it at least every 30 cm (12in) to the frame. Follow existing harness as much as possible and use these guidelines:

Harness should not contact or be attached to:

- Lines and hoses with high vibration forces or pressure spikes
- Lines and hoses carrying hot fluids beyond harness component specifications

Avoid contact with any sharp edge or abrading surfaces such as, but not limited to:

- Sheared or flame cut edges
- Edges of machined surfaces
- Fastener threads or cap screw heads
- Ends of adjustable hose clamps
- Wire exiting conduit without protection, either ends or side of conduit
- Hose and tube fittings

Routing should not allow harnesses to:

- Hang below the unit
- Have the potential to become damaged due to exposure to the exterior environment. (i.e. tree limbs, debris, attachments)
- Be placed in areas of or in contact with machine components which develop temperatures higher than the temperature rating of harness components
- Wiring should be protected or shielded if it needs to route near hot temperatures beyond harness component specifications

Harnessing should not have sharp bends

Allow sufficient clearance from machine component operational zones such as:

- Drive shafts, universal joints and hitches (i.e. 3-point hitch)
- Pulleys, gears, sprockets
- Deflection and backlash of belts and chains
- Adjustment zones of adjustable brackets
- Changes of position in steering and suspension systems
- Moving linkages, cylinders, articulation joints, attachments
- Ground engaging components

For harness sections that move during machine operation:

- Allow sufficient length for free movement without interference to prevent: pulling, pinching, catching or rubbing, especially in articulation and pivot points
- Clamp harnesses securely to force controlled movement to occur in the desired harness section
- Avoid sharp twisting or flexing of harnesses in short distances
- Connectors and splices should not be located in harness sections that move

Protect harnesses from:

- Foreign objects such as rocks that may fall or be thrown by the unit
- Buildup of dirt, mud, snow, ice, submersion in water and oil
- Tree limbs, brush and debris
- Damage where service personnel or operators might step or use as a grab bar
- Damage when passing through metal structures
- High pressure wash

Instructions for Hose Routing

The word hoses is used to mean all flexible fluid carrying components. Follow existing hoses as much as possible and use these guidelines:

Hoses should not contact or be attached to:

- Components with high vibration forces
- Components carrying hot fluids beyond hoses component specifications

Avoid contact with any sharp edge or abrading surfaces such as, but not limited to:

- Sheared or flame cut edges
- Edges of machined surfaces
- Fastener threads or cap screw heads
- Ends of adjustable hose clamps

Routing should not allow hoses to:

- Hang below the unit
- Have the potential to become damaged due to exposure to the exterior environment. (i.e. tree limbs, debris, attachments)
- Be placed in areas of or in contact with machine components which develop temperatures higher than the temperature rating of hose components
- Hoses should be protected or shielded if it needs to route near hot temperatures beyond hose component specifications

Hoses should not have sharp bends

Allow sufficient clearance from machine component operational zones such as:

- Drive shafts, universal joints and hitches (i.e. 3-point hitch)
- Pulleys, gears, sprockets
- Deflection and backlash of belts and chains
- Adjustment zones of adjustable brackets
- Changes of position in steering and suspension systems
- Moving linkages, cylinders, articulation joints, attachments
- Ground engaging components

For hose sections that move during machine operation:

- Allow sufficient length for free movement without interference to prevent: pulling, pinching, catching or rubbing, especially in articulation and pivot points
- Clamp hoses securely to force controlled movement to occur in the desired hose section
- Avoid sharp twisting or flexing of hoses in short distances

Protect hoses from:

- Foreign objects such as rocks that may fall or be thrown by the unit
- Buildup of dirt, mud, snow, ice, submersion in water and oil
- Tree limbs, brush and debris
- Damage where service personnel or operators might step or use as a grab bar
- Damage when passing through metal structures
- High pressure wash

Introduction

Point of Reference

All references to left, right, front, or back are made assuming you are standing at the back of the implement looking toward the vehicle hitch.

Required Tools and Supplies

- Pipe wrenches (must accommodate 2" minimum pipe size)
- SAE and Metric combination wrenches
- SAE and Metric deep well sockets and socket wrench
- Lifting device rated at 350 lbs. [160 kg]

Kit Contents

This sections contains tables that show images of the parts included in each kit shipped with the AccuFlow™ Vortex cooler. The images included in the tables are not to scale and are for reference purposes only.

JDB-PF11-005 Parts

TABLE 1. Kit Parts

Item Image	Part Description	Part Number	Quantity
	Strainer, Y Type, 2" W/ Magnets	063-0173-655	2
	Valve Assembly, 2", NH3, Vented Index	063-0173-688	1
	Back Check Valve W/ Hydrostat	063-0173-691	1
	Back Check Valve W/ Bleed Valve	063-0173-692	2
	Vortex Assembly, Dual Valve, No Pump	063-0173-714	1
	Weldment, Inlet Manifold, Reverse	116-0159-755	1
No Image	Hose, 12', 1/2", NH3	214-0001-049	1
No Image	Sealant, Pipe Thread, 4 Oz Can	222-1001-088	1

TABLE 1. Kit Parts

Item Image	Part Description	Part Number	Quantity
	Bolt, 5/16" - 18 UNC x 1" Hex	311-0052-080	2
	Nut, Flange, Lock, 5/16" - 18, Zinc	312-1001-169	2
No Image	Rope, Poly Braided, 1/4" D	321-0000-359	1
No Image	Teflon Tape	332-0000-038	2
	Fitting, 1" NPT x 3/4" HB	333-0002-305	4
	Fitting, 90 Degree, 1" NPT, 3/8" HB	333-0002-306	2
	Fitting, Barb Tube, 1/4" NPT, 3/8" HB	333-0002-904	1
	Coupling, 1/2" x 1/4"	333-0002-905	1
	Fitting, Reducer, 1.5" x 1.25"	333-0003-096	1



TABLE 1. Kit Parts

Item Image	Part Description	Part Number	Quantity
	Fitting, Reducer, 2" x 1.5"	333-0003-097	2
	Fitting, Tee, 3/8" Hose Barb	333-0004-037	1
	Fitting, Cross, 1" NPT, 150	333-0004-046	2
	Nipple, Pipe, 1" x 2", SCH 80	333-0008-500	2
	Nipple, 1-1/4" x Close	333-0008-499	1
	FTG, Pipe Nipple, SCH80, 2" x 3" LG	333-0008-502	3

TABLE 1. Kit Parts

Item Image	Part Description	Part Number	Quantity
	FTG, 1.5" x Close Nipple, SCH 80	333-0008-491	3
	Fitting, Plug, 1" NPT	333-0009-065	2
	Bleed Valve	334-0001-012	4
	Needle Valve, 1/4" NPT	334-0001-064	1
	Valve, Relief, 1/4" NPT	334-0002-005	3
	Clamp, Worm Drive, Hose 1/2"	435-3003-002	6

TABLE 1. Kit Parts

Item Image	Part Description	Part Number	Quantity
	Clamp, Worm Drive, Hose, 3/4"	435-3003-003	12
	Clamping U-bolt, 2-1/2"	435-3003-062	2

JDB-PF11-006 Parts

TABLE 2. Installation Hardware



Item Image	Part Description	Part Number	Quantity
	Valve, On/Off, 1" Ball, NH3	063-0172-978	3
	U-bolt, 4" W x 5" L x 3/8"	107-0171-606	7

TABLE 2. Installation Hardware

Item Image	Part Description	Part Number	Quantity
	Bracket, Impellicone Mount	107-0171-915	3
	Bracket, Mounting, Valve, HP AccuFlow	107-0171-931	1
	Bracket, Support, Inlet Manifold	107-0172-327	1
	Bracket, Cooler Support, Left	107-0172-328	1
	Bracket, Cooler Support, Right	107-0172-329	1

TABLE 2. Installation Hardware

Item Image	Part Description	Part Number	Quantity
	U-bolt, 4-1/32" W x 5-1/4" L x 5/8"	107-0172-331	3
No Image	Cable, Ext, 12", NH3, On/Off Valve	115-0171-833	1
No Image	Cable, 24' Extension, NH3 On/Off Valve	115-0171-834	2
No Image	Cable, 12' SCS 4400, 3 Section Master	115-0171-837	1
	Clamp, Worm Drive, Hose 1/2"	135-3003-002	50
No Image	Tubing, EVA, 3/8" ID	214-0001-002	15'
No Image	Hose Supply, 10', 1-1/2", NH3	214-0001-048	2
No Image	Hose Supply, 22', 1", NH3	214-0001-050	3
	Bolt, Hex Head 3/8" - 16 UNC-2A, 1-1/4" LG	311-0054-081	29
	Bolt, 5/8" - 11 x 1-1/2" Hex Head	311-0060-087	4
	Nut, Flange, Lock, 3/8"-16, Zinc	312-1001-164	43
	Nut, Flange, Lock, 5/8"-11 Unc, Zinc	312-1001-179	10
	Fitting, 1" Swivel	333-0001-030	6

TABLE 2. Installation Hardware

Item Image	Part Description	Part Number	Quantity
	Fitting, 1-1/2" Swivel	333-0001-031	2
	Impellicone, IP-1300, John Blue	333-0002-245	3
	Impellicone Splitter	333-0002-301	1
	Coupler, Breakaway, 1-1/2" NH3	333-0002-307	2
	Fitting, Barb Tube, 1/4" NPT, 3/8" HB	333-0002-904	24
	Fitting, 90 Degree Elbow, 1" FNPT, 3000	333-0005-074	3

TABLE 2. Installation Hardware

Item Image	Part Description	Part Number	Quantity
	Nipple, Pipe, 1" x 2", SCH 80	333-0008-500	3
	Nipple, Pipe, 1" x 8"	333-0008-501	3
	Fitting, Plug, Pipe, 1/4" NPT, SQ HD	333-0009-072	15
	Plug, Pipe, Male Square Head, 1" - 1 1/2"	333-0009-076	1
	Clamp, Cable, 49.3 mm, Insulated	435-3001-050	2
	Clevis, 101.6 mm Square	435-3001-051	11
	Clevis, 50.8 x 152.4 mm	435-3001-052	16

TABLE 2. Installation Hardware

Item Image	Part Description	Part Number	Quantity
	Clamp, Cable, Double 19 mm, Insulated	435-3001-053	16
	Clamp, Cable, 64 mm, Insulated	435-3001-054	3
	Clamp, Cable, Double 35 mm, Insulated	435-3001-055	11
	Clamping U-Bolt, 1-5/8"	435-3003-030	6
	Clamping U-Bolt, 1-1/4"	435-3003-056	1

Updates

Updates for Raven manuals as well as software updates for Raven consoles are available at the Raven Applied Technology Division web site:

www.ravenhelp.com

At Raven Industries, we strive to make your experience with our products as rewarding as possible. One way to improve this experience is to provide us with feedback on this manual.

Your feedback will help shape the future of our product documentation and the overall service we provide. We appreciate the opportunity to see ourselves as our customers see us and are eager to gather ideas on how we have been helping or how we can do better.

To serve you best, please send an email with the following information to

techwriting@ravenind.com

-Accuflow Vortex Installation Manual

-Manual No. 016-0171-591 Rev. C

-Any comments or feedback (include chapter or page numbers if applicable).

-Let us know how long have you been using this or other Raven products.

We will not share your email or any information you provide with anyone else. Your feedback is valued and extremely important to us.

Thank you for your time.

Assembly Overview

	<p>⚠ WARNING</p> <p>Anhydrous ammonia in vapor form can cause serious injury or death. Pipe joints must be properly sealed with thread sealant, to prevent leaks.</p>
---	--

Inlet Manifold Assembly

1. Apply thread sealant to all male threads.
2. Assemble the 2" pipe nipple into the cooler inlet.
3. Connect the ball valve to the pipe nipple. Verify that the ball valve is oriented so, when the valve is in the open position, the handle points away from the cooler assembly.

FIGURE 1. Open Valve Handle Position

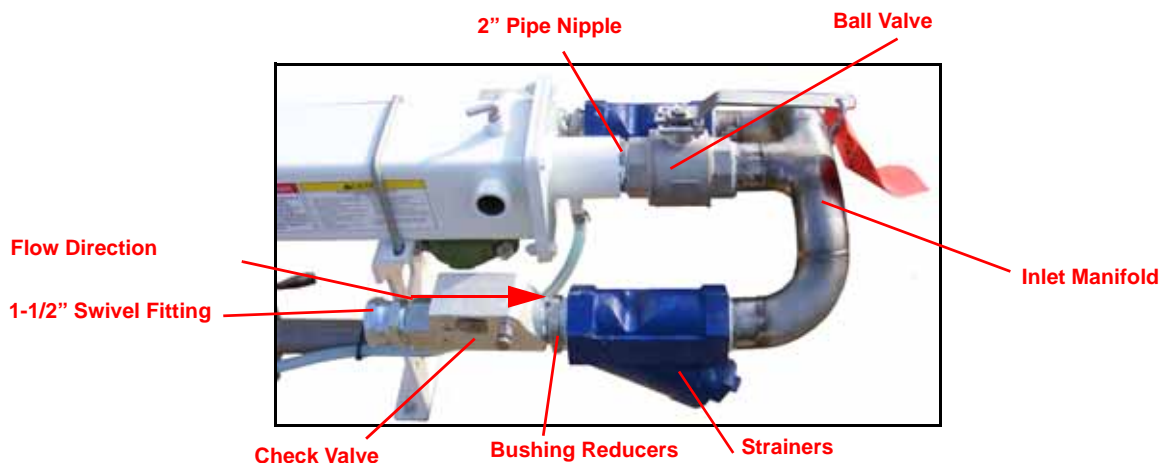

4. Attach the inlet manifold so the horns are offset below the cooler assembly.
5. Attach the strainers on the end of the inlet manifold.
6. Attach the 2" x 1-1/2" bushing reducer to the strainer.
7. Attach the check valve on the 1-1/2" end of the bushing reducer.
 - a. Ensure the flow direction is correct.
 - b. Assemble the check valve with the bleeder on the same side of the cooler as the gauges.

FIGURE 2. Bleeder Valve Location

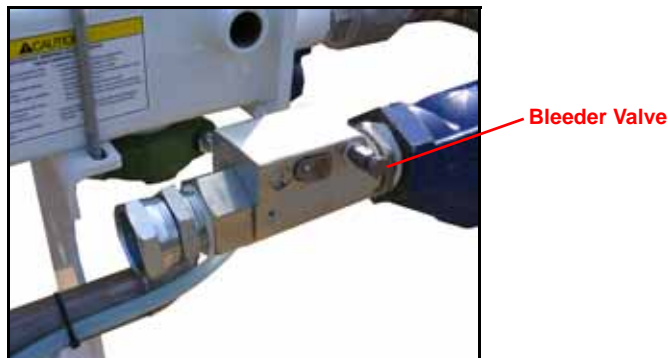

- c. Assemble the check valve with the pressure relief valve on the opposite side as the cooler gauges.

FIGURE 3. Proper Check Valve Orientation

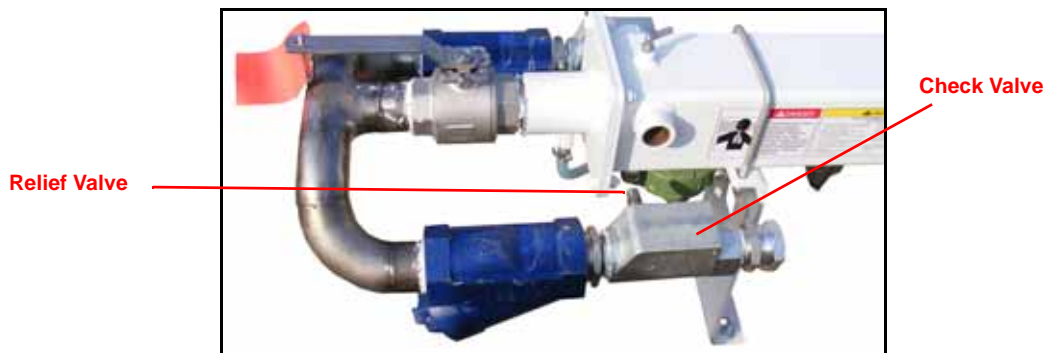

8. Attach the 1-1/2" swivel fitting to the end of the check valve.

Outlet Assembly

1. Apply thread sealant all male threads.
2. Install the 1-1/2" pipe nipple to the top port of the outlet T-fitting.

FIGURE 4. Outlet Assembly

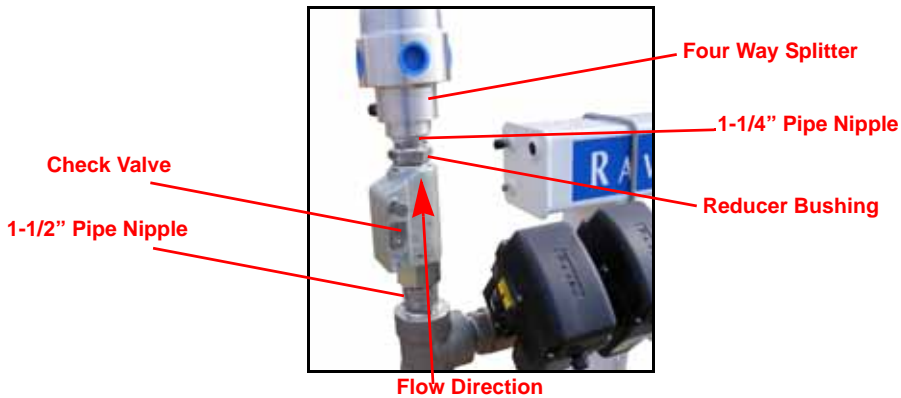

3. Install the check valve assembly to the outlet assembly. Verify the flow direction is correct during installation.
4. Install the 1-1/2" x 1-1/4" reducer bushing on the end of the check valve.
5. Secure the 1-1/4" NPT pipe nipple into the reducer bushing.
6. Install the four way splitter on the end of the 1-1/4" NPT. The final orientation of the splitter will have the swivel fittings on the left, right, and front sides with the plug assembly on the rear.
7. Remove the 1/4" NPT plug in the splitter and replace with hydrostatic relief valve.

FIGURE 5. 1/4" NPT Valve

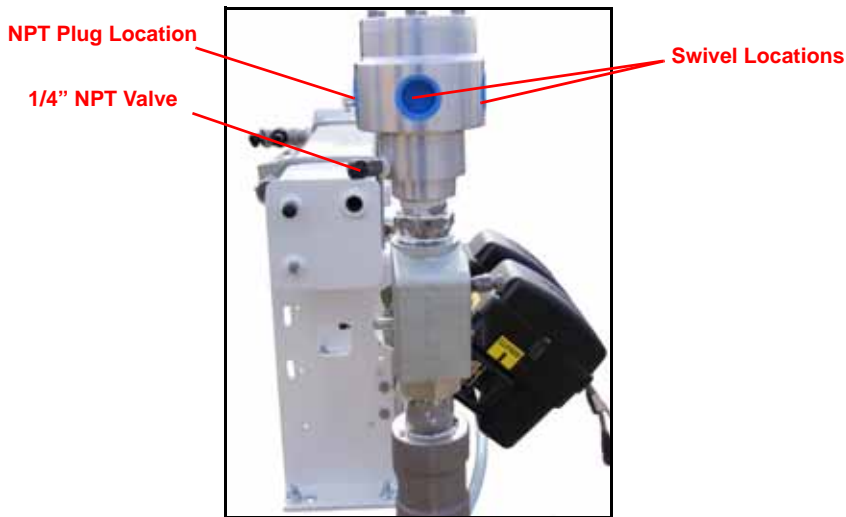

Leak Test

Prior to the installation on the tool bar, plug the system and perform a leak test with pressurized air (100 P.S.I minimum/250 P.S.I maximum) and soapy water.

Vapor Port Assembly

1. Apply thread sealant to all male threads.
2. Screw the 1" pipe nipple into the vapor port on the AccuFlow™ Vortex.
3. Screw the cross fitting onto the 1" pipe nipple.
4. Install the two straight hose barbs so they run parallel with the side of the AccuFlow Vortex.
5. Install the 90° hose barb in the remaining port on the cross fitting.

FIGURE 6. Cross Fitting Assembly

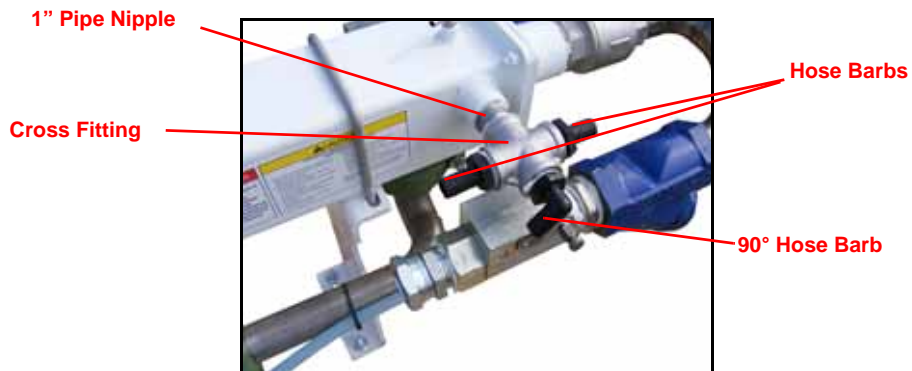

FIGURE 7. Cross Fitting Assembly



Installing Toolbar Mounting Brackets

1. Use two 4-1/32" W x 5-1/4" L x 5/8" U-bolts and two 5/8" locking nuts to attach the left and right mounting brackets to the tool bar frame behind the rear fold tower plates.

Important: Leave the mounting brackets slightly loose to allow for bracket adjustment. The mounting bracket location will vary to the left or right of center depending on location of the standards.

FIGURE 1. Installed Mounting Brackets

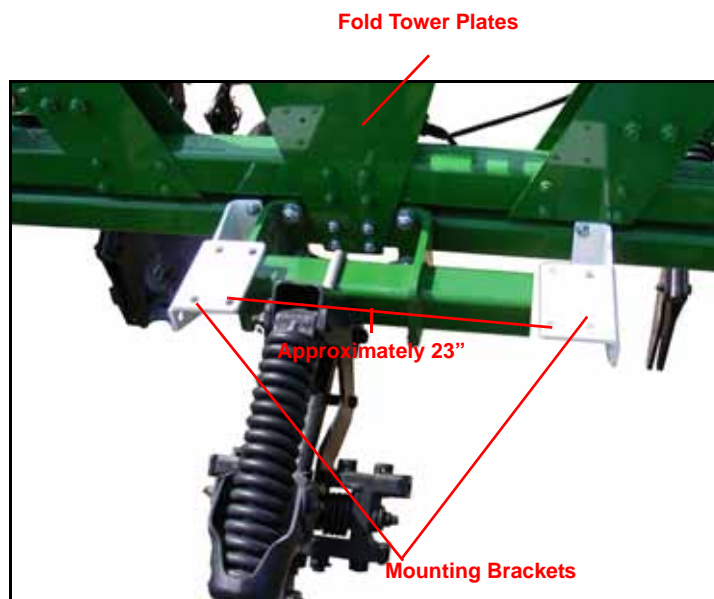

Attaching Cooler to Mounting Brackets

1. Secure lifting straps on each end of the cooler at the locations identified in **Figure 2**.

FIGURE 2. Proper and Improper Lifting Strap Location

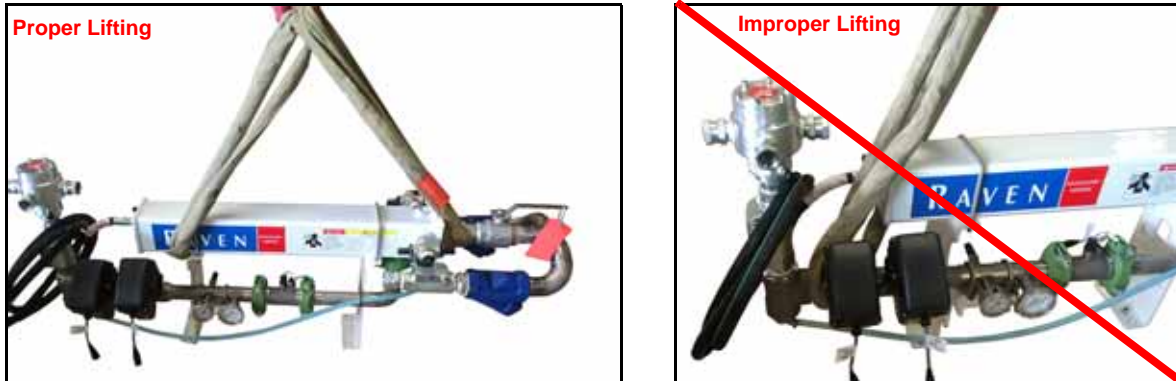

2. Attach the lifting straps to the hoist.
3. Slowly lift and maneuver the cooler into the installation location on the mounting brackets.

Note: Ensure adequate clearance between the cooler and the standard so the standard has a full range of motion and does not contact the cooler assembly. Also verify that the ball valve handle can be pulled to the full off position with a safety rope.

4. Use two 5/8" x 1-1/2" bolts and 5/8" locking nuts to secure the AccuFlow to the mounting brackets.

FIGURE 3. Cooler Mounting Assembly



5. Attach the inlet manifold mounting bracket to the toolbar using one 4-1/32" W x 5-1/4" L x 5/8" U-Bolt and two 5/8" locking nuts. Refer to **Figure 4**.
6. Attach the inlet manifold to the support bracket using two clamping U-Bolts. Refer to **Figure 4**.
7. Tighten all nuts on the mounting brackets and the support brackets.

FIGURE 4. Installed Inlet Manifold Supporting Bracket

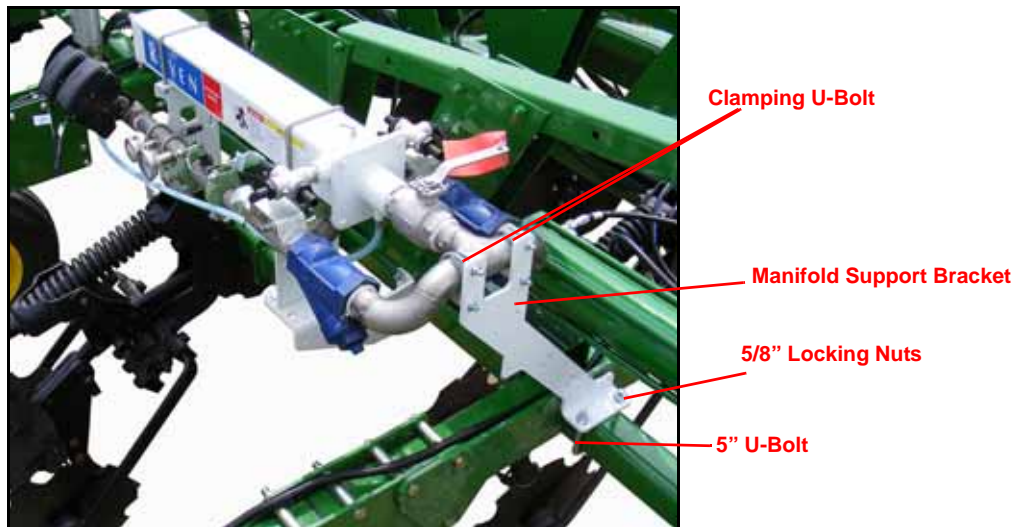

AccuDepth Bracket Installation

1. Install the AccuDepth bracket to the manifold support bracket.

FIGURE 5. Installed AccuDepth Mounting Bracket

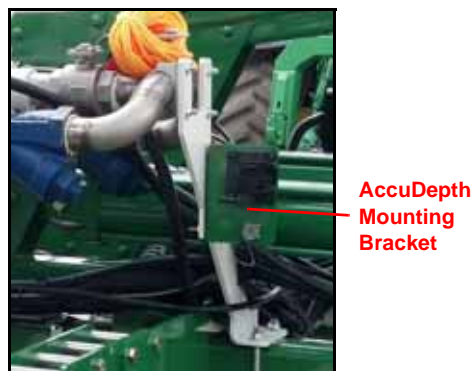

Impellicone Assembly

The following sections provide instructions for proper installation and mounting of the impellicones on the implement.

	<p>⚠ WARNING</p> <p>Anhydrous ammonia in vapor form can cause serious injury or death. Pipe joints must be properly sealed with thread sealant, to prevent leaks.</p>
--	--

1. Apply thread sealant to the all male threads.
2. Securely install the hose barbs and plugs into the ports on impellicone head. Space the barbs out as evenly as possible and seal any unused ports with plugs.

FIGURE 1. Impellicone with Alternating Barbs and Plugs Installed



3. Screw the impellicone to one end of the 8" pipe.
4. Screw the 90° elbow to the 8" pipe.
5. Screw the 1" x 2" pipe into the open end of the 90° elbow.

- Screw the On/Off valve to the 1" x 2" pipe. Ensure that the flow direction is correct.

FIGURE 2. Pipe and 90° Elbow Assembly

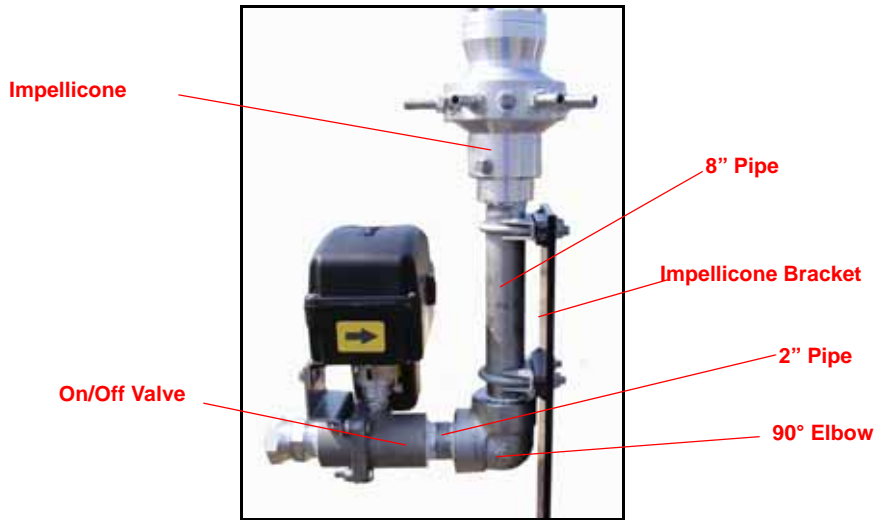

- Mount the impellicone assembly to the mounting bracket using two clamping u-bolts.

Mounting the Impellicone to the Toolbar

- Use two 3/8" x 4" W x 5" L U-bolts to mount the impellicone to the front cross tube.

FIGURE 3. Mounting the Impellicone Assembly

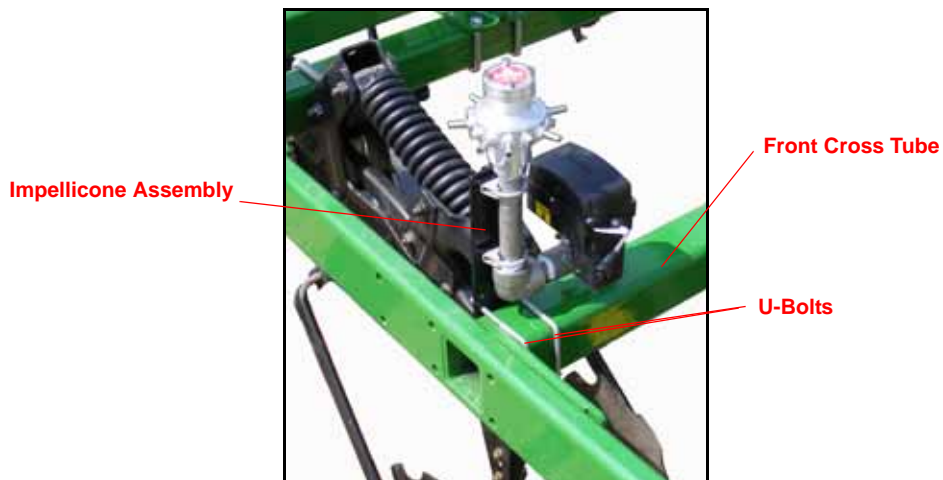

- Mount one impellicone/valve assembly to the end of each inner wing.

FIGURE 4. Impellicone Installation Locations and GreenStar™ Rate Controller on Toolbar

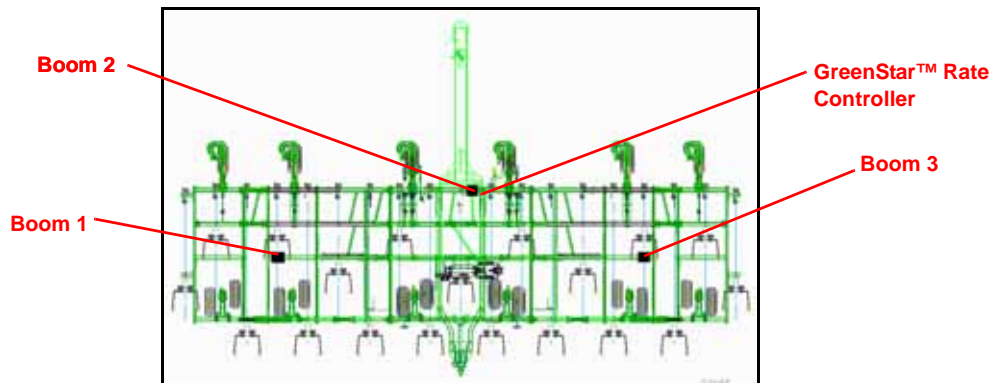

3. Mount the middle impellicone assembly near the center of the front cross tube. Ensure the toolbar decals are visible from the cab of the tractor.

FIGURE 5. Installed Impellicone with Visible Decals



4. Verify there is proper clearance to the toolbar wheels and standards to allow full range of motion.

Cable Harness Connection

General Harness Instructions

- Verify the wiring harness do not get pinched by moving parts on the implement (e.g. pinching may occur on a 3 pt hitch).
- Tie-strap harness at least every 30 cm (12 in) to frame. Follow routing of the existing harnesses as much as possible.
- Harnesses should only be used on intended platforms and should not be modified in any way.

1. Route the Raven product cable to GreenStar™ rate controller cable along the toolbar frame. If possible, use existing P-clamps.
2. Connect one end of a Raven 24' On/Off extension cable to the section 1 valve.
3. Connect the other end of the Raven 24' On/Off extension cable to product cable labeled Boom 1.
4. Connect one end of a Raven 24' On/Off extension to the section 3 valve.
5. Connect the other end of the Raven 24' On/Off extension cable to product cable labeled Boom 3.
6. Connect the Raven 12' On/Off valve extension cable to the section 2 valve.
7. Route the 12' On/Off valve extension cable along the frame and connect the extension cable to the product cable marked Boom 2.

GreenStar™ Rate Controller Installation

Installation Guidelines

- Ensure the GreenStar™ Rate controller is installed out of the way of moving parts such as wheel modules and markers.
- Ensure the GreenStar™ Rate controller and harnesses do not interfere with the folding and unfolding of the implement.
- Route the GreenStar™ Rate controller wiring harnesses along existing hoses and wiring as much as possible.
- Provide enough slack around moving pivot points when installing a wiring harness.

Install the GreenStar™ rate controller to the toolbar near the impellicone on boom 2.

FIGURE 6. GreenStar™ Rate Controller.



1. This chapter contains instructions for connecting the AccuFlow Vortex system row and vapor tubes to a John Deere toolbar and connecting the NH₃ supply lines.

	⚠ WARNING
Anhydrous ammonia in vapor form can cause serious injury or death. Pipe joints must be properly sealed with thread sealant, to prevent leaks.	

Routing Hose Between Cooler and Section Valves

1. Route the NH₃ hose along the machine frame.

FIGURE 1. Installed NH₃ Lines

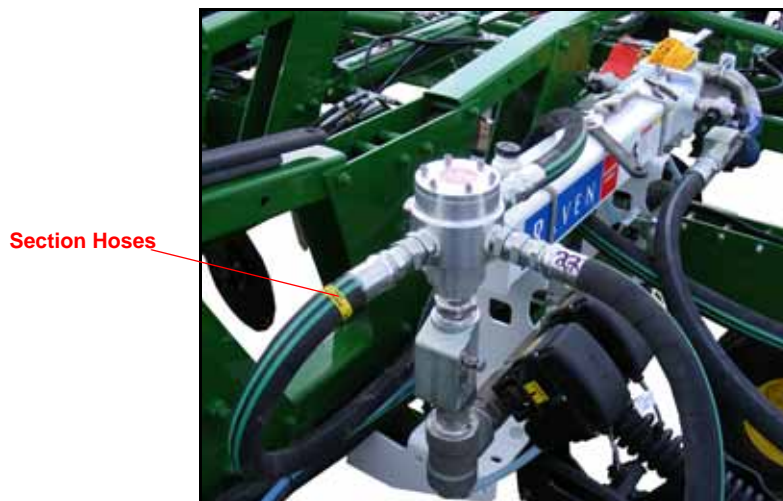

2. Use straps and P-clamps to secure the NH₃ hose to the frame.
3. Inspect the NH₃ routing to ensure the lines can not be pinched or damaged by the tripping of a standard, raising of wheels, or folding of wing sections.

FIGURE 2. NH₃ Hose Routing



Supply Line Installation

1. Route the 1-1/2" NH₃ supply lines to the AccuFlow™ Vortex.
2. Install the 1-1/2" NH₃ supply line hoses to the break away couplers.
3. Connect the other end of the supply lines to the 1-1/2" swivel fittings at the cooler inlet.

Note: The supply line to the left (Supply Line 1) mounts on the side of the cooler closer to the nurse tanks. The supply line to the right (Supply Line 2) mounts on the side of the cooler closer to the tractor.

4. Secure the 1-1/2" hoses with P-clamps.

FIGURE 3. Supply Line Installation

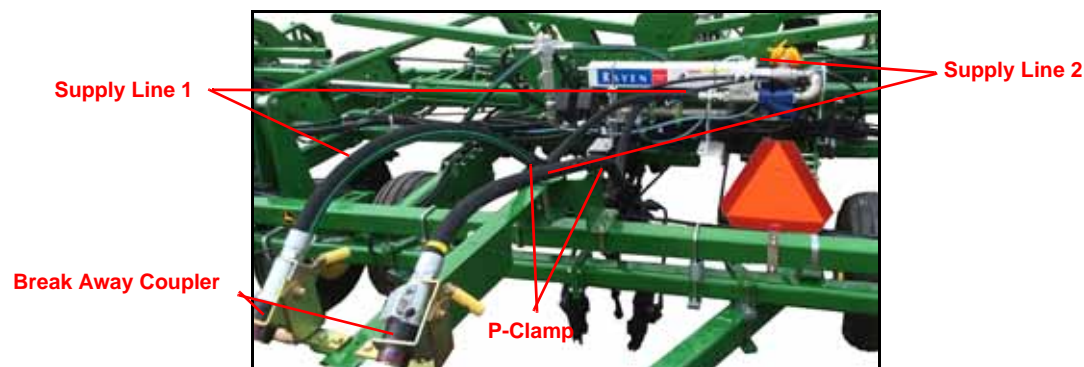

Applicator Line Installation

1. Cut the 3/8" EVA tubing to the required length.

Note: For proper application all EVA hose must be cut to the same length.

2. Route the EVA hose from the impellicone to the individual standards.

FIGURE 4. EVA Hose Routing



3. Secure the EVA hose to the frame. If possible, use existing hose and P-clamps to secure the hose. Use additional steel straps and rubber P-clamps as needed. When routing to the outer wing, only use existing P-clamps on the fold down tower to ensure the lines are captured when folding.
4. Coil and secure excess hose to the standard.

Vapor Line Installation

1. Route a vapor hose to the furthest vapor tube and cut to length.
2. Measure the length of the vapor line routed in **step 1**.
3. Cut all required vapor hoses to the length obtained in **step 2**.
4. Route all the vapor hoses to the vapor tubes.

FIGURE 5. Vapor Line Installation.



5. Secure the vapor hose to the frame using existing P-clamps. Use additional steel straps or P-clamps as needed.
6. Connect the vapor hose to the vapor ports on the cooler.

Bleed Line Hose Routing

1. Apply thread sealant to all male threads.
2. Route the bleed hose to the front of the tool bar.
3. Use the supplied mounting bracket, u-bolts, and nuts to secure the bleed hose.

FIGURE 6. Secured Bleed Hose



FIGURE 7. Attached Bleed Hose

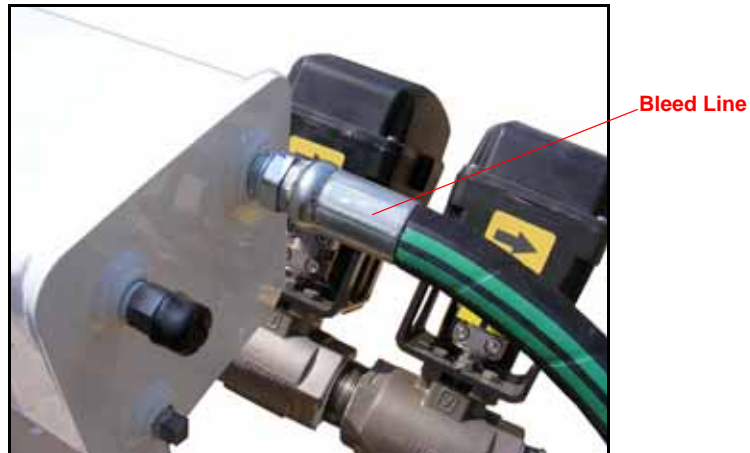

4. Connect one end of the 1/2" high pressure hose to the back of the Vortex cooler and the other end to the needle valve.
5. Connect the 3/8" low pressure hose to the other side of the needle valve.
6. Route the 3/8" low pressure hose to the 3/8" hose barb tee near the cooler. This will turn the bleed off into the cooler's vapor chamber.

Emergency Shut-off Rope Installation

1. Using the provided quick link on the shut-off handle, securely tie a length of rope to the emergency shut-off valve on the cooler.
2. Route the rope so that it is accessible from the tractor cab and, when pulled, the emergency shut-off valve closes completely.

FIGURE 8. Emergency Shut-off Rope Installation

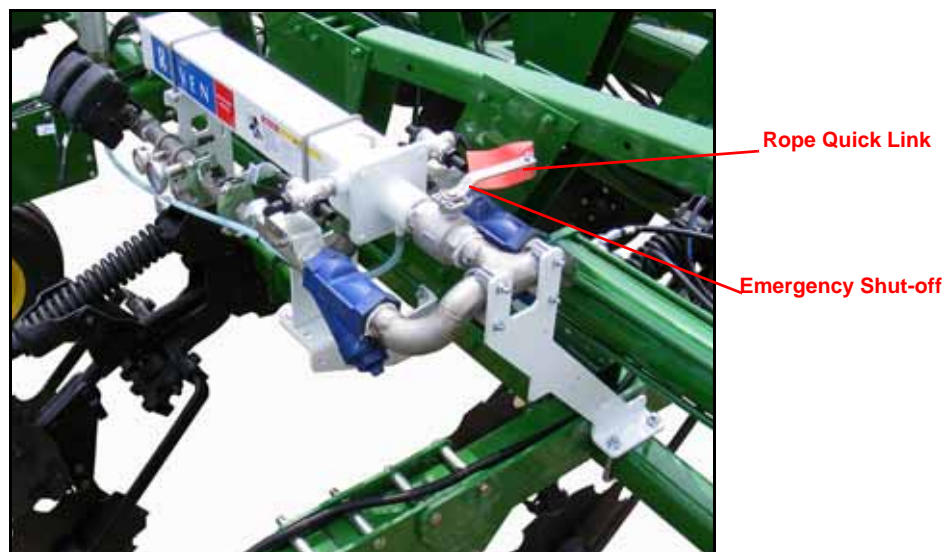

CHAPTER

7

Replacement Parts

Replacement Parts

TABLE 1. Inlet Plumbing Components

Part Number	Description
063-0173-627	2" Inlet Shutoff Valve
063-0173-655	2" Y-Strainer (Strainer ,Screen, Gaskets, Magnets)
063-0173-691	Back Check Valve W/ Hydrostats
063-0173-692	Back Check Valve W/ Bleed Valve
116-0159-755	2" Inlet Manifold reversed
219-0000-161	2" Strainer Gasket
333-9000-071	40 Mesh Strainer Screen
418-0000-001	Strainer Magnet

TABLE 2. Vortex Cooler and Bleed Components

Part Number	Description
063-0173-663	Vortex Cooler Assembly (Cooler, Decals, Relief Valve)
117-0171-591	Seal/Hardware Kit
117-0171-592	Decal Kit
214-0001-049	Hose, 12', 1/2", NH3
333-0006-038	2-1/2" Gruv-Lok Coupling w/Gasket
334-0001-064	1/4" Bleed Valve
334-0002-005	Relief Valve
116-0159-752	Weldment, Outlet Manifold

TABLE 3. Flowmeter Components

Part Number	Description
063-0171-669	Flowmeter Sensor Assembly w/Nut
063-0173-618	RFM 60SG Flowmeter
117-0171-590	RFM 60SG Internal Replacement Parts Kit
333-0006-039	2" x 1-1/2" Gruv-Lok Coupling w/Gasket

TABLE 4. Gauge Tree and Sensors Components

Part Number	Description
116-0159-743	1-1/2" Gauge Tree Manifold
417-0001-030	0-250 PSI Pressure Gauge
417-0001-031	-40F - 120F Temperature Gauge
422-0000-090	Transducer, Pressure, 0-250 PSI, 1/4" MNPT, Stainless Steel (Metri-Pack)
422-0000-119	Transducer, Pressure, 1-5 V, 0-250 PSI, 1/4" NPT (Deutsch)

TABLE 5. Control and On/Off Valve Components

Part Number	Description
063-0173-664	Standard Control Valve Motor Assembly
063-0173-665	On/Off Motor Assembly
063-0173-667	1-1/2" Standard Control Valve
063-0173-668	1-1/2" On/Off Valve Assembly
117-0171-219	Valve Position Indicator Kit

TABLE 6. Outlet Plumbing Components

Part Number	Description
063-0173-692	Back Check Valve W/ Bleed Valve

TABLE 7. Supply Hoses, Break-Away, Splitter, Section Manifold Components

Part Number	Description
063-0172-978	Valve, On/Off, 1" Ball, NH3
214-0001-048	Hose Supply, 10', 1.5", NH3
214-0001-050	Hose Supply, 22', 1", NH3
333-0001-030	Fitting, 1" Swivel
333-0001-031	Fitting, 1-1/2" Swivel
333-0002-245	Impellicone, IP-1300, John Blue
333-0002-301	Impellicone Splitter
333-0002-307	Coupler, Breakaway, 1-1/2" NH3

TABLE 8. Cabling

Part Numbers	Description
115-0171-833	Cable, Ext, 12', NH3, On/Off Valve
115-0171-834	Cable, Ext, 24', NH3, On/Off Valve
115-0171-837	Cable, 12' SCS 4400, 3 Section, Master

H

Hose & Supply Line Installation 33

Emergency Shut-off Rope 37

I

Impellicone Installation

Single Impellicone for 14 or 18 Row Toolbars 29

P

Preparation

Point of Reference 9

Required Tools and Supplies 21

S

Safety Information 1

RAVEN

Limited Warranty

What Does this Warranty Cover?

This warranty covers all defects in workmanship or materials in your Raven Applied Technology Division product under normal use, maintenance, and service when used for intended purpose.

How Long is the Coverage Period?

Raven Applied Technology products are covered by this warranty for 12 months from the date of retail sale. In no case will the Limited Warranty period exceed 24 months from the date the product was issued by Raven Industries Applied Technology Division. This warranty coverage applies only to the original owner and is non-transferable.

How Can I Get Service?

Bring the defective part and proof of purchase to your Raven dealer. If the dealer approves the warranty claim, the dealer will process the claim and send it to Raven Industries for final approval. The freight cost to Raven Industries will be the customer's responsibility. The Return Materials Authorization (RMA) number must appear on the box and all documentation (including proof of purchase) must be included inside the box to be sent to Raven Industries.

What Will Raven Industries Do?

Upon confirmation of the warranty claim, Raven Industries will (at our discretion) repair or replace the defective product and pay for the standard return freight, regardless of the inbound shipping method. Expedited freight is available at the customer's expense.

What is not Covered by this Warranty?

Raven Industries will not assume any expense or liability for repairs made outside our facilities without written consent. Raven Industries is not responsible for damage to any associated equipment or products and will not be liable for loss of profit, labor, or other damages. The obligation of this warranty is in lieu of all other warranties, expressed or implied, and no person or organization is authorized to assume any liability for Raven Industries.

Damages caused by normal wear and tear, misuse, abuse, neglect, accident, or improper installation and maintenance are not covered by this warranty.



Extended Warranty

What Does this Warranty Cover?

This warranty covers all defects in workmanship or materials in your Raven Applied Technology Division product under normal use, maintenance, and service when used for intended purpose.

Do I Need to Register My Product to Qualify for the Extended Warranty?

Yes. Products/systems must be registered within 30 days of retail sale to receive coverage under the Extended Warranty. If the component does not have a serial tag, the kit it came in must be registered instead.

Where Can I Register My Product for the Extended Warranty?

To register, go online to www.ravenhelp.com and select Product Registration.

How Long is the Extended Warranty Coverage Period?

Raven Applied Technology products that have been registered online are covered for an additional 12 months beyond the Limited Warranty for a total coverage period of 24 months from the date of retail sale. In no case will the Extended Warranty period exceed 36 months from the date the product was issued by Raven Industries Applied Technology Division. This Extended Warranty coverage applies only to the original owner and is non-transferable.

How Can I Get Service?

Bring the defective part and proof of purchase to your Raven dealer. If the dealer approves the warranty claim, the dealer will process the claim and send it to Raven Industries for final approval. The freight cost to Raven Industries will be the customer's responsibility. The Return Materials Authorization (RMA) number must appear on the box and all documentation (including proof of purchase) must be included inside the box to be sent to Raven Industries. In addition, the words "Extended Warranty" must appear on the box and all documentation if the failure is between 12 and 24 months from the retail sale.

What Will Raven Industries Do?

Upon confirmation of the product's registration for the Extended Warranty and the claim itself, Raven Industries will (at our discretion) repair or replace the defective product and pay for the standard return freight, regardless of the inbound shipping method. Expedited freight is available at the customer's expense.

What is Not Covered by the Extended Warranty?

Raven Industries will not assume any expense or liability for repairs made outside our facilities without written consent. Raven Industries is not responsible for damage to any associated equipment or products and will not be liable for loss of profit, labor, or other damages. Cables, hoses, software enhancements, and remanufactured items are not covered by this Extended Warranty. The obligation of this warranty is in lieu of all other warranties, expressed or implied, and no person or organization is authorized to assume any liability for Raven Industries.

Damages caused by normal wear and tear, misuse, abuse, neglect, accident, or improper installation and maintenance are not covered by this warranty.