

SYSTEM DRAWING, CNH INTELLISTEER, SBGUIDANCE, W/ IBBC, EXTERNAL GPS

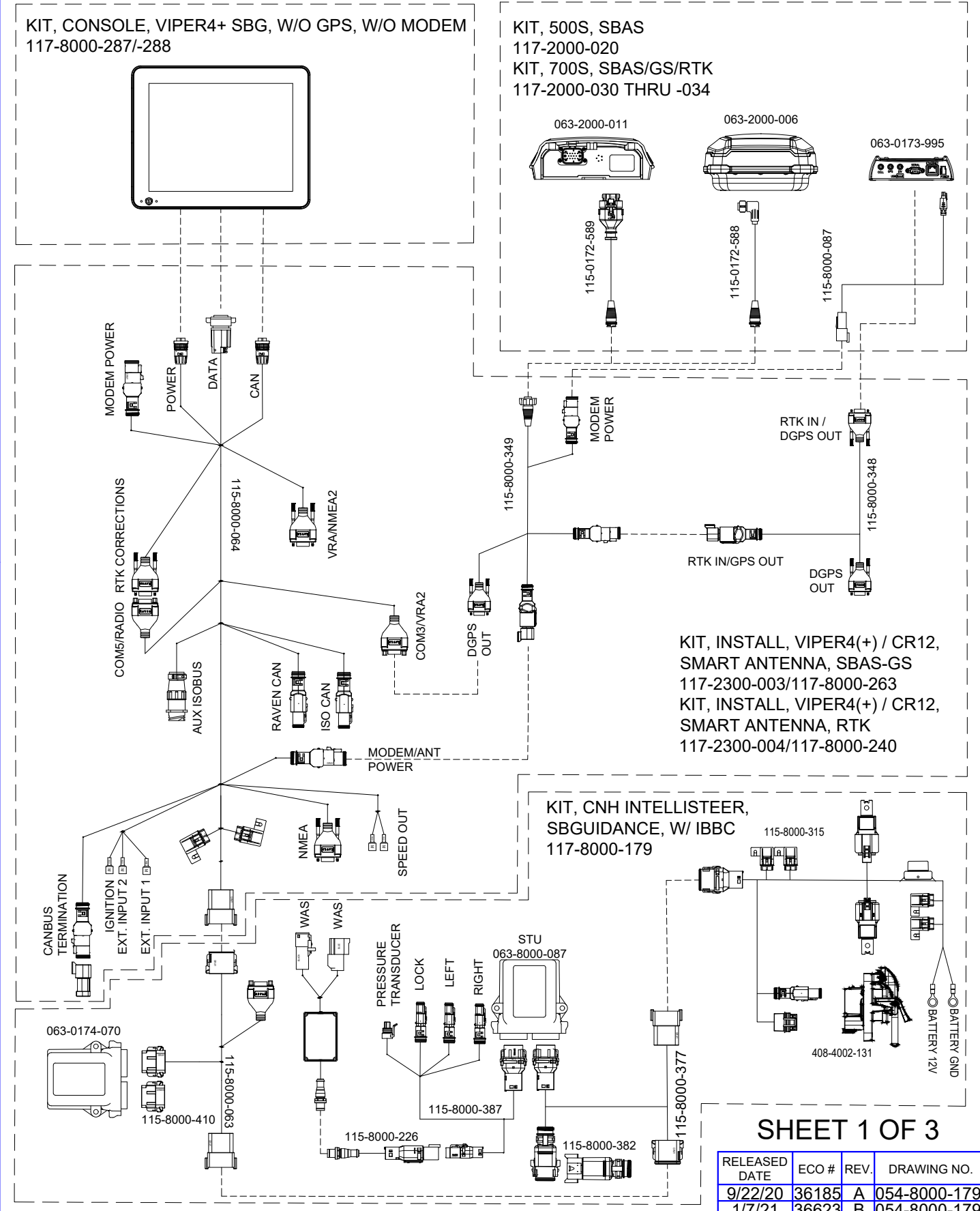

SHEET 1 OF 3

RELEASED DATE	ECO #	REV.	DRAWING NO.
9/22/20	36185	A	054-8000-179
1/7/21	36623	B	054-8000-179

SYSTEM DRAWING, CNH INTELLISTEER, SBGUIDANCE, W/ IBBC, INTERNAL GPS, SLINGSHOT

KIT, CONSOLE, VIPER 4+SBG, SLINGSHOT
117-8000-271/-273/-275/-277

063-0173-995

063-2000-005

115-8000-087

115-8000-004

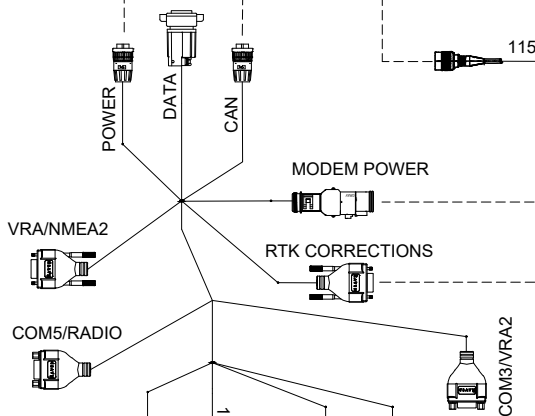

KIT, INSTALL, VIPER4(+)/CR12, INTERNAL GPS, SLINGSHOT
117-8000-241/-244

KIT, CNH INTELLISTEER,
SBGUIDANCE, W/ IBBC
117-8000-179

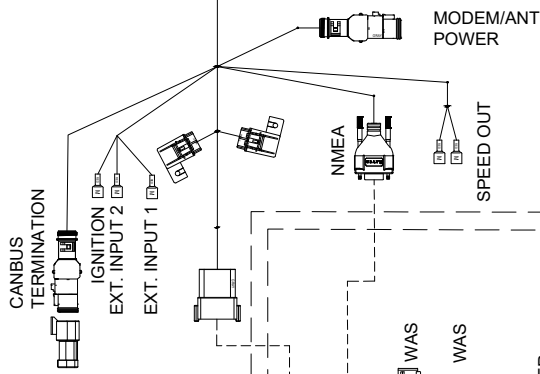

063-0174-070

115-8000-410

115-8000-063

115-8000-226

115-8000-387

115-8000-382

115-8000-377

115-8000-315

408-4002-131

BATTERY 12V
GND

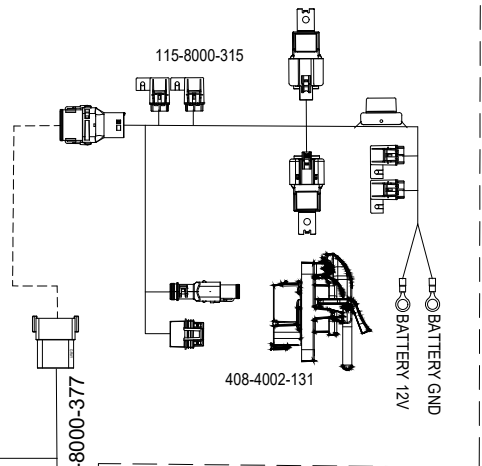
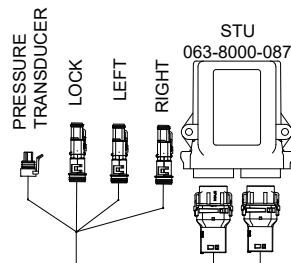

SHEET 2 OF 3

RELEASED DATE	ECO #	REV.	DRAWING NO.
9/22/20	36185	A	054-8000-179
1/7/21	36623	B	054-8000-179

SYSTEM DRAWING, CNH INTELLISTEER, SBGUIDANCE, W/ IBBC, INTERNAL GPS, RADIO

KIT, CONSOLE, VIPER 4+ SBG, RADIO
117-8000-270/-272/-274/-276

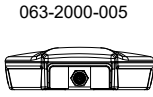
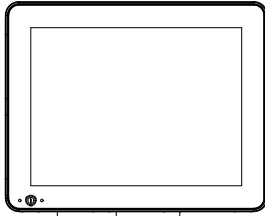

KIT, RADIO ANTENNA
117-8000-313

121-8000-008

115-8000-106

KIT, INSTALL, VIPER4(+)/CR12, INTERNAL GPS, RADIO
117-8000-236/-243

KIT, CNH INTELLISTEER,
SBGUIDANCE, W/ IBBC
117-8000-179

115-8000-315

408-4002-131

BATTERY 12V
GND

SHEET 3 OF 3

RELEASED DATE	ECO #	REV.	DRAWING NO.
9/22/20	36185	A	054-8000-179
1/7/21	36623	B	054-8000-179

