

SYSTEM DRAWING, CNH INTELLISTEER, SBGUIDANCE, W/O IBBC, EXTERNAL GPS

KIT, CONSOLE, VIPER4+ SBG, W/O GPS, W/O MODEM
117-8000-287/-288

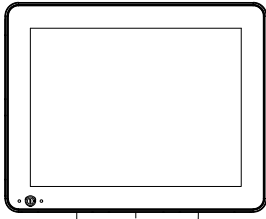

KIT, 500S, SBAS
117-2000-020
KIT, 700S, SBAS/GS/RTK
117-2000-030 THRU -034

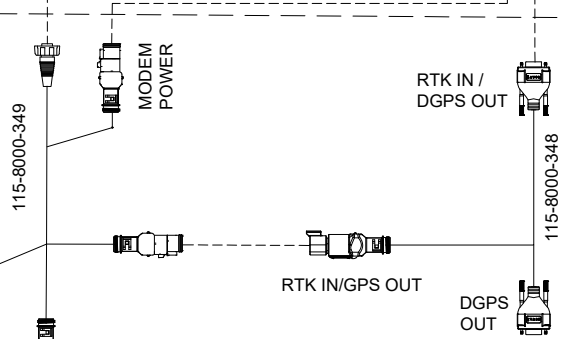
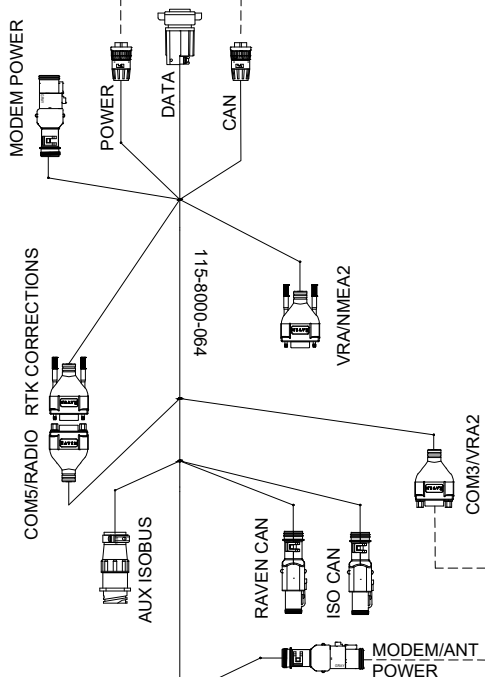
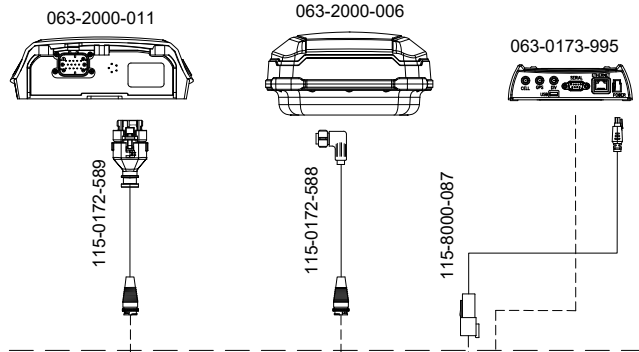

KIT, INSTALL, VIPER4(+) / CR12, SMART ANTENNA, SBAS-GS
117-2300-003/117-8000-263
KIT, INSTALL, VIPER4(+) / CR12, SMART ANTENNA, RTK
117-2300-004/117-8000-240

KIT, CNH INTELLISTEER, SBGUIDANCE, W/O IBBC
117-8000-169

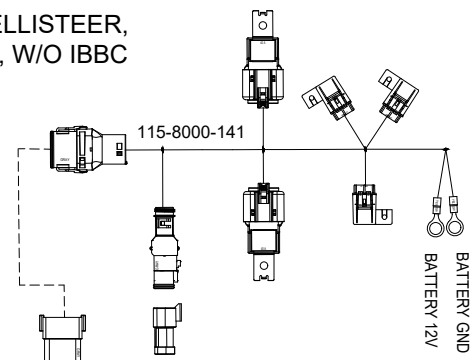
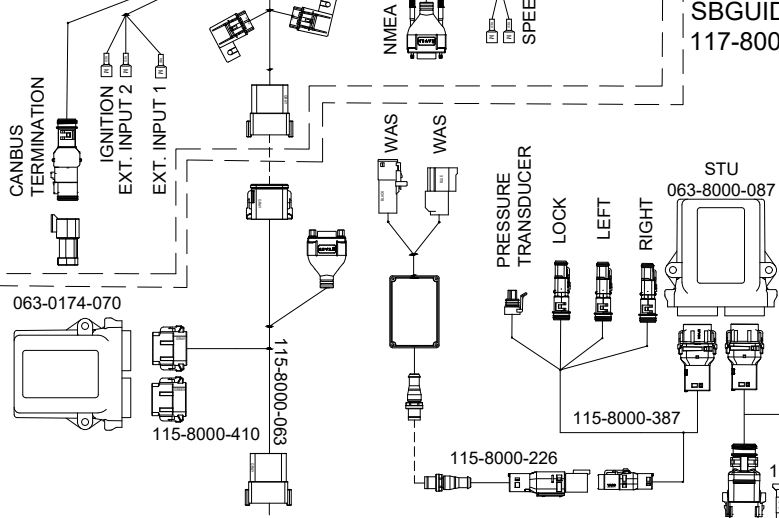

SHEET 1 OF 3

RELEASED DATE	ECO #	REV.	DRAWING NO.
9/22/20	36185	A	054-8000-169
1/7/21	36623	B	054-8000-169

SYSTEM DRAWING, CNH INTELLISTEER, SBGUIDANCE, W/O IBBC, INTERNAL GPS, SLINGSHOT

KIT, CONSOLE, VIPER 4+SBG, SLINGSHOT
117-8000-271/-273/-275/-277

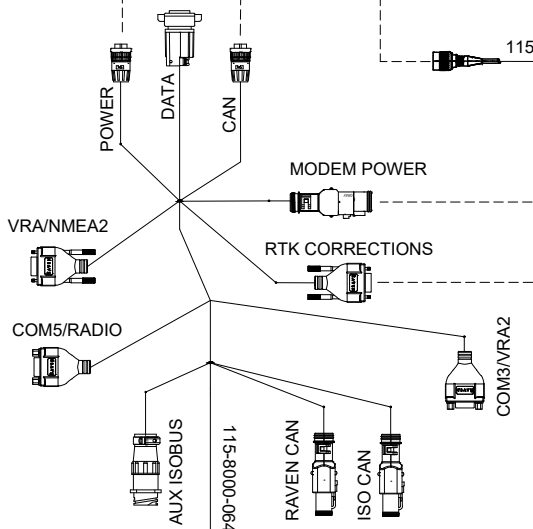
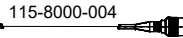
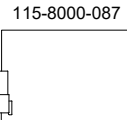
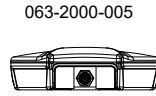
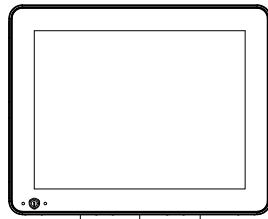

KIT, INSTALL, VIPER4(+)/CR12, INTERNAL GPS, SLINGSHOT
117-8000-241/-244

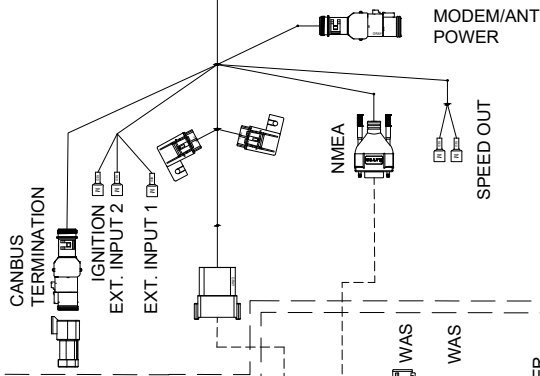

KIT, CNH INTELLISTEER, SBGUIDANCE, W/O IBBC
117-8000-169

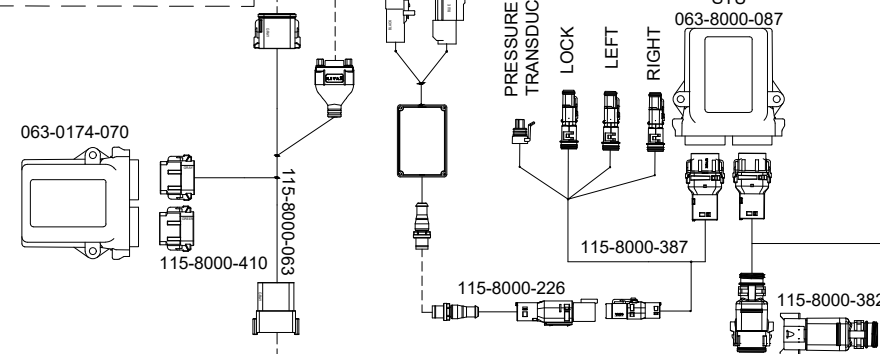
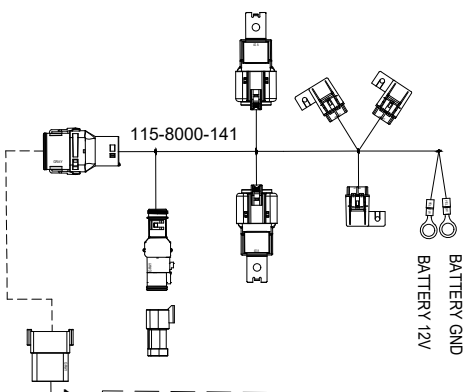

SHEET 2 OF 3

RELEASED DATE	ECO #	REV.	DRAWING NO.
9/22/20	36185	A	054-8000-169
1/7/21	36623	B	054-8000-169

SYSTEM DRAWING, CNH INTELLISTEER, SBGUIDANCE, W/O IBBC, INTERNAL GPS, RADIO

KIT, CONSOLE, VIPER 4+ SBG, RADIO
117-8000-270/-272/-274/-276

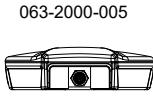
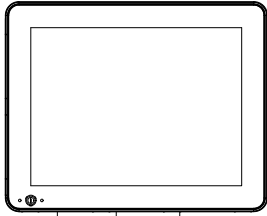

063-2000-005

KIT, RADIO ANTENNA
117-8000-313

121-8000-008

115-8000-004

115-8000-106

COM5/RADIO RTK CORRECTIONS

POWER

DATA

CAN

MODEM POWER

VRA/NMEA2

COM3/VRA2

AUX ISOBUS

115-8000-000

RAVEN CAN

ISO CAN

MODEM/ANT POWER

KIT, INSTALL, VIPER4(+)/CR12, INTERNAL GPS, RADIO
117-8000-236/-243

KIT, CNH INTELLISTEER, SBGUIDANCE, W/O IBBC
117-8000-169

CANBUS TERMINATION

IGNITION EXT. INPUT 2

EXT. INPUT 1

115-8000-000

NMEA

SPEED OUT

WAS

WAS

PRESSURE TRANSDUCER

LOCK

LEFT

RIGHT

STU

063-8000-087

115-8000-387

115-8000-382

115-8000-226

115-8000-141

BATTERY 12V

BATTERY GND

115-8000-377

063-0174-070

115-8000-410

115-8000-693

SHEET 3 OF 3

RELEASED DATE	ECO #	REV.	DRAWING NO.
9/22/20	36185	A	054-8000-169
1/7/21	36623	B	054-8000-169