

# SYSTEM DRAWING, JOHN DEERE AUTOTRAC READY 6000 SERIES, SBGUIDANCE, W/ IBBC, EXTERNAL GPS

KIT, CONSOLE, VIPER4+ SBG, W/O GPS, W/O MODEM  
117-8000-287/-288

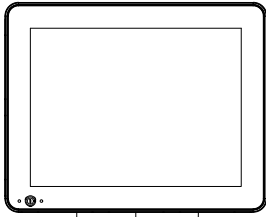

KIT, 500S, SBAS  
117-2000-020  
KIT, 700S, SBAS/GS/RTK  
117-2000-030 THRU -034

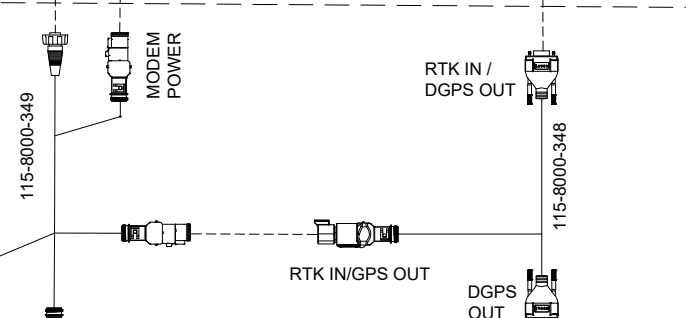
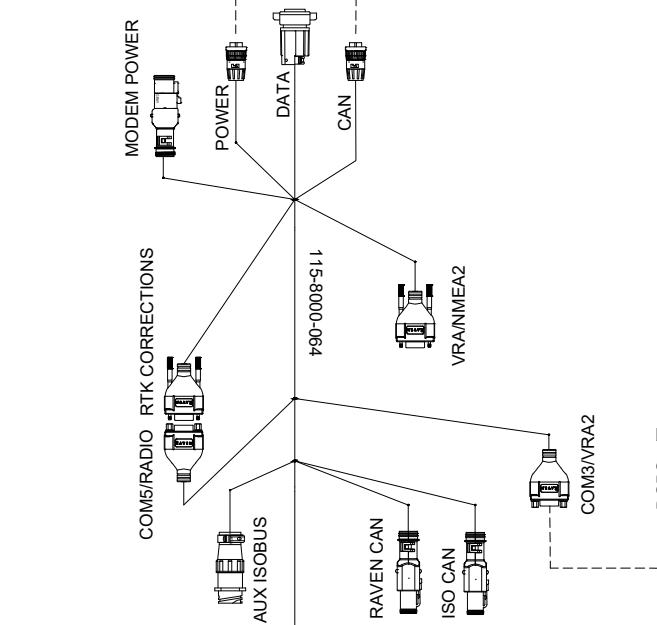
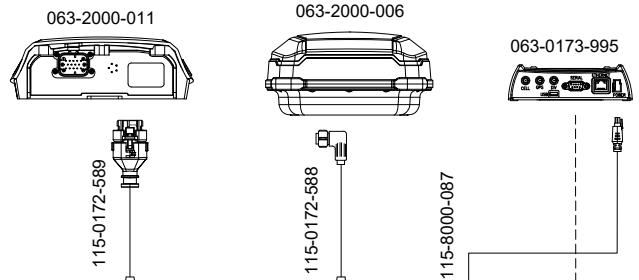

KIT, INSTALL, VIPER4(+)/CR12,  
SMART ANTENNA, SBAS-GS/RTK  
117-2300-003/117-2300-004/  
117-8000-240/117-8000-263

KIT, JOHN DEERE AUTOTRAC READY  
6000 SERIES, SBGUIDANCE, W/ IBBC  
117-8000-170

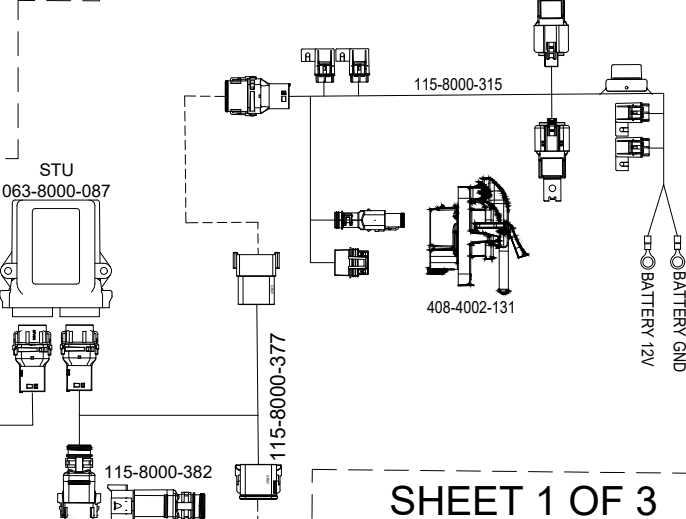
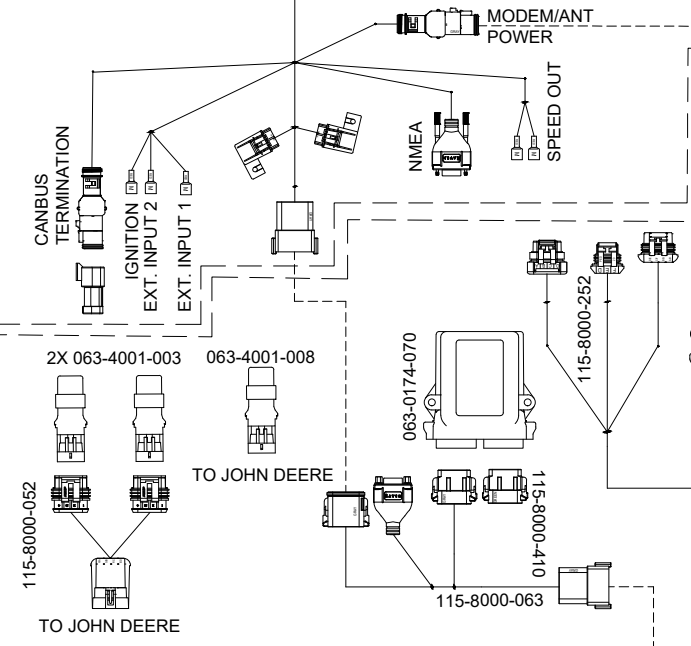

SHEET 1 OF 3

RELEASED DATE	ECO #	REV.	DRAWING NO.
11/2/20	36260	A	054-8000-170

# SYSTEM DRAWING, JOHN DEERE AUTOTRAC READY 6000 SERIES, SBGUIDANCE, W/ IBBC, INTERNAL GPS, SLINGSHOT

KIT, CONSOLE, VIPER 4+SBG, SLINGSHOT  
117-8000-271/-273/-275/-277

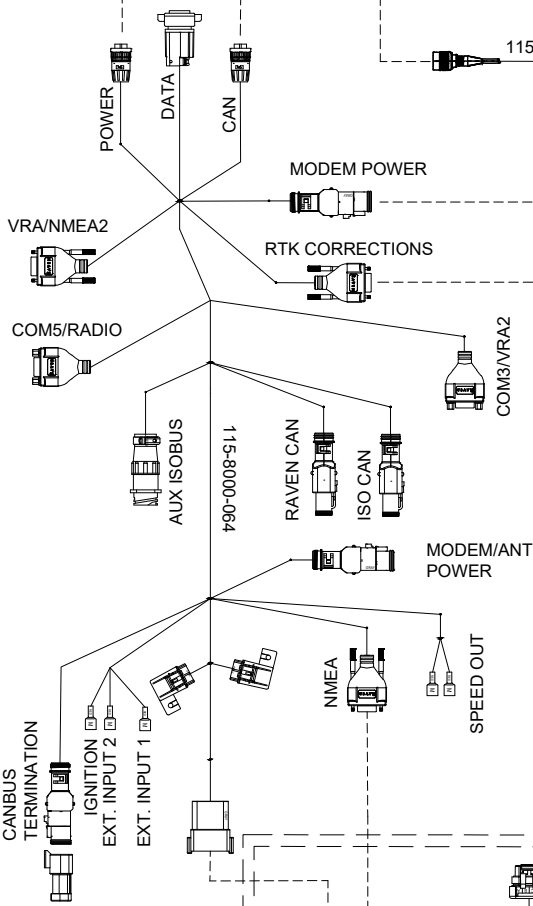
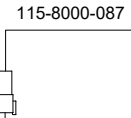
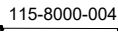
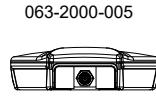
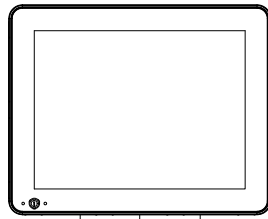

KIT, INSTALL, VIPER4(+)/CR12, INTERNAL GPS, SLINGSHOT  
117-8000-241/-244

KIT, JOHN DEERE AUTOTRAC READY  
6000 SERIES, SBGUIDANCE, W/ IBBC  
117-8000-170

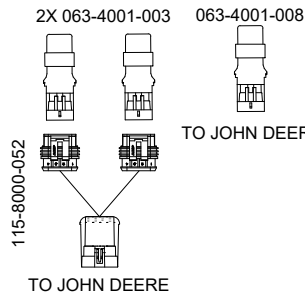
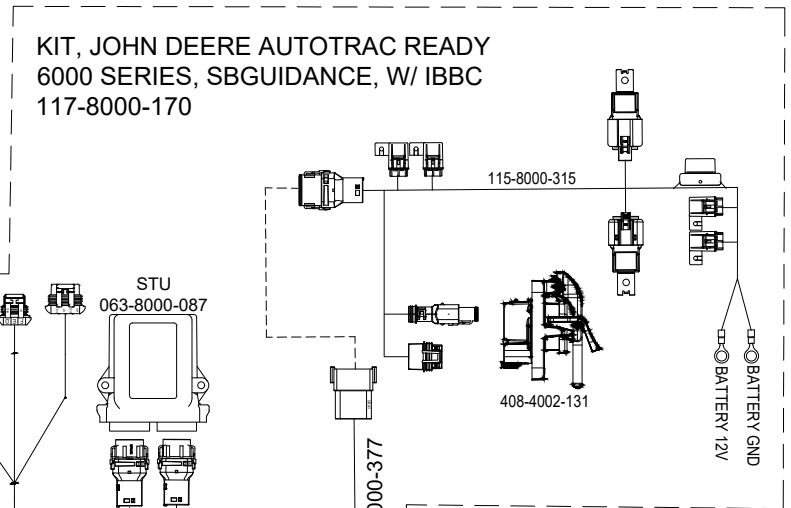

SHEET 2 OF 3

RELEASED DATE	ECO #	REV.	DRAWING NO.
11/2/20	36260	A	054-8000-170

# SYSTEM DRAWING, JOHN DEERE AUTOTRAC READY 6000 SERIES, SBGUIDANCE, W/ IBBC, INTERNAL GPS, RADIO

KIT, CONSOLE, VIPER 4+ SBG, RADIO  
117-8000-270/-272/-274/-276

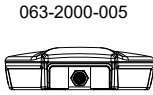
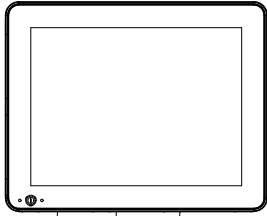

KIT, RADIO ANTENNA  
117-8000-313

121-8000-008

115-8000-004

115-8000-106

COM5/RADIO RTK CORRECTIONS

POWER

DATA

CAN

MODEM POWER

VRA/NMEA2

COM3/VRA2

AUX ISOBUS

RAVEN CAN

ISO CAN

MODEM/ANT POWER

KIT, INSTALL, VIPER4(+)/CR12, INTERNAL GPS, RADIO  
117-8000-236/-243

KIT, JOHN DEERE AUTOTRAC READY 6000 SERIES, SBGUIDANCE, W/ IBBC  
117-8000-170

CANBUS TERMINATION

IGNITION

EXT. INPUT 2

EXT. INPUT 1

NMEA

SPEED OUT

2X 063-4001-003

063-4001-008

115-8000-052

TO JOHN DEERE

063-0174-070

115-8000-410

115-8000-063

115-8000-252

STU  
063-8000-087

115-8000-382

115-8000-377

115-8000-315

408-4002-131

BATTERY 12V  
BATTERY GND

SHEET 3 OF 3

RELEASED DATE	ECO #	REV.	DRAWING NO.
11/2/20	36260	A	054-8000-170